

INSTRUCTIONS

The document has been formatted for double sided printing. The blank pages throughout the document are intentional.

To properly print this document, this instructional page must first be deleted from the PDF. This can be accomplished by pressing Shift-Ctrl-D.

This document has also been formatted with bookmarks to aid in navigation. Bookmarks can be access from the Main Menu by selecting View / Navigation Panels / Bookmarks.



BMP

Manual of Best Management Practices For Stormwater Quality



a u g u s t
2 0 0 9
second edition



Clean Water. Healthy Life.
Regional Water Quality Education Program



MID-AMERICA REGIONAL COUNCIL
AND
AMERICAN PUBLIC WORKS ASSOCIATION



Manual of Best Management Practices For Stormwater Quality

Final

August 2009

TABLE OF CONTENTS

<u>Section</u>	<u>Page</u>
EXECUTIVE SUMMARY	1
1.0 INTRODUCTION	1-1
1.1 BACKGROUND	1-1
1.2 GOALS AND OBJECTIVES	1-1
1.3 BRIEF DESCRIPTION OF MANUAL	1-2
1.4 FORMAL ADOPTION OF THIS MANUAL	1-3
2.0 DEFINITIONS	2-1
3.0 PRINCIPLES OF STORMWATER MANAGEMENT	3-1
3.1 STORMWATER MANAGEMENT GOALS	3-1
3.2 WATER QUALITY CONCEPTS	3-2
3.3 TREATMENT TRAIN	3-3
3.4 OTHER REFERENCES AND DESIGN SOURCES	3-8
4.0 BMP SELECTION CRITERIA	4-1
4.1 DEVELOPMENT CONDITIONS	4-1
4.2 THE LEVEL OF SERVICE METHOD.....	4-1
4.3 ADJUSTMENTS FOR INCREASED WATER QUALITY	4-13
4.4 ADDITIONAL PRACTICES FOR STORMWATER "HOT SPOTS"	4-15
5.0 INITIAL MEASURES AND MINIMUM PRACTICES	5-39
5.1 STREAM BUFFERS	5-39
5.2 SOIL PRESERVATION AND RESTORATION	5-39
5.3 BIORETENTION	5-2
5.4 ELIMINATE DIRECT CONNECTIONS	5-2
5.5 REGULATE "HOT SPOTS"	5-2
6.0 HYDROLOGY METHODS	6-1
6.1 GENERAL	6-1
6.2 SHORT-CUT METHOD	6-1
6.3 SMALL STORM HYDROLOGY METHOD	6-1
6.4 RATIONAL METHOD.....	6-2
7.0 GENERAL GUIDANCE FOR NON-STRUCTURAL BMPS	7-1
7.1 SOIL MANAGEMENT - PRESERVATION	7-2
7.2 SOIL MANAGEMENT - RESTORATION	7-4
7.3 RESTORATION OF NATIVE VEGETATION	7-6
7.4 UPLANDS	7-9
7.5 BOTTOMLANDS AND FLOODPLAINS	7-10
7.6 STREAM BUFFERS	7-12
8.0 GENERAL GUIDANCE FOR STRUCTURAL BMPS: ENGINEERED SYSTEMS	8-1
8.1 RAIN GARDENS.....	8-1
8.2 FILTRATION BASINS	8-6
8.3 INFILTRATION TRENCHES.....	8-9
8.4 BIORETENTION	8-14

8.5 PERMEABLE PAVEMENT	8-34
8.6 EXTENDED DETENTION WETLAND	8-40
8.7 SAND FILTER.....	8-60
8.8 WETLAND SWALES.....	8-67
8.9 BIOSWALES.....	8-73
8.10 EXTENDED WET DETENTION.....	8-76
8.11 NATIVE VEGETATION SWALE.....	8-99
8.12 EXTENDED DRY DETENTION BASIN.....	8-108
8.13 TURF SWALES.....	8-128
8.14 PROPRIETARY MEDIA FILTRATION	8-133
8.15 HYDRO DYNAMIC SEPARATION.....	8-136
8.16 CATCH BASIN INSERTS	8-138
8.17 BAFFLE BOXES & OIL/GRIT SEPARATORS	8-140
8.18 VEGETATED FILTER STRIP	8-142
9.0 LINKS TO OTHER PROGRAM REQUIREMENTS.....	9-1
9.1 PHASED CONSTRUCTION	9-1
9.2 SEDIMENT AND EROSION CONTROL PLANS	9-1
10.0 REFERENCES.....	10-1

APPENDIX A - EXAMPLE SPECIFICATIONS

APPENDIX B - POLLUTION CONTROLS FOR “HOT SPOTS”

APPENDIX C - ANALYSIS OF TREATMENT SYSTEM PREFERENCE

LIST OF FIGURES

<u>Figure</u>	<u>Page</u>
3.1 Natural Treatment Processes	3-3
3.2 Hierarchy of Stormwater Best Management Practices.....	3-5
3.3 Stages of a Treatment Train	3-7
4.1 Determining If Development Requirements Stormwater Quality Management	4-3
4.2 Determining Stormwater Quality Management Requirements	4-4
4.3 Soils And Development Summary.....	4-23
4.4 Example 1 BMP Package 1	4-24
4.5 Example 1 BMP Package 2	4-25
4.6 Example 1 BMP Package 3	4-26
4.7 Proposed Development.....	4-31
4.8 Example 2 BMP Package 1	4-32
4.9 Example 2 BMP Package 3	4-33
4.10 Example 2 BMP Package 4	4-34
4.11 Example 3 BMP Package 1	4-37
4.12 Example 3 BMP Package 2	4-38
7.1 Stream Buffer Zone Placement Example.....	7-14
8.1 Rain Garden Layout for Parking Lot Runoff	8-5
8.2 Simplified Cross Section of Rain Garden Design.....	8-5
8.3 Typical Infiltration Basin	8-8
8.4 Infiltration Trench Plan and Profile Example	8-13
8.5 Bioretention Plan and Profile.....	8-24
8.6 TSS Removal Efficiency of and EDW	8-50
8.7 "V" Notch Weir Outlet Structure	8-58
8.8 WQ _v Outlet Orifice Plate and Trash Rack Design	8-59
8.9 WQ _v Outlet Trash Rack Design.....	8-60
8.10 Surface Sand Filter Plan and Profile Example	8-63
8.11 Underground Sand Filter Plan and Profile Example.....	8-64
8.12 Pocket Sand Filter Plan and Profile Example.....	8-65
8.13 Wetland Swale Plan And Profile Example.....	8-69
8.14 Wetland Swale	8-72
8.15 Typical Wetland Swale Cross Section.....	8-73
8.16 Typical Bioswale Section	8-75
8.17 "V" Notch Weir Outlet Structure (2)	8-97
8.18 WQ _v Outlet Trash Rack Design (2).....	8-98
8.19 WQ _v Outlet Trash Rack Design (2).....	8-99
8.20 Swale Plan and Profile Example	8-101
8.21 Typical Native Vegetation Swale Ditch Check	8-105
8.22 Schematic of an EDDB	8-112
8.23 Standpipe Outlet Structure.....	8-124
8.24 "V" Notch Weir Outlet Structure (3)	8-125
8.25 WQ _v Outlet Trash Rack Design (3).....	8-126
8.26 WQ _v Outlet Trash Rack Design (3).....	8-127
8.27 Vegetative Filter Strip.....	8-143

LIST OF TABLES

<u>Table</u>	<u>Page</u>
4.1 Common Cover Types and Curve Numbers	4-7
4.2 LS for Previously Undeveloped Sites	4-8
4.3 Required Level of Service for Previously Developed Sites	4-9
4.4 Best Management Practice Value Ratings	4-10
4.5 Value Rating Calculations	4-11
4.6 Composite Value Ratings for 2 BMPs in Series	4-14
6.1 Volumetric Coefficients for Urban Runoff	6-2
6.2 Reduction Factors to Volumetric Runoff Coefficients for Disconnected Impervious Surfaces	6-2
6.3 Rainfall Intensity for Water Quality Rainfall Event	6-3
6.4 Unimproved Channel Velocity	6-4
7.1 Planting Densities for Stormwater BMPs	7-7
7.2 Stream Buffer Widths	7-13
8.1 Typical Maintenance Activities for Rain Gardens	8-4
8.2 Vegetated Pretreatment Strip Sizing Guidance	8-23
8.3 Vegetated Pretreatment Channel Sizing Guidance for a 1.0-Acre Tributary Area	8-23
8.4 Volume Allocations in Extended Detention Wetlands	8-50
8.5 Design Summary for Wetland Swales	8-71
8.6 Design Summary for Bio Swales	8-76
8.7 Threshold Tributary Areas to EWOB	8-87
8.8 Design Summary for Native Vegetation Swales	8-103
8.9 Design Summary for Turf Swales	8-129
8.10 Pollutant Groups Targeted by Common Media Types	8-134

EXECUTIVE SUMMARY

EXECUTIVE SUMMARY

The Kansas City Mid-America Regional Council (MARC) and the Kansas City Metro Chapter of the American Public Works Association (APWA) have developed this manual as a guide for applying stormwater Best Management Practices (BMP) to land development within the Kansas City Metropolitan Area and the MARC planning region. The manual addresses the need to control the volume and quality of stormwater discharges from developed sites, both of which are crucial requirements for protecting human life and property, maintaining overall water quality, and for creating more environmentally sensitive site designs. The authors envision use of this manual alone or in conjunction with the guidelines in Division V of American Public Works Association (APWA) Section 5600, *Storm Drainage Systems & Facilities* design criteria. Communities participating in the program can use state-of-the-art stormwater management practices to meet water quality regulations such as the NPDES Phase II requirements, reduce flooding, conserve water, protect wildlife habitat, and create community amenities.

This manual furnishes clear, understandable guidance for planning and implementing BMPs. It describes how to determine potential water quality impacts and how to select BMPs most appropriate for mitigating those impacts. This manual is based on widely-accepted water quality protection, BMP design, and BMP application guidance from sources throughout the U.S. It adapts this information for use in the Kansas City region. The information includes:

- Definitions for BMPs and water quality treatment concepts
- Stormwater management goals and concepts
- A regionally based procedure for selecting and applying BMPs for a development
- A recommended program of minimum BMPs for all municipalities
- Methods of performing hydrologic calculations for design of water quality treatment
- BMP descriptions and design guidance
- Complete design specifications and standard details for several widely applicable BMPs.

A basic goal for all developments is to maintain predevelopment peak flows, runoff volumes, and water quality. In other words, development should maintain the velocity and quantity of runoff and the amount of pollutants leaving the site, unless the effects are fully considered and documented in the design or unless site conditions apply that require more stringent measures.

Stormwater management proceeds from thorough site analysis to planning and site design, and is unique for each site and development project. The first step in water quality management is to maintain or reduce the amount of runoff generated within a watershed by maintaining watershed hydrology and cover. Treatment is then applied to the remaining runoff to remove some of the pollutant load. BMPs are the key to both approaches and may be non-structural (preserved soils; preserved or established open space and native vegetation; stream buffers) or structural (infiltration, filtration, and extended detention practices designed specifically for water quality treatment).

The "Level of Service Method" presented in this manual was developed specifically for the MARC region. This seven step method for selecting and applying BMP's to development sites utilizes numeric calculations to account for changes in pre to post developed conditions, as reflected by the difference in curve numbers of the two conditions. This difference determines the resultant Level of Service (LS) requirement. LS is indicative of development impacts, which must be mitigated by the site design and incorporation of BMP's. Details of this process are provided in **Section 4**.

Intended as a regional guidance document, this manual is a reference for BMP application and design. Communities may choose to mandate some or all of its provisions, design criteria and specifications. Jurisdictions are encouraged to adopt this manual in its entirety for maximum benefit and consistency. Those that adopt part of this manual may consider adopting the Initial Measures and Minimum Practices (**Section 5**), along with the hydrologic calculations, design criteria, and specifications for minimum BMPs from **Sections 6 through 8** and **Appendix A**. Jurisdictions that use this document as a BMP design manual only should consider adopting the implementation portion (**Sections 6 to 8** and **Appendix A**).

Section 1

Introduction

1.0 INTRODUCTION

The purpose of this manual is to facilitate the design and application of stormwater Best Management Practices (BMP) in land development projects within the Kansas City Metropolitan Area and the Mid-America Regional Council (MARC) planning region. The BMP Manual enhances APWA 5600 and helps communities comply with Federal and state water quality regulations.

In 1972, the National Pollutant Discharge Elimination System (NPDES) program was established under the Clean Water Act. NPDES Phase I and Phase II require communities to develop, implement, and enforce a program to reduce pollutants in runoff from new development and redevelopment projects. The manual provides developers and designers with flexible tools which control the volume and quality of stormwater discharges –important for maintaining water quality in our streams, rivers and lakes. Use of this manual alone or in conjunction with the guidelines in Division V of APWA Section 5600 stormwater design criteria can provide a unified, up-to-date strategy for managing stormwater quantity and quality. Unified stormwater management can protect life, property, and the environment, while improving the quality of life for the citizens of the Kansas City region.

As the first attempt to describe state-of-the-art water quality protection practices for the MARC region, the original BMP Manual, developed in 2003, was based on current (though occasionally limited) knowledge. Therefore, the BMP manual was, and continues to be, viewed as a “living document” to be updated periodically with advances in water quality protection practices. This version of the manual is the first update to the original document. The most significant changes include a revised BMP list with updated Value Ratings and an expanded native plant section. Indeed, future versions will reflect lessons learned from implementing the methods and practices currently recommended in this manual– particularly those involving water quality monitoring data and performance assessments.

1.1 BACKGROUND

Recent regional flood events, recognition of the impacts of developed and rapidly developing areas on water quantity and quality issues, and the desire to preserve and protect environmental quality while creating community amenities were the driving forces behind the development of this manual. This manual is an important component of a regionally based program dedicated to combining community planning, engineering design, landscape design and environmental management for the promotion of more environmentally sensitive site designs which reflect an integrated, watershed-based approach to stormwater management. Based on the fact that flood control and water quality are both integral aspects of stormwater management, the guiding philosophy of this program is to “Manage Stormwater Quantity and Protect Water Quality.”

Use of stormwater BMPs is one way to address these two intertwined issues. The term “BMP” originated in the agriculture industry as a reference to practices that reduce farmland erosion and improve crop yield. In the broadest sense, a stormwater BMP is any action or practice aimed at reducing flow rates and pollution concentrations in urban runoff. Examples include site planning practices, public education efforts, open space preservation, pollution prevention practices, and engineered natural treatment systems. This manual describes two classes of BMPs: non-structural and structural. Non-structural controls minimize contact of pollutants with rainfall and runoff. Structural controls are facilities constructed for treating stormwater runoff (Texas Chapter, APWA [Texas APWA] 1998).

1.2 GOALS AND OBJECTIVES

Two primary goals of this integrated stormwater approach are to (1) balance future development with environmental health and quality of life, and (2) comply with water quality regulations such as the National Pollutant Discharge Elimination System (NPDES) Phase II requirements. New, proactive policies and practices are provided in this document which will guide the efforts of municipalities, developers and designers in the achievement of environmentally sound development and resource conservation which will reduce flooding, protect stream corridors, conserve water, improve water quality, preserve wildlife habitat and create community amenities.

This type of balanced development requires we first mitigate and reduce the environmental impact of increased stormwater runoff due to development by controlling the large water quantities produced by developing watersheds and minimizing resulting impairment. Peak flows and overall quantity of stormwater can be maintained, or reduced, after development activities are complete. Stream setbacks, environmentally sensitive site selection and design and the incorporation of BMPs address environmental health and quality of life issues. BMP's, in particular, can improve stormwater quality by mitigating extreme pH values and assisting removal of sediment, petroleum-based materials, biochemical oxygen demand (BOD), metals, bacteria, nutrients, toxic organic compounds, and other substances that may be present in harmful concentrations. Communities adopting these goals and objectives can use state-of-the-art stormwater management practices to meet water quality regulations such as the NPDES Phase II requirements.

1.3 BRIEF DESCRIPTION OF MANUAL

This manual furnishes clear, understandable guidance for planning and implementing BMPs. It describes how to determine potential water quality impacts and how to select BMPs most appropriate for mitigating those impacts. It also describes uses, effective placements, and likely effects of BMPs. Developers of entire communities, individual homeowners, and businesses can use these BMPs. Guidance on water quality protection, BMP design, and BMP application from sources throughout the U.S. are included. This information was adapted for use in the Kansas City region and includes:

- Definitions for BMPs and water quality treatment concepts
- Stormwater management goals and concepts
- A regionally based procedure for selecting and applying BMPs for a development
- A recommended program of minimum BMPs for all municipalities
- Methods of performing hydrologic calculations for design of water quality treatment
- General BMP descriptions and design guidance
- Complete design specifications and standard details for several widely applicable BMPs.

The first half of the manual, **Sections 2** through **5**, provides general information:

- **Section 2** lists definitions of BMPs and other stormwater management terms.
- **Section 3** discusses stormwater management goals and concepts, and the "treatment train" approach for placing BMPs in series for additional water quality improvements. As well, this section cites additional BMP application and design guidance documents pertinent to the Kansas City region.
- **Section 4** identifies developments that should meet stormwater management goals. Section 4 also provides the recommended procedure for quantifying postdevelopment impacts on a site and selecting a stormwater management system to mitigate those impacts.
- **Section 5** describes the basic measures for treating water quality that should be considered as part of a minimum program.

The second half of the manual, **Sections 6 -10**, includes "nuts and bolts" information on BMP selection and design:

- **Section 6** describes the method for modeling hydrology for water quality improvement and BMP design.
- **Sections 7 and 8** provide general selection and design criteria for non-structural and structural BMPs.
- **Section 9** describes how to tie sediment controls, erosion control, and other regulatory programs into the stormwater management system.
- **Section 10** provides a detailed list of references used in the preparation of this document.

1.4 FORMAL ADOPTION OF THIS MANUAL

Intended as a regional guidance document, this manual is a reference for BMP application and design. Communities may choose to mandate some or all of its provisions, design criteria and specifications. Jurisdictions are encouraged to adopt this manual in its entirety for maximum benefit and consistency. Those that adopt part of this manual may consider adopting the Initial Measures and Minimum Practices (**Section 5**), along with the hydrologic calculations, design criteria, and specifications for minimum BMPs from **Sections 6 through 8** and **Appendix A**. Jurisdictions that use this document as a BMP design manual only should consider adopting the implementation portion (**Sections 6 to 8** and **Appendix A**).

Section 2

Definitions

2.0 DEFINITIONS

Best Management Practice (BMP): Stormwater management practice used to prevent or control the discharge of pollutants and minimize runoff to waters of the U.S. BMPs may include structural or non-structural solutions, a schedule of activities, prohibition of practices, maintenance procedures, or other management practices.

Bioretention: Small engineered and landscaped basins intended to provide water quality management by filtering stormwater runoff before release into stormdrain systems.

Curve Number (CN): A runoff coefficient developed in the U.S. Natural Resource Conservation Service (NRCS) family of hydrologic models by combining land use and one of four hydrologic soil types on a parcel of land.

Detention Storage: The volume occupied by water below the level of the emergency spillway crest during operation of a stormwater detention facility.

Emergency Spillway: A device or devices for discharging water when inflow exceeds designed outflow from a detention facility. The emergency spillway can prevent damage to the detention facility from sudden release of impounded water.

Extended Dry Detention Basin: Any detention facility, vegetated with native plants, designed to permit no permanent impoundment of water but designed to detain the water quality volume for forty (40) hours.

Extended Detention Wetland: A land area that is permanently wet or periodically flooded by surface or groundwater, and has developed hydric soil properties that support vegetation growth under saturated soil conditions. It may have been engineered with adequate capacity to detain large storm flows.

Extended Wet Detention Basin: Any detention facility designed to include a permanent pool and designed to detain the water quality volume for forty (40) hours.

Filter Strip: A grassed area that accepts sheet flow runoff from adjacent surfaces. It slows runoff velocities and filters out sediment and other pollutants. Filter strips may be used to treat shallow, concentrated, and evenly distributed storm flows.

First Flush: The quantity of initial runoff from a storm or snowmelt event that commonly contains elevated pollutant concentrations. Often the first flush contains most of the pollutants in drainage waters produced by the storm event.

Floodplain: A relatively level surface that is submerged during times of flooding. Located at either side of a watercourse, it is composed of stratified alluvial soils built up by silt and sand carried out of the main channel. Activities within floodplains are often regulated by Federal Emergency Management Agency (FEMA) or other regulatory agency.

Hydrologic Soil Group (HSG): NRCS soil grouping according to minimum infiltration rate, or the capacity of soil (absent vegetation) to permit infiltration. Soils are grouped from HSG A (greatest infiltration and least runoff) to D (least infiltration and greatest runoff).

Impact Stilling Basin: A pool placed below an outlet spillway and designed for reducing discharge energies in order to minimize downstream erosive effects.

Impervious Surface: A surface that prevents infiltration of water.

Infiltration: Percolation of water into the ground.

Infiltration Practices: A system allowing percolation of water into the subsurface of the soil. This may recharge shallow or deep groundwater. Basins or trenches may serve as key components of this system.

Infiltration basins: Earthen structures that capture a certain stormwater runoff volume, hold this volume, and infiltrate it into the ground over a period of days.

Infiltration trenches: Small, excavated trenches filled with coarse granular material; they collect first flush runoff for temporary storage and infiltration.

Level of Service (LS): The level of water quality protection recommended for a development or provided by a postdevelopment stormwater management system. The LS requirement for the development is determined by the change in runoff from the predevelopment condition. The LS provided by the stormwater management system is determined by a combination of detention and water quality treatment.

Level Spreader: A structural practice of redistributing concentrated flows to sheet flow over a wide area to minimize erosive velocities, and to increase infiltration and treatment potential.

Media Filtration Practices: Suitable only for runoff from highly impervious stabilized areas these filters consist of a pretreatment area or chamber in conjunction with a self-contained bed of sand used to treat wastewater or diverted stormwater runoff; the water subsequently is collected in underground pipes for additional treatment or discharge.

Surface Sand Filter: Surface sand filters (sometimes referred to as Austin sand filters) use an off-line sediment chamber to collect the first flush of stormwater with larger flows being diverted around the sedimentation chamber.

Perimeter sand filter: Perimeter sand filters use a two-chamber concrete vault and are typically used in a linear application, such as the perimeter of a parking lot.

Underground: Underground sand filters (also called Washington D.C. sand filters) use a three-chamber concrete vault placed at or beneath grade with the existing ground surface.

Pocket: Pocket sand filters (also called Delaware sand filters) are simplified surface sand filters only applicable to small sites. Stormwater must be pretreated by a sediment basin, filter strip, or other means.

Native Soil and Vegetation Preservation: The practice of preserving land areas containing soil profiles and vegetation that have adapted to the climate, hydrology, and ecology of the area to minimize the impacts of development.

Native Vegetation: This term refers to plant types historically located in this geographic area as part of the tall grass prairie, riparian woodland, and oak-hickory forest plant communities. These plant species have not undergone change or improvement by humans, and are still found growing in uncultivated or relatively undisturbed areas within this region. Due to their historic presence, these plant species are extremely well adapted to the climate and natural disturbances (e.g., fire, grazing, and/or flooding) of the region. Furthermore, these plant species have co-evolved with a suite of insects, microbes, and other wildlife. As a result, the grasses, wildflowers, sedges, forbs, shrubs, and trees of these plant communities are drought tolerant, disease and insect resistant, and hardy. Preserved vegetation includes protection of the plant material, as described herein, from destruction and damage, including soil compaction and inundation of sediment. Establishment of native vegetation includes the establishment and maintenance of native plant types and plant associations historically present. Establishment of native plant materials is required if soil treatment is utilized as a BMP.

Natural Channel: Any river, creek, channel, or drainageway that has an alignment, bed and bank materials, profile, bed configuration, and channel shape predominately formed by the action of moving water, sediment migration, and biological activity. The natural channel's form results from regional geology, geography, ecology, and climate.

National Pollutant Discharge Elimination System (NPDES): Defined in Section 402 of the Clean Water Act, this provides for the permit system that is key for enforcing the effluent limitations and water quality standards of the Act. The Phase II Final Rule—published in the Federal Register on December 8, 1999—requires NPDES permit coverage for stormwater discharges from certain regulated, small, municipal, separate storm sewer systems (MS4s) and from land areas greater than 1 acre disturbed by construction.

Pervious Pavement: A type of pavement that allows water to infiltrate the surface layer and enter into a high-void, aggregate, sub-base layer. The captured water is stored in the sub-base layer until it either infiltrates the underlying soil strata or is routed through an underdrain system to a conventional stormwater conveyance system.

Predevelopment: The time period prior to a proposed or actual development activity at a site. Predevelopment may refer to an undeveloped site or a developed site that will be redeveloped or expanded.

Principal Spillway: A device such as an inlet, pipe, or weir used to discharge water during operation of the facility under conditions of the design storm.

Proprietary Systems:

Baffle boxes: Underground retention systems designed to remove settleable solids. There are several water quality inlet designs but most contain one to three chambers. The first chamber provides removal of coarse particles; the second chamber provides separation of oil, grease, and gasoline; and the third chamber provides safety relief if blockage occurs. Frequent maintenance and disposal of trapped residuals and hydrocarbons are necessary for these devices to continuously and effectively remove pollutants.

Catch basin inserts: Catch basin inserts consist of a frame that fits below the inlet grate of a catch basin and can be fitted with various trays that target specific pollutants. Typically the frame and trays are made of stainless steel, cast iron, or aluminum to resist corrosion. The device is typically designed to accept the design flow rate of the inlet grate with bypasses as the trays become clogged with debris.

Hydrodynamic devices: Hydrodynamic devices are engineered systems with an internal component that creates a swirling motion as runoff flows through a cylindrical chamber. The concept behind these designs is that sediments settle out as runoff moves in this swirling path. Typically these devices are prefabricated and come in a range of sizes targeted at specific flow rates. Maintenance requirements include the periodic removal of oil, greases, and sediments, typically by using a vacuum truck.

Media filtration devices: A system that removes pollutants from stormwater by directing the runoff flow through a bed of media contained within a standardized proprietary unit.

Rain Garden: A small depression planted with native wetland and prairie vegetation, rather than a turfgrass lawn, where runoff collects and infiltrates.

Riparian Corridor: Strips of herbaceous and woody vegetation located parallel to perennial and intermittent streams and adjacent to open bodies of water. Riparian Buffers capture sediment and other pollutants in surface runoff water before these enter the adjoining surface waterbody.

Stormwater Detention Facility: Any structure, device, or combination thereof with a controlled discharge rate less than its inflow rate.

Stream Buffer: An area defined by regulatory agencies or municipalities for the protection of riparian corridors and floodplains.

Swale: A depressed area used for stormwater conveyance and/or short term storage.

Bioswale: An open vegetated channel with an engineered soil matrix and underdrain system designed to filter runoff.

Native Vegetation Swale: Native grasses and forbes planted in a swale to reduce velocity of runoff and promote infiltration

Turf Grass Swale: A swale designed to convey stormwater planted with turf grass. Turf grass swales are meant to be used as a substitute for closed drainage systems.

Wetland Swale: An open vegetated channel without underdrains or soil matrix designed to filter runoff and remain wet between rain events.

Treatment Train: The series of BMPs (or other treatments) used to achieve biological and physical treatment efficiencies necessary for removing pollutants from stormwater (or other wastewater flows).

Tree Preservation: Maintenance of existing trees and shrubs.

Total Suspended Solids (TSS): Matter suspended in stormwater excluding litter, debris, and other gross solids exceeding 1 millimeter in diameter.

Uplands: Lands elevated above the floodplain that are seldom or never inundated.

Value Rating (VR): The assumed water quality improvement value of a cover type or BMP, based on its ability to improve water quality and mitigate runoff volume.

Water Quality: The chemical, physical, and biological characteristics of water. This term also can refer to regulatory concerns about water's suitability for swimming, fishing, drinking, agriculture, industrial activity, and healthy aquatic ecosystems.

Water Quality Storm: The storm event that produces less than or equal to 90 percent stormwater runoff volume of all 24-hour storms on an annual basis. In the Kansas City metropolitan area this is the 1.37" storm.

Water Quality Volume (WQv): The storage needed to capture and treat 90 percent of the average annual stormwater runoff volume. It is calculated by multiplying the Water Quality Storm times the volumetric runoff coefficient and site area.

Watershed: All the land area that drains to a given point (also described as a basin, catchment, and drainage area).

Wetland Treatment System: A stormwater or wastewater treatment system consisting of shallow ponds and channels vegetated with aquatic or emergent plants. This system relies on natural microbial, biological, physical, and chemical processes to treat stormwater or wastewater.

Section 3

Principles of Stormwater Management

3.0 PRINCIPLES OF STORMWATER MANAGEMENT

This BMP manual suggests regional stormwater management goals and, in conjunction with APWA Section 5600, provides a package of technical tools for meeting these goals and NPDES Phase II requirements. The stormwater management goals address both water quantity and water quality. The tools provided are based on several basic water quality concepts. In order to effectively utilize the tools provided, stormwater management design must evolve from thorough site analysis to conceptual planning to a site design, which is unique for each site and development project. Proposed stormwater management system design is sensitive to site characteristics including slopes, soil types, cover types, and infiltration capacity. These characteristics should be considered in the site layout to improve both site drainage and water quality. Additional water quality BMPs may be applied to further reduce pollutants in runoff where water quality goals cannot be achieved through site design alone.

Paragraph 3.1 recommends stormwater management goals for the MARC region. Municipalities should start with these goals as a basis for their stormwater management programs, whether or not they formally adopt APWA Section 5600 and this manual. The goals cover both quantity and quality management and provide options for various watershed conditions and levels of stringency. Paragraphs 3.2 and 3.3 discuss water quality concepts upon which this manual is based and explain how these concepts apply to the water quality BMPs developed to meet water quality goals. This section is not comprehensive – more detailed water quality information may be obtained from the following resources:

- Chapter 1 of the *2000 Maryland Stormwater Design Manual, Volume I* from the Maryland Department of Environment includes a good discussion of basic stormwater management concepts.
- *The Stormwater Manager's Resource Center* (www.stormwatercenter.net) is directed to practitioners, local government officials, and others who need technical assistance on stormwater management issues.

Paragraph 3.4 provides references and a brief description for several other BMP manuals.

3.1 STORMWATER MANAGEMENT GOALS

The basic goal of stormwater management is to align water quantity and water quality management techniques in such a way as to prevent further deterioration of our watersheds. For this reason, water quality criteria has been developed to allow more stringent goals. The three basic techniques for addressing these goals include maintaining existing conditions, decreasing peak flows and reducing pollutants. In addition, it is expected that special management goals may apply on a case-by-case basis.

3.1.1 Maintain Existing Conditions

A basic goal for each development is to maintain or improve predevelopment peak flows, runoff volumes and water quality. In other words, development should not increase the velocity or quantity of runoff, or the amount of pollutants leaving the site. Some exceptions are expected, however. For example, limited increases in either volume or discharge velocity may be acceptable if the effects are fully considered in the design, based on a watershed study or other site-specific analysis. Conversely, it may be necessary to exceed the basic goal and reduce storm water impacts—including peak flows and surface water pollutants—in watersheds currently experiencing serious flooding and water quality problems. The following sections discuss circumstances under which deviations from the basic goal would be apt.

3.1.2 Decreased Peak Flow

One goal that has been established is for each development to maintain predevelopment peak flows. In addition, decreased predevelopment peak flow goals apply to watersheds with specified flood control requirements. In this case the goal is defined as a net reduction in the post-development peak discharge velocity and quantity from predevelopment conditions. Local regulations or officials can determine additional flood control requirements using the results of a watershed study, master plan, or Preliminary Engineering Study.

3.1.3 Improved Water Quality

Improved Water Quality is defined as a net reduction in pollutant discharges from a site. This goal is to produce a qualitative improvement in water quality as a result of development (beyond the “do no harm” approach of maintaining existing conditions). It applies where local stormwater design standards are superseded by a state or federal water quality requirements such as a Total Maximum Daily Load (TMDL) or similar state discharge limit for pollutant or water quality indicator. This goal also may be applied where local authorities require water quality improvement. The governing municipality may set more than one tier of improved water quality using the Level of Service Method described in Paragraph 4.3.

3.1.4 Special Management Goals

Special Management Goals are developed on a case-by-case basis, considering the unique characteristics of a watershed or stormwater project. Municipal regulations or the city engineer establishes the water quality or flood control requirements using results of a watershed study, master plan, or Preliminary Engineering Study. Special management goals may apply where an engineering study indicates a unique flooding risk, where local stormwater design standards are superseded by a state or federal water quality requirement (such as a TMDL or similar state discharge limit for pollutant[s] or water quality indicator[s]), or where local regulations require additional water quality improvement.

3.2 WATER QUALITY CONCEPTS

Studies have shown that atmospheric deposition distributes most stormwater pollutants. A full range of pollutants is present in virtually all runoff—whether from yards, roads, or rooftops—because of this atmospheric redistribution. The pollutants are mobilized and impact surface water quality when rainfall produces runoff that carries the contaminants into surface waters. For this reason, impervious surfaces are the major source of stormwater pollutants in urban areas (Claytor and Schueler 1996). Runoff volumes and peak velocities are determined primarily by the site’s cover type and soils, and other factors such as slope, distance, and existing drainage features (USDA 1986). Runoff quantity and water quality are linked, and this linkage forms the basis for this BMP manual.

The first step in water quality management is to maintain or reduce the amount of runoff generated within a watershed. Treatment is then applied to the remaining runoff to remove some of the pollutant load. BMPs are the key to both approaches, as described below.

Preserving a site’s infiltration capacity is a relatively inexpensive non-structural measure to reduce runoff rates, volumes, and pollutant loads. Stormwater runoff rates and volumes and water quality are influenced heavily by infiltration capacity (USDA 1986; Claytor and Schueler 1996). Urbanization shortens a watershed’s response to precipitation mainly by reducing infiltration and decreasing travel time. An impervious surface decreases travel time by preventing infiltration and speeding runoff. Furthermore, faster runoff velocities reduce the opportunity for pollutants to settle out or be removed by natural processes.

Most urban areas are only partially covered by impervious surfaces, however, and natural infiltration rates to underlying soils are influenced primarily by soil type and by plant cover. Any disturbance of a soil profile and cover type can change infiltration characteristics significantly (USDA 1986). Site designs can preserve existing pervious surfaces (open space and vegetation, especially native species), incorporate pervious landscaping and vegetated cover, and reduce and disconnect impervious cover. Pervious cover, and especially vegetation, allows water infiltration that minimizes runoff, erosion, and potential for downstream pollution. Vegetation helps reduce erosion and filters sediment and other pollutants from stormwater runoff by creating a natural buffer to reduce velocity of surface water. Native vegetation and open space provide aesthetic and habitat benefits. Site development practices also can protect soils from compaction and maintain high-quality native soil characteristics. Section 7 discusses non-structural BMPs in considerable detail.

Communities can improve their water quality significantly by treating the remaining runoff volumes with structural BMPs. Structural BMPs are designed to infiltrate and reduce the amount of runoff, or to filter and detain runoff to reduce discharge velocities and remove pollutants. Infiltration galleries represent an example of the former, while bioretention areas (vegetated depressions designed to collect and treat runoff through an engineered matrix of soils

Water Quality Treatment

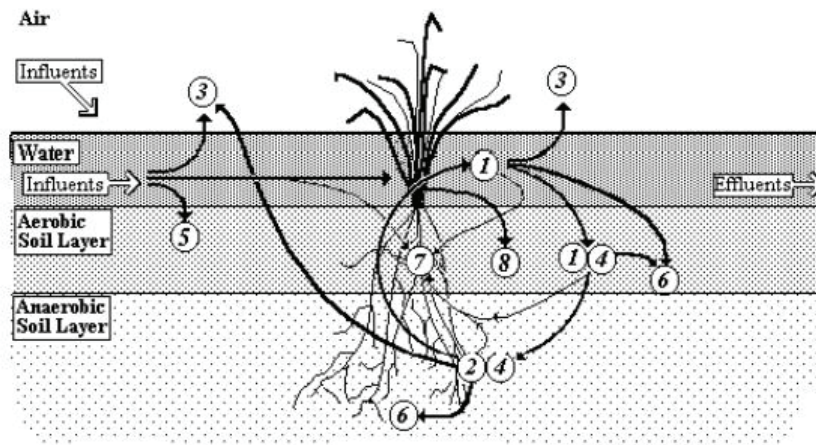

Notes:
Eastlick 2001

- | | | |
|-------------------|------------------|-------------------|
| 1. Oxidation | 4. Adsorption | 7. Plant Uptake |
| 2. Reduction | 5. Sedimentation | 8. Peat Formation |
| 3. Volatilization | 6. Precipitation | |

FIGURE 3.1 - Natural Treatment Processes

and plant roots) represent an example of a filtration practice. As shown in Figure 3.1, filtration and detention BMPs remove pollutants by several processes, including physical settling and filtering by plants and soil media, aeration, adsorption onto soils, and biological processes in the root zone.

Not all runoff contains high concentrations of pollutants, however. The initial rainfall, or “first flush”, mobilizes pollutants that have built up on pervious and impervious surfaces. Thus, pollutants are more concentrated in this “first flush,” with concentrations gradually diminishing as rainfall continues. To be efficient and cost-effective, water quality BMPs must be sized and designed to treat this more concentrated runoff rather than the extreme flood events which are managed by conventional stormwater systems. The design storm for water quality BMPs is the water quality volume (WQv). The WQv is defined as the storage needed to capture and treat 90 percent of the average annual stormwater runoff volume. WQv is a function of the Water Quality Storm, which is the storm event that produces less than or equal to 90 percent volume of all 24-hour storms on an annual basis. In the greater Kansas City Metropolitan area, the Water Quality Storm is the 1.37' rain event.

The following section discusses application of non-structural and structural BMPs.

3.3 TREATMENT TRAIN

A single BMP may not suffice to meet the stormwater management and design objectives for a development. The preferred approach for water quality improvement is a combination or series of stormwater BMPs called a “treatment train.” This set of biological and physical treatments successively removes pollutants from stormwater flows. A

treatment train also can reduce the physical volume of runoff, thus reducing stormwater management costs while improving water quality (Texas APWA 1998).

While many practitioners focus on engineered structural BMPs, a treatment train combines site development strategies, management and housekeeping practices, and engineered solutions. What is not imposed on a site or development can be more important than the applied engineered BMPs. Avoidance is the best strategy to deal with most problems – the most cost-effective practice is to limit the generation of runoff by preserving or creating natural areas and vegetation that soak up precipitation, slow runoff, and filter sediment. Engineered solutions then deal with the remaining runoff volume most effectively at the source. Infiltration and filtration BMPs placed at the source also reduce runoff volumes and peak flows from smaller, more frequent storms (see **Section 6** for a discussion of water quality and hydrology). Finally, what cannot be absorbed or treated at the source must be routed through larger BMPs for detention and treatment prior to discharge from the site. Pollution prevention is also applied so that contaminants are not released from a site where they can be picked up by runoff and carried into surface water bodies. Selection of treatment train components is based on a combination of local and state stormwater requirements, site characteristics, development needs, runoff sources, financial resources, and BMP characteristics (such as space requirements, design capacities, and construction and maintenance costs).

Before choosing a sequence of treatment practices, a planner must understand the site conditions and hydrologic characteristics of the site's drainage area and the requirements for water quality treatment. Most developments are required to manage stormwater peak flows from the site according to Section 5600 or other local regulations; developments also should provide water quality management, as described in this BMP manual or other local regulation. This BMP manual includes guidelines for determining a development's approximate water quality impact and selecting an appropriate BMP package for the site and development. At a minimum, the predevelopment quality of the site must be maintained. The procedure for ranking the predevelopment condition of the site and for selecting a BMP package that will maintain that condition is referred to as the Level of Service (LS) calculation. This procedure includes a method for determining how much treatment a development should include and is described in **Section 4**. Methods for determining site hydrology and for calculating the WQv are described in **Section 6**.

The developer and site design team shall select a combination of practices to meet basic requirements. The "right" treatment train best satisfies stormwater management requirements and project goals and offers the most overall value for the development. Treatment train practices that generally follow the Hierarchy of Stormwater Best Management Practices (see **Figure 3.2**) usually provide the most benefit, at the least cost, with the with greatest flexibility in addressing stormwater needs within the site design. As reflected in **Figure 3.2**, preserving native areas or establishing vegetated open space is commonly the first stage of a treatment train. Undisturbed land or land returned to a natural state through native landscaping, enables greater stormwater infiltration which, in turn, minimizes runoff, erosion, and potential for downstream pollution. A site design which includes disconnected impervious surface areas provides opportunities to address pollutants from rooftops, sidewalks, driveways, parking lots, roadways and so on, in the most efficient manner, close to its origin.

Many suburban or urban sites may have land use, design requirements or other constrains which limit the amount of open space available for stormwater management. These sites may require engineered stormwater infiltration practices and treatment, shown in the middle tier of **Figure 3.2**. These practices and treatment features make up the second stage of the treatment train and control runoff near its source. Examples of infiltration practices include pervious vegetated areas (such as lawns or specially designed filter strips around parking lots and buildings), infiltration trenches and basins, pervious pavement parking lots, and residential rain gardens (Texas APWA 1998). These practices can most efficiently infiltrate site generated runoff and thus substantially reduce runoff that contains pollutants (for example, runoff from the smaller storms such as the Water Quality Storm). Maximizing infiltration results in a reduced peak runoff rate—even from smaller rain events— which decreases demands and stress on downstream control facilities. Peak reduction from reducing impervious surfaces or detaining these smaller events is a function of site and BMP design; it should be calculated and applied by the stormwater designer as part of the design process.

Open space and infiltration practices alone may not sufficiently manage all runoff from a site because of inadequate space, soils and geology, slopes, or other factors. Engineering filtration systems at or near the source of runoff is the next stage of the treatment train. Filtration systems route the most contaminated “first flush” of rainfall through an engineered natural filter. Examples of filtration systems include sand filters, bioretention, wetland swales, and vegetated channels (Center for Watershed Protection 2000b, Claytor and Schueler 1996). These practices also detain smaller rain events, as they are designed to treat the water quality volume.

Designing stormwater detention practices is the last stage of the treatment train. The stormwater engineer or planner should estimate the maximum volume of detention available and required. Detention generally applies to large

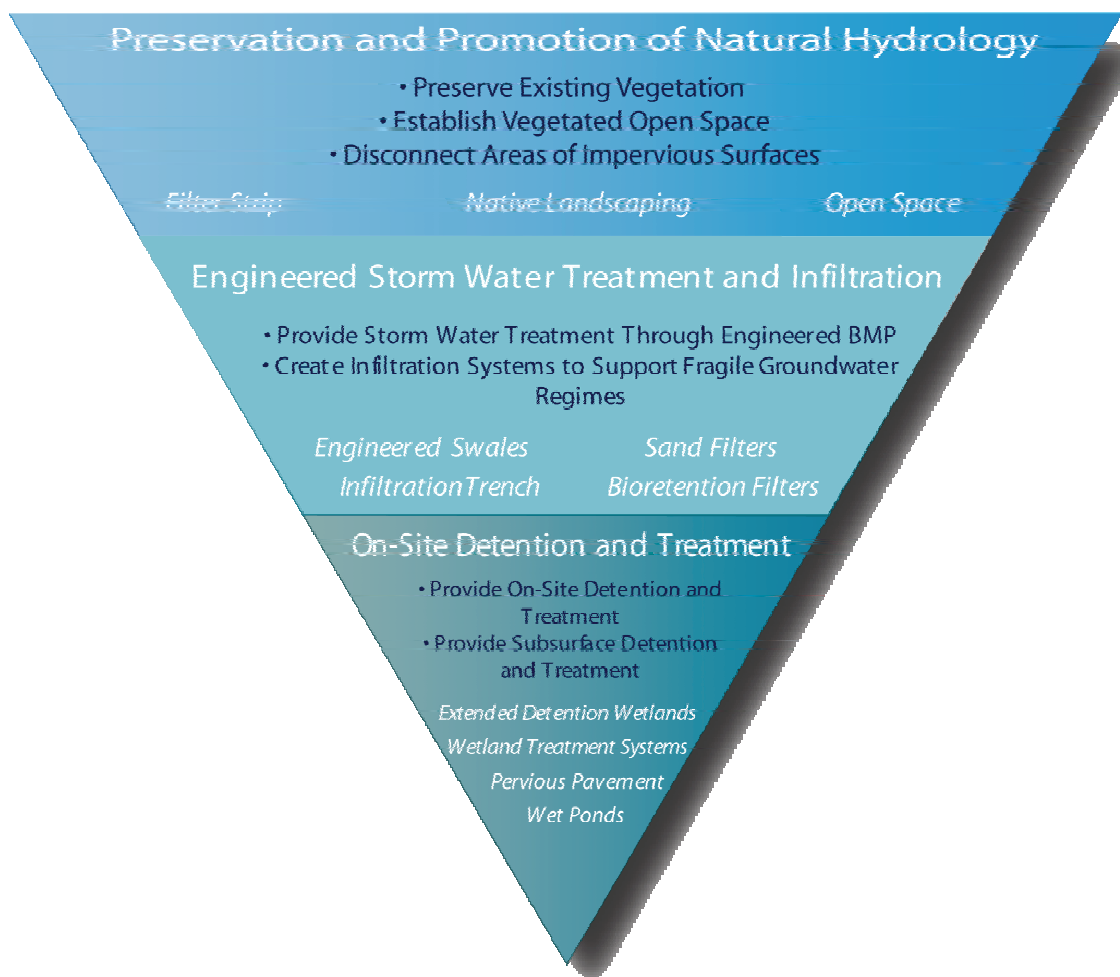

FIGURE 3.2 - Hierarchy of Stormwater Best Management Practices

developments; it provides solutions for sites where space inadequacy precludes stormwater treatment closer to the source. Detention may be the preferred option where predevelopment site conditions are of low quality. Detention basins detain and manage releases from larger rainfall events—usually up to and including the 100-year return interval event — and should include a treatment component sized for the WQv. Many examples and designs are discussed in **Section 8**.

Finally, proper maintenance and pollution prevention practices can further limit stormwater runoff pollution. Routinely cleaning and periodically refurbishing BMPs is necessary for them to function as designed. Maintenance practices (such as sweeping streets and parking lots) remove pollutants before rainfall can enter surface water from spills and

leakage from equipment (Claytor and Schueler 1996). Pollution prevention strategies can contain common sense practices not included in most treatment trains— containment barriers around chemical storage areas to confine potential spills, berms around fueling stations to prevent stormwater run-on, or vehicle and equipment maintenance to prevent leakage (Texas APWA 1998). **Appendix B** includes information on such practices. **Figure 3.3** illustrates an elementary treatment train concept.

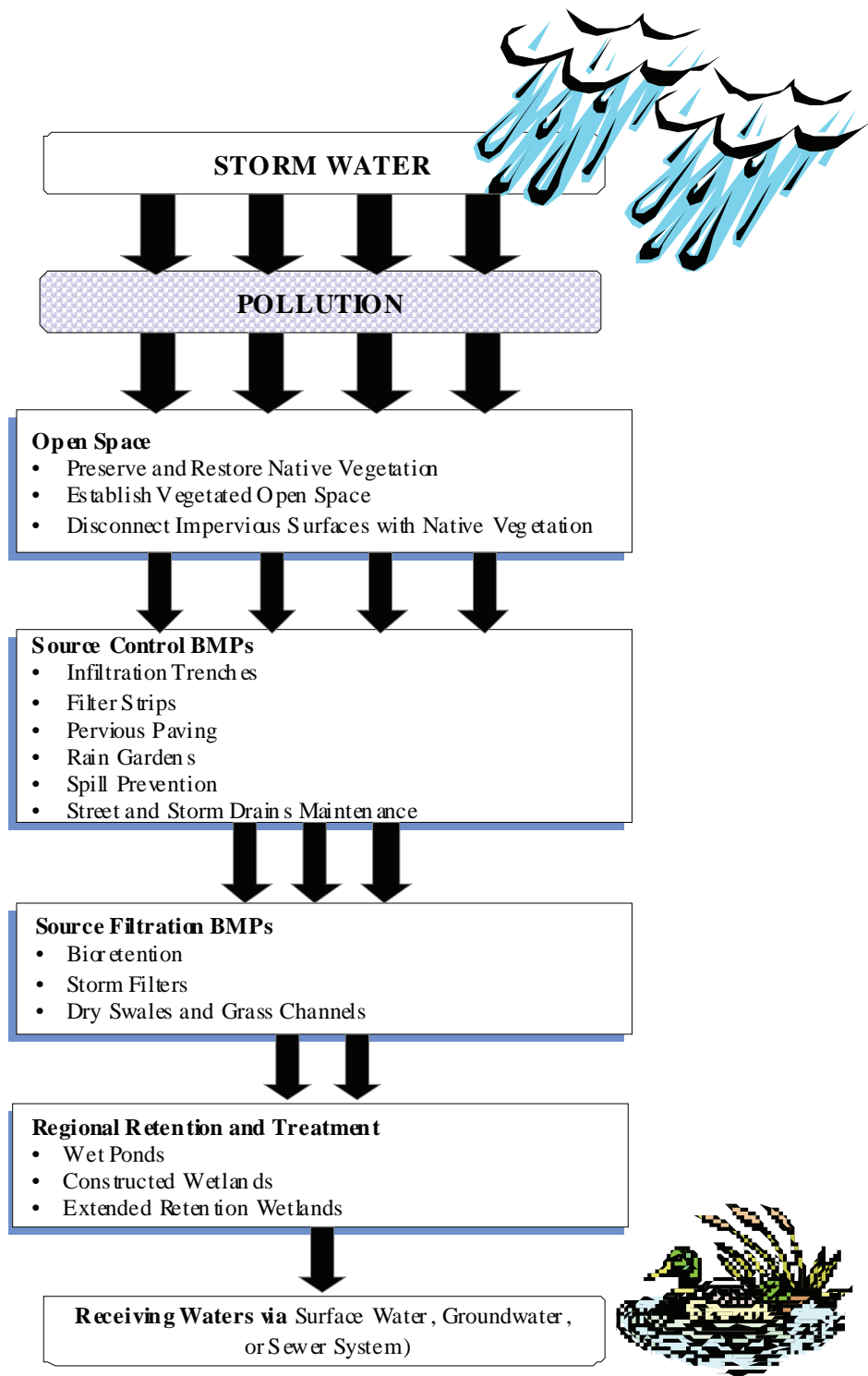

FIGURE 3.3 - Stages of a Treatment Train

The following examples illustrate hypothetical treatment trains for three types of sites:

Residential subdivision: (1) preserve native prairie remnant as common open space; (2) landscape with native vegetation; and (3) use dry swales to convey and treat runoff from landscaped streets and yards.

Commercial development: (1) establish native landscaping in and around buildings and parking areas to break up impervious areas; (2) use bioretention cells in parking lots.

Office park: (1) place filter strips around building downspouts and parking lots, leading to (2) infiltration basins; (3) use dry swales to treat runoff from streets and convey it to (4) a wet pond.

3.4 OTHER REFERENCES AND DESIGN SOURCES

Three useful references for conservation development strategies are:

- Growing Greener Booklet from the National Lands Trust (<http://www.natlands.org/planning/growgreen.html>)
- Better Site Design: A Handbook for Changing Development Rules in Your Community (<http://www.cwp.org/>)
- Low-Impact Development Design Strategies – An Integrated Approach (<http://lowimpactdesign.org/>)

Water quality planners, engineers, and developers may want to consult other manuals and guidance on a case-by-case basis. A number of the better-known methods are described below:

- *2000 Maryland Stormwater Design Manual, Volumes I & II.* Maryland Department of Environment, Water Management Administration. October 2000.

This State of Maryland publication specifies 14 mandatory performance standards that apply to any construction activity disturbing 5,000 or more square feet of earth. The manual provides selection guidance for pretreatment, non-structural BMPs, and structural BMPs designed to remove 80 percent of the average annual post-development total suspended solids load and 40 percent of the average annual post-development total phosphorous load. The redevelopment policy specifies a 20 percent reduction in impervious surface area below existing conditions. Where impractical due to site constraints, this manual requires the use of BMPs to meet the equivalent in water quality control of a 20% decrease in impervious surface area. Additional BMPs are provided for stormwater “hot spots” or highly polluting land uses. This text also includes a good discussion of basic stormwater management concepts.

- Minnesota Urban Small Sites BMP Manual. Metropolitan Council. July 2001.

This manual provides voluntary BMP application and design guidance for small sites (less than 5 acres). The manual furnishes general siting and selection criteria, design guidance, and operation and maintenance recommendations for 40 BMPs—along with relative rankings of each based on treatment suitability, physical feasibility, and community acceptance.

- *Stormwater Management Manual, Revision #2.* The City of Portland, Oregon, Environmental Services Department. September 2002.

The City of Portland requires that all development projects with over 500 square feet of impervious development footprint area, and all redevelopment projects redeveloping over 500 square feet of impervious surface, treat runoff from the additional impervious areas. Portland requires treatment and removal of 70

percent of total suspended solids (TSS) from runoff generated by a design storm up to and including 0.83 inches of rainfall over a 24-hour period. The manual provides a list of acceptable BMPs and simplified sizing and design guidance for each based on the impervious area treated. It also includes a performance-based BMP selection method for designing and customizing BMPs.

- *Texas Nonpoint Source Book*. Texas APWA. 1998. On-Line Address: www.txnpsbook.org.

This web site provides general guidance for various aspects of stormwater management, including water quality concepts, stormwater programs and utilities, and links to other resources. The site also furnishes general planning criteria, design guidance, and operation and maintenance recommendations for a number of BMPs—and relative rankings of each based on treatment suitability, physical feasibility, and community acceptance.

- *Urban Best Management Practices for Nonpoint Source Pollution*. Wyoming Department of Environmental Quality, Water Quality Division. February 1999.

This text is a general reference for water quality principles, and for selecting and applying BMPs geared toward semi-arid climates.

- *Urban Storm Drainage Criteria Manual Vol. 3 – Best Management Practices*. Urban Drainage and Flood Control District, Denver, Colorado. September 1999.

Denver's Urban Storm Drainage Criteria Manual provides water quality management guidance for local jurisdictions, developers, contractors, and commercial and industrial operations. This manual includes discussions of water quality principles and hydrology; in-depth selection and design criteria for a number of BMPs; standard engineering details; operations and maintenance guidelines; and BMP design worksheets. The manual is geared toward semi-arid climates.

Section 4

BMP Selection Criteria

4.0 BMP SELECTION CRITERIA

A number of jurisdictions throughout the U.S. have adopted their own methods for implementing water quality principles into workable development ordinances and design criteria. The “Level of Service Method,” presented in the following sections, is a BMP selection method designed for the greater Kansas City region, which has been based on nationally recognized research and practices.

The Level of Service (LS) Method for BMP selection has been developed specifically for the Eastern Kansas-Western Missouri region; it is based on widely accepted research and applied hydrology from the NRCS, as well as water quality studies compiled from a number of sources (USDA 1986; Claytor and Schueler 1996; CWP 2000a). Municipalities that adopt the LS Method as local design criteria for water quality protection will use the procedure to assess predevelopment and proposed postdevelopment site conditions, and to create a BMP package which achieves stormwater design goals for the site. Other municipalities and developers are encouraged to follow this method when making stormwater management decisions.

Paragraph 4.1 outlines the procedure to determine what stormwater quality design requirements apply to a specific development or stormwater improvement project. Paragraph 4.2 discusses how to use the LS Method to design a water quality protection package which meets the requirements. Paragraph 4.3 discusses options for more stringent water quality protection requirements. Additional guidance for “stormwater hot spots” is provided in Paragraph 4.4. Sections 6 through 8 provide BMP hydrology and design guidelines. LS method worksheets and examples are provided in at the end of **Section 4**.

4.1 DEVELOPMENT CONDITIONS

Stormwater management requirements are based on a combination of the requirements in APWA Section 5600, additional local requirements or exemptions that may apply to general development activities or specific projects, and other watershed-specific conditions (if applicable) such as greater than average flood control needs, water quality impairments (for example, specified TMDLs), or sensitive habitats (for instance, high-quality stream segments). The flow chart in **Figure 4.1** will help determine water quality goals and requirements appropriate for development conditions. It describes levels of water quality protection the governing municipality may require and when special watershed conditions apply. If the development or flood improvement project does not rate an exclusion based on the conditions described in the flowchart, the owner or developer would then determine the postdevelopment level of service (LS) to maintain water quality according to the selection procedure provided in Section 4.2.

The flow chart in **Figure 4.2** outlines the basic process and the process where special requirements apply.

The LS method is intended to maintain existing water quality conditions for developments that increase impervious cover. More stringent requirements may apply where the municipality actively seeks to improve water quality and reduce flooding as development occurs. Communities may seek to decrease peak runoff velocity and/or volume or improve water quality (or both) in specific watersheds or locations, such as where flooding threatens existing structures or where TMDLs necessitate pollutant reductions.

4.2 THE LEVEL OF SERVICE METHOD

The LS refers to the level of water quality protection recommended for a development or provided by a postdevelopment stormwater management system. The LS requirement for the development is determined by the change in runoff as measured by the change in curve number from the predevelopment condition to the postdevelopment condition. The LS provided by the stormwater management system is determined by applying the VR provided by each BMP to the area of the site from which the BMP treats runoff. If the development or project does not meet the definition of development or is otherwise excluded, BMPs are still recommended.

The intent of setting LS is to create a stormwater management system equivalent or superior to that which existed in the site's predevelopment condition through site design and BMPs. Predevelopment condition depends on whether the site or parts of the site are in a developed or developing area and whether the development is new or an incremental improvement to a previously developed site. The selection procedure adjusts for these factors.

The LS Method is outlined below and described in the following paragraphs. Supporting information for selecting site design strategies and BMPs are included as **Tables 4.1** through **4.5**. Worksheets and examples are included at the end of **Section 4**.

To determine the LS for a development, the site must be classified as either undeveloped or redeveloped because different procedures are used for each classification. A project is classified as redevelopment when the existing total impervious surface is 20 percent or more of the total land area of the site, unless determined otherwise by the local jurisdiction. All other sites must follow the procedure for previously undeveloped sites.

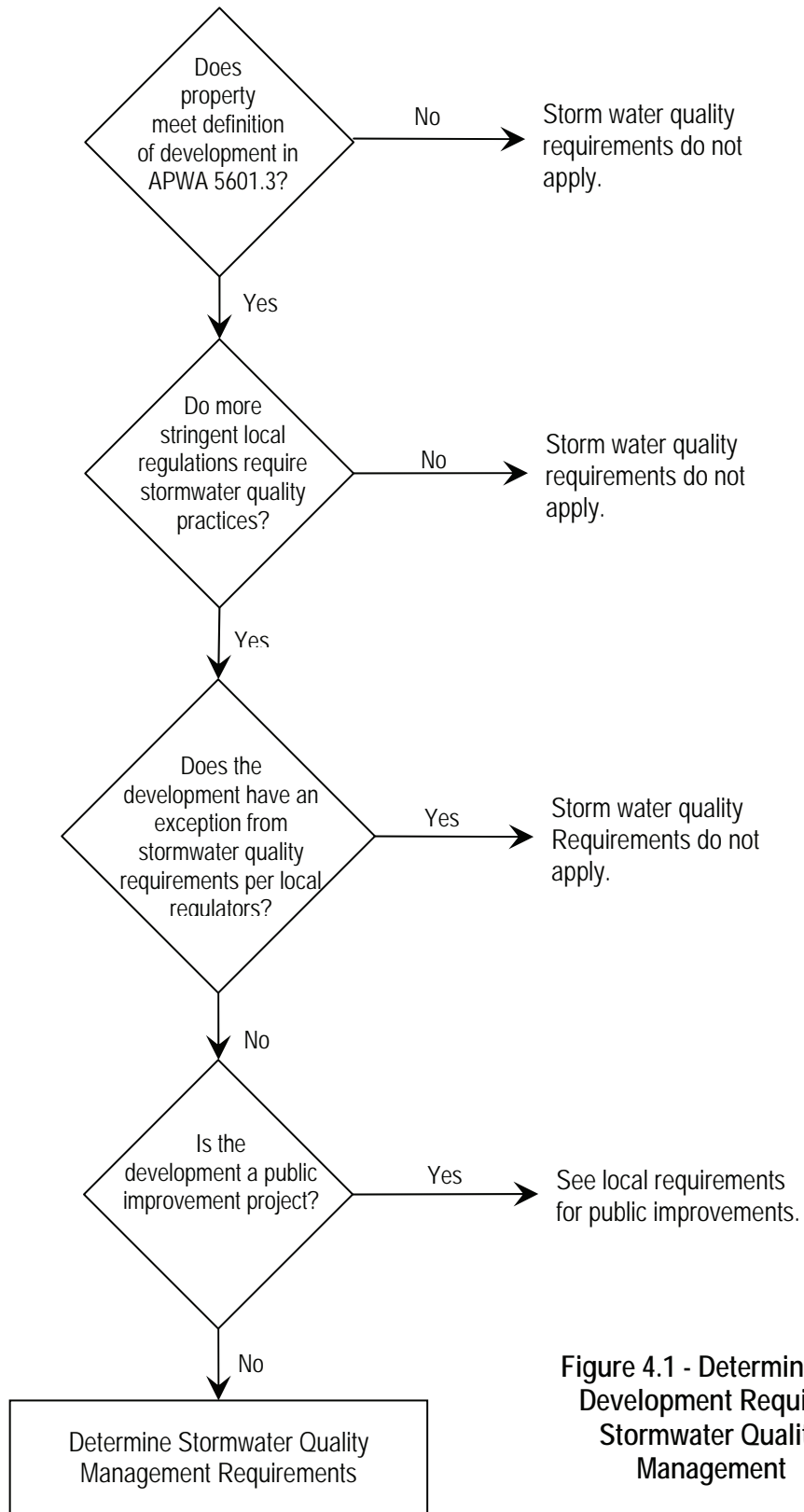
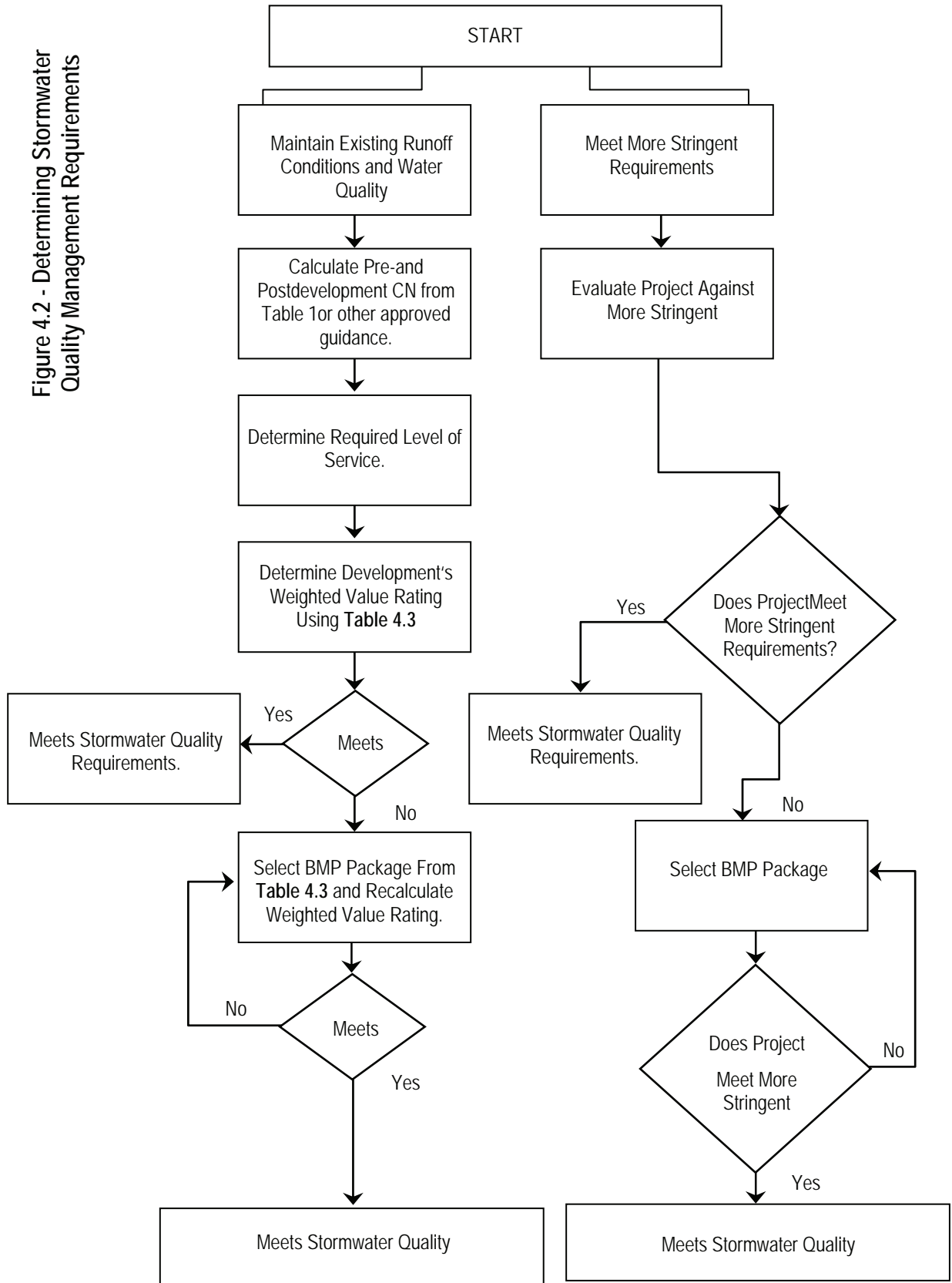

Figure 4.1 - Determining If Development Requires Stormwater Quality Management

Figure 4.2 - Determining Stormwater Quality Management Requirements



The following steps apply to previously undeveloped sites:

- Step 1 - Calculate weighted curve number (CN) for predevelopment conditions using Technical Reference No. 55 (TR-55) from the Natural Resources Conservation Service
- Step 2 - Calculate weighted CN for the proposed development.
- Step 3 - Determine the water quality measures, or LS, that compensates for the difference in predevelopment and postdevelopment CN.
- Step 4 - Calculate the weighted Value Rating (VR) provided by the proposed development, including impervious surfaces, vegetative cover, preserved and created vegetation (analogous to TR-55).
- Step 5 - If the proposed development's weighted VR will not meet the LS, create a Mitigation Package by applying BMP(s) that would receive and treat runoff from specific areas of the site. BMPs may be non-structural or structural.
- Step 6 - Calculate the Mitigation Package weighted VR based on assigned VR for each BMP and the area of the site that the BMP would treat. If the proposed Mitigation Package does not meet the LS, apply different BMPs or apply multiple BMPs in a "treatment train" approach.
- Step 7 - Size and design BMPs for optimum water quality treatment per manual specifications.

The steps differ for previously developed sites that are being incrementally modified, such as adding onto existing buildings, or adding new building(s) or parking:

- Step 1 - Determine the amount of site area to be disturbed by redevelopment activities. Calculate the required area for treatment by subtracting the amount of existing impervious area within the disturbed area from the total disturbed area.
- Step 2 - Calculate the proposed percent impervious for the post-development condition by dividing the net increase in impervious area within the disturbed area by the required area for treatment. Enter **Table 4.3** with the result to determine the required Level of Service.
- Step 3 - Determine the Total Value Rating required for the site in the proposed post-development condition by multiplying the LS by the required area for treatment.
- Step 4 - Calculate the Total Value Rating (VR) provided by the proposed development, including impervious surfaces, vegetative cover, preserved and created vegetation (analogous to TR-55).
- Step 5 - If the proposed development's Total VR will not meet the required VR, create a Mitigation Package by applying BMP(s) that would receive and treat runoff from specific areas of the site. BMPs may be non-structural or structural.
- Step 6 - Calculate the Mitigation Package Total VR based on assigned VR for each BMP and the area of the site that the BMP would treat. If the proposed Mitigation Package does not meet the required Total VR, apply different BMPs or apply multiple BMPs in a "treatment train" approach.
- Step 7 - Size and design BMPs for optimum water quality treatment per manual specifications.

The following sections describe the procedure in more detail.

4.2.1 Predevelopment and Postdevelopment Conditions

This section describes the procedure to determine the required LS for the site development. The required LS is determined by the change in CN or imperviousness resulting from the proposed development, and may be influenced by site design choices and BMPs that are introduced into the proposed development plan (See Section 4.2.2).

Calculate the predevelopment condition for a previously undeveloped site by determining the development site's CN or weighted CN using Worksheet 1 at the end of **Section 4**. The CN is a factor used to estimate stormwater

infiltration and runoff for various combinations of soils and cover types; it is determined using the NRCS CN method described in Technical Release 55 (TR-55) (USDA 1986). The predevelopment site condition is determined from: (1) the original cover type(s) and site quality; (2) the hydrologic soil group (HSG) or groups of underlying soils on site as documented in the NRCS soil survey for the county where development is occurring. Soils on sites developed since publication of the soil surveys are assigned a HSG rating one higher than listed in the soil survey (for example, assign HSG C for listed HSG B). For sites with more than one cover type or HSG, determine a CN for each combination of cover type and HSG, and an area-weighted CN for the entire site. Common cover types and the CN for each are provided in **Table 4.1**, or may be obtained from TR-55, APWA 5602.3, or other sources approved by the governing jurisdiction as applicable.

Use the same method to calculate the postdevelopment condition CN, and then determine the net change in CN from predevelopment to proposed postdevelopment condition. Assume that soils which will be disturbed by development are assigned a HSG rating one higher than the predevelopment condition unless they are preserved in accordance with the specifications in **Appendix A**. A range of LS scores has been assigned to changes in CN as shown below. The LS rating is based on: (1) documented water quality impacts on watersheds with various levels of imperviousness; (2) assumed percent-impervious surface for various developments contained in TR-55 (CWP 2000b, USDA 1986). Determine the LS that the postdevelopment stormwater management system must provide—find the LS that corresponds to the net change in CN on **Table 4.2**.

An LS of 4 signifies no change in CN for undeveloped sites, and a LS of 3 signifies no change in percent of impervious surface for previously developed sites. The lower the LS below 4 for undeveloped sites or below LS 3 for previously developed sites, the greater the benefit of development—the proposed development will decrease runoff and improve water quality, thus lowering the development's need to provide “water quality service.” Examples of this include a predevelopment poor cover type that is stabilized by the postdevelopment cover, and a retrofit of a previously developed urban site to a new land use with a lower percentage of impervious cover. Site plans that maintain or reduce the CN after development and earn an LS of 4 or less, or in the case of a previously developed site that maintains or reduces the percent impervious area, would not meet the definition of development as stated in APWA 5601.3 and would not require additional stormwater BMPs. However, local jurisdictions may have a more stringent definition of development, or may require or encourage BMPs to be considered for all developments, in which cases the lower LS may apply. Examples 1 and 2 at the end of Section 4 illustrate the CN calculation and LS determination for two hypothetical, undeveloped sites.

Important: A reduction of the CN over part of a site reduces the weighted CN for the overall project. Recalculate the postdevelopment CN and change in CN any time the proposed site design changes so the project's LS is adjusted correspondingly.

Incremental improvements to a previously developed site will cumulatively increase runoff and pollutant discharge. In this case, the water quality impact can be determined by analyzing the impact of the new impervious surface on the site within the disturbed area by calculating the percent impervious surface in the proposed post-development condition of the disturbed area. Example 3 at the end of this section illustrates the LS determination for a hypothetical, previously developed site when all treatment alternatives are contained within the disturbed area.

To the maximum extent practicable, the BMPs used to meet the required Level of Service should be located within the disturbed area of the redevelopment site. However, subject to local jurisdiction approval, BMPs may be located elsewhere on the owner's site if they treat previously untreated runoff or form part of a treatment train. Treatment of offsite drainage areas that drain to the site as a method of meeting onsite Level of Service requirements is strongly discouraged and subject to local jurisdiction approval.

TABLE 4.1
Common Cover Types and Curve Numbers

How To Use This Table:

1. This table presents the cover types that a site planner is most likely to encounter, but is not all-encompassing. See TR-55 for additional information.
2. Site planners may substitute curve numbers from APWA 5602.3 or other local regulations, if applicable, to be consistent with hydrology calculations.
3. "Undeveloped" cover types may be used on portions of developed sites where preexisting cover is preserved and protected from disturbance.
4. Postdevelopment HSG is assumed to be one group higher in runoff than predevelopment, unless soil treatment plan is provided to document otherwise. See Appendix A for soil preservation guidance.

UNDEVELOPED				DEVELOPED				
Cover Type	Condition	CN by Hydrologic Soil Group (HSG)			Cover Type	CN by HSG		
		B	C	D		B	C	D
Fallow, bare soil		86	91	94	Parking lots, roofs, streets with sewer, water, etc.	98	98	98
Fallow, crop residue	Poor	85	90	93	Commercial, business	92	94	95
Fallow, crop residue	Good	83	88	90	Streets: paved, open ditch	89	92	93
Straight row crops	Good	78	85	89	Industrial (or office park)	88	91	93
Contoured crops	Good	75	82	86	Newly graded areas	86	91	94
Contoured and terraced crops	Good	71	78	81	Streets: gravel	85	89	91
Pasture	Poor	79	86	89	Streets: dirt	82	87	89
Pasture	Fair	69	79	84	Residential, 1/8-acre	85	90	92
Pasture	Good	61	74	80	Residential, 1/4-acre	75	83	87
Woods-grass	Poor	67	77	83	Residential, 1/3-acre	72	81	86
Woods-grass	Fair	65	76	82	Residential, 1/2-acre	70	80	85
Woods-grass	Good	55	70	77	Residential, 1-acre	68	79	84
Woods	Poor	66	77	83	Residential, 2-acre	65	77	82
Woods	Fair	60	73	79	Open space (turf), poor	79	86	89
Woods	Good	55	70	77	Open space (turf), fair	69	79	84
Meadow		58	71	78	Open space (turf), good	61	74	80
Brush-weeds-grass	Poor	67	77	83	Native grass	58	71	78
Brush-weeds-grass	Fair	56	70	77	Native grass, shrubs and forbs (formal plantings)	56	70	77
Brush-weeds-grass	Good	48	65	73	Native grass, shrubs and forbs (informal plantings)	48	65	73

Source: U.S. Department of Agriculture, Natural Resource Conservation Service Urban Hydrology for Small Watersheds, Technical Release 55 (TR-55; 1986)

TABLE 4.2
LS for Previously Undeveloped Sites

Change in CN	Impact	LS
17 or greater	High water quality impact	8
7 to 16	Moderate water quality impact	7
4 to 6	Low water quality impact	6
1 to 3	Minimal water quality impact	5

A cumulative water quality impact from an increase of one or more ranges of percent impervious cover must be mitigated. The LS ratings corresponding to these increases in range are as follows:

4.2.2 Postdevelopment BMP Selection

This section describes the procedure to create a stormwater management plan that meets the required LS. Water quality protection strategies include site design choices and BMPs. Site design options include minimizing and disconnecting impervious cover using low-impact design. BMPs include both non-structural approaches (such as preserving existing vegetative buffers or establishing native landscaping) and structural approaches (such as installing a wet detention pond, bioretention cell, or engineered swale). Site design that incorporates nonstructural BMPs will reduce the site's postdevelopment CN and may reduce the corresponding LS.

The first step is to determine the water quality protection value of the initial site plan and stormwater management system. Water quality protection value is based on the VR of cover types or BMPs that provide water quality treatment for all or part of the site. The VR ranks a cover type's or BMP's assumed value based on its water quality treatment efficiency and ability to retain stormwater. Higher VRs are given for increased water quality improvement value. **Table 4.4** lists the VR for native vegetation (which includes both preserved existing vegetation or established native landscaping) and for several common classes of structural stormwater BMPs for which design guidance is provided in this manual.

A VR is the sum of several stormwater management factors. The water quality factor rates assumed pollutant removal potential based on the expected median event mean concentrations of total suspended solids (TSS) in discharges from each class of BMP. These rankings were developed from studies in the International BMP Database (www.bmpdatabase.org; *Analysis of Treatment System Performance, International Stormwater Best Management Practices [BMP] Database 1999-2005*, February 2006). Data were available from all BMP classes for TSS, which is one of the most important pollutants to control and is a good proxy for many other pollutants that adsorb to sediment particles. The VR rates three other factors recommended by the U.S. Environmental Protection Agency: (1) volume reduction (i.e. detention and evapotranspiration value); (2) temperature reduction; and (3) oil and floatables reduction, which also addresses some coarse sediments. **Table 4.5** provides the VR rating system and calculations. **Appendix C** includes water quality references.

TABLE 4.3
Required Level of Service for Previously Developed Sites

Proposed % Impervious within Disturbed Area	LS	Proposed % Impervious within Disturbed Area	LS
1	3.1	51	5.6
2	3.2	52	5.7
3	3.2	53	5.7
4	3.3	54	5.7
5	3.4	55	5.7
6	3.5	56	5.8
7	3.6	57	5.8
8	3.7	58	5.8
9	3.7	59	5.8
10	3.8	60	5.8
11	3.9	61	5.9
12	3.9	62	5.9
13	4.0	63	5.9
14	4.1	64	5.9
15	4.2	65	6.0
16	4.2	66	6.0
17	4.3	67	6.0
18	4.4	68	6.0
19	4.5	69	6.1
20	4.6	70	6.1
21	4.7	71	6.1
22	4.8	72	6.1
23	4.8	73	6.2
24	4.9	74	6.2
25	5.0	75	6.2
26	5.0	76	6.2
27	5.1	77	6.3
28	5.1	78	6.3
29	5.1	79	6.3
30	5.1	80	6.3
31	5.2	81	6.4
32	5.2	82	6.4
33	5.2	83	6.4
34	5.2	84	6.1
35	5.2	85	6.4
36	5.3	86	6.5
37	5.3	87	6.5
38	5.3	88	6.5
39	5.3	89	6.5
40	5.4	90	6.6
41	5.4	91	6.6
42	5.4	92	6.6
43	5.4	93	6.6
44	5.5	94	6.7
45	5.5	95	6.7
46	5.5	96	6.7
47	5.5	97	6.7
48	5.6	98	6.8
49	5.6	99	6.8
50	5.6	100	6.8

TABLE 4.4
Best Management Practice Value Ratings

Cover Type or BMP	Median Expected Effluent EMC TSS (mg/L) ^a	Value Ratings				Overall Value Rating
		Water Quality Value	Volume Reduction	Temperature Reduction	Oils/ Floatables Reduction	
Vegetation	N/A	5.25	2	1	1	9.25
Native Vegetation preserved or established						
Rain Garden	< 10	4	2	1	2	9.0
A small residential depression planted with native vegetation designed to capture and infiltrate runoff						
Infiltration Practices	< 10	4	2	1	2	9.0
Infiltration Basin						
Infiltration Trenches						
Bioretention	< 10	4	1.5	1	2	8.5
Small engineered and landscaped basins designed to filter runoff before release						
Pervious or Porous Pavement	10-20	3	1.5	1	2	7.5
Pervious Concrete						
Porous Asphalt						
Modular Concrete Block						
Extended Detention Wetland	< 10	4	2	0	1	7.0
A land area that is permanently wet with hydric soils sized to detain the WQv for a minimum of 40 hours.						
Wetland Swale	10 - 20	3	1.5	0	2	6.5
An open vegetated channel without under drains or soil matrix designed to remain wet between rain events.						
Bio-swale	10 - 20	3	1.5	0	2	6.5
An open vegetated channel with an engineered soil matrix and under drain system designed to filter runoff						
Media Filtration Practices	< 10	4	0	0	2	6.0
Surface Sand Filter						
Underground Sand Filter						
Pocket Sand Filter						
Perimeter Sand Filter						
Extended Wet Detention	10 - 20	3	2	-1	1	5.0
A basin intended to have a permanent pool and sized to detain the WQv for a minimum of 40 hours						
Vegetated Filter Strip	10 - 20	3	1	0	1	5.0
Buffer strip with native vegetation treating sheet flow						
Native Vegetation Swale	10 - 20	3	1	0	0	4.0
Native grasses and forbes planted in a swale to reduce velocity of runoff and promote infiltration						
Extended Dry Detention Basin	20 - 50	2	1	0	1	4.0
A basin line with native plant species designed to detain the WQv for a minimum of 40 hours with no permanent						
Turf Grass Swale	10 - 20	3	0	0	0	3.0
Typical turf type grasses are used in swale						
Other Systems	50 - 100 ^(b)	1	0	0	2	3.0
Proprietary Media Filtration Devices						
Hydrodynamic Devices						
Baffle Boxes						
Catch Basin Inserts						

Notes:

TSS Total suspended solids

mg/L Milligrams per liter

a Expected median event mean concentrations of TSS is based on analysis of studies in International BMP Database www.bmpdatabase.org

b Source: *Analysis of Treatment System Performance, International Stormwater Best Management Practices (BMP) Database 1999-2005*. Feb. 2006
Jurisdiction may allow higher score if independent 3rd party field data shows lower expected event mean concentrations TSS in the effluent. However if the proprietary BMP relies on sedimentation as the primary pollutant removal mechanism then performance data over the range of particle size distributions must be submitted for the range of expected flow rates.

TABLE 4.5
Value Rating Calculations

A	Water Quality Value Rating System	0	1	2	3	4+
	Median Concentration of TSS in Effluent (milligrams per liter)	> 100 mg/L	50 - 100 mg/L	20 - 50 mg/L	10 - 20 mg/L	<10 mg/L
B	Volume Reduction Rating System	0	1		2	
		Little or no volume reduction	Moderate infiltration or evaporation		Significant infiltration and evaporation	
C	Temperature Reduction Rating System	-1	0		1	
		Runoff temperature increases	Runoff temperature is unchanged		Runoff temperature decreases	
D	Oils/Floatables Reduction Rating System	0	1		2	
		Little or no oils/floatables reduction	Moderate capture or reduction of oils/floatables		Significant capture or reduction of oils/floatables	
Note: Value Rating Calculation: $VR = A + B + C + D$						

VR is calculated using the following formula:

$$VR = A+B+C+D$$

Where

- A = Water quality value
- B = Volume reduction
- C = Temperature reduction
- D = Oil and grease removal

Note that impervious cover (pavement, roof tops), turf grass lawns, and stormwater management practices that are not designed for water quality treatment such as dry detention basins are not assigned a VR. These cover types and stormwater management practices provide little to no treatment value. BMPs that are not listed in this manual or BMPs that may be custom-designed for a site will not have a VR, of course. However, innovation is not discouraged; designers and reviewers may propose “non-standard” practices based on sound designs and independent monitoring data, and evaluate them against the criteria in **Tables 4.4** and **4.5** to assign a VR on a case-by-case basis.

Calculate the area-weighted VR for the overall site using **Table 4.4** and Worksheet 2 at the end of **Section 4**. Begin by assessing the initial site development plan. Multiply the VR scores of any proposed structural BMPs by the catchment area that flows into them, or multiplying the VR for native vegetation by the area of preserved or

established native vegetation. The BMP square footage should be included in the catchment area that flows into the facility. Then sum the products and divide by the total site area to produce an area-weighted value. This step is analogous to the weighted CN that is calculated following TR-55. The resulting total is the weighted VR for the proposed stormwater management system. The weighted VR of the proposed development must meet or exceed the required LS. For example, if the required LS for the proposed development is 6, the weighted VR of the proposed stormwater management plan must meet or exceed 6.00 (rounding is not allowed).

If the proposed site plan's weighted VR will not meet the LS, create a Mitigation Package by applying BMP(s) that would receive and treat runoff from specific areas of the site. BMPs may be non-structural or structural. Calculate the Mitigation Package weighted VR based on the assigned VR for each BMP and the area of the site that the BMP would treat. If the proposed Mitigation Package does not meet the LS, test different combinations of site design and BMPs until the optimum Mitigation Package is attained.

Just changing the proposed site design (such as increasing the amount of pervious cover, preserving more native vegetation, or increasing the amount of native landscaping) may reduce the weighted CN or percent imperviousness sufficiently to lower the required LS—for example, from a 7 to a 6. LS should be recalculated for any water quality protection packages that change site cover. If a selected site design feature or BMP will decrease the proposed development's CN (for previously undeveloped sites) or percent imperviousness (for previously developed sites), recalculate the weighted CN or percent imperviousness as appropriate and recalculate the LS. Then compare the weighted VR to the revised LS. Examples 1 and 2 at the end of the section illustrate revised CN and LS calculations.

Treatment trains may be included in the Mitigation Package to improve its performance and weighted VR. As discussed in Section 3, a treatment train is two or more BMPs in series that provide cumulative water quality benefits. Although treatment train functions are not thoroughly documented, in general the effects are determined by the BMPs physical, chemical, and biological processes that function within each BMP and as flow progresses from one BMP to the next (Minton 2005). The VR (Tables 4.4 and 4.5) is designed to rank the relative effects of the processes occurring within each BMP on the four most important water quality factors. The treatment train evaluation is designed to rate the relative effects of two or more BMPs in series based on these same processes, as described below.

The interaction of the physical, chemical, and biological processes may benefit some or all of the water quality factors included in the VR and in some cases may reduce performance for a given factor and the overall VR. Just as the first BMP removes pollutants from the flow, an additional BMP placed in series may remove some of the remaining pollutants although the effectiveness diminishes with each BMP. The latest research indicates that there is an overall limit to water quality treatment for most pollutants, however (www.bmpdatabase.org; *Analysis of Treatment System Performance, International Stormwater Best Management Practices [BMP] Database 1999-2005*, February 2006). BMPs that include floatation and sedimentation processes remove oil, floatables and coarse sediments and are very effective in most cases. In most cases the final BMP in a treatment train, particularly detention practices, will have the greatest impact on the temperature reduction factor. For these reasons the effective value of the secondary practice is a function of the effectiveness of the primary practice. However, each BMP may provide detention and increase the cumulative volume reduction.

Table 4.6 provides composite VRs for the most realistic combinations of two BMPs in a treatment train. BMPs in a treatment train treat runoff from the same portion of the site. The total treatment area cannot exceed the total site area, however. When applying a treatment train in a Mitigation Package, *the VR applies to the treatment train combination*, not the individual BMPs. Example 2 at the end of Section 4 demonstrates how to apply treatment trains to weighted VR calculations. **Table 4.6** values were calculated using the following formula:

$$VR1+VR2 = (A1+A2) + (B1+B2) + C2 + (D1+D2)$$

Where

VR1 = VR for the first BMP in series

VR2 = VR for the second BMP in series

A1 through D1 = VR factors from **Table 4.4** for the first BMP in series

B2 through D2 = VR factors from **Table 4.4** for the second BMP in series

The sum of the water quality factors (A1+A2) may not exceed 4.00, or 4.25 if native vegetation is used, and the sum of the oil and floatables factor (D1+D2) may not exceed 2.00. Example 2 at the end of Section 4 includes treatment trains.

Three or more BMPs may be applied in series, although the marginal increase in VR and performance may not justify the cost. If three BMPs are applied in a treatment train, use the formula above to calculate the VR. Use the composite VR from **Table 4.6** for the first two BMPs as VR1 and the VR for the third BMP as VR2. Additional BMPs may be calculated in a similar fashion, provided that only the ultimate composite VR is applied to the site area treated by the treatment train.

Worksheets for selecting water quality protection packages are provided at the end of Section 4, along with examples.

Finally, BMPs selected to achieve the appropriate LS must be selected carefully by considering their suitability to the site's unique conditions. Consideration should be given to targeting the pollutants expected to come from the site. A BMP's ability to remove given pollutants is referenced in section 8. Before making a final selection, the designer should also consult the design guidance in Sections 7 and 8 and the "hot spot" guidance in **Appendix C** to determine whether a BMP or BMPs are feasible for the development site and to evaluate appropriate land uses, treatment suitability, physical feasibility, relative cost, and community and environmental benefits. If a BMP is not feasible or suitable for the site, evaluate additional BMPs and their corresponding design guidance to select a Mitigation Package that is feasible and meets the LS. Similarly, if the site design changes, revise the LS determination and Mitigation Package selection to meet the requirements and constraints of the new site design.

4.3 ADJUSTMENTS FOR INCREASED WATER QUALITY

Communities may require developments to meet more stringent water quality standards than the basic LS Method, which is designed to maintain predevelopment water quality. Three basic methods are described below.

One way to adjust the LS Method for improved water quality is to require developments that rate an LS of 4 or less to apply BMPs to meet the LS. In some instances meeting an LS less than 4 may require BMPs; for example, redeveloping a shopping mall with residential housing would likely reduce the sites weighted CN, but turf grass lawns do not provide treatment and would not receive a VR. In this case BMPs such as rain gardens, swales, or bioretention might be required to meet the LS.

A second way to accomplish this is to stipulate that the LS provided by the BMP package exceed the base LS by a given amount. Testing this system on both hypothetical and actual site development plans indicates that an LS increase of 0.50 or 1.00 is achievable and would increase water quality treatment significantly over the basic model. A community can adopt these thresholds (LS + 0.50 and LS + 1.00) to create a two- or three-tiered hierarchy of water quality standards based on development size or type, or other criteria appropriate to the community's water quality goals. This system could also be used to calculate and assign "water quality credits" that apply to other areas or phases of the project or to other developments.

A third way to increase water quality treatment is to require BMPs for all impervious surfaces. While such a requirement would ensure considerable water quality treatment, the LS Method would no longer function and some site design flexibility would be lost. Communities that wish to require BMPs for all impervious surfaces could allow site designers to select BMPs based on the hydrology and design criteria in Sections 6 through 8 of this manual.

Meeting a more stringent standard requiring the LS to rise may need extensive use of "treatment trains" to increase the VR of selected BMPs. Section 3 describes treatment train concepts. Section 4.2.2 provides guidance for applying treatment trains.

TABLE 4.6
Composite Value Ratings for Two BMPs in Series

Treatment Train Formula: $VR1+VR2 = (A1+A2)^* + (B1+B2) + C2 + (D1+D2)^{**}$
 * Sum of Water Quality (A1+A2) may not exceed 4.00, or 5.25 if native vegetation is used.
 ** Sum of Oil/Floatables (D1+D2) may not exceed 2.00.

Cover Type or BMP	VR 1 (First BMP in Series)										Overall Value Rating	
	9.25	9.0	8.5	7.5	7.0	6.0	6.5	6.5	5.0	5.0		
Vegetation	12.25	12.25	11.75	11.75	11.25	9.25	10.75	10.75	10.25	10.25	9.25	10.25
Rain Garden	10.50	10.50	10.00	10.00	9.50	7.50	9.00	9.00	8.50	8.50	7.50	8.50
Infiltration Practices	10.50	10.50	10.00	10.00	9.50	7.50	9.00	9.00	8.50	8.50	7.50	8.50
Bioretention	10.50	10.50	10.00	10.00	9.50	7.50	9.00	9.00	8.50	8.50	7.50	8.50
Pervious or Porous Pavement	10.50	10.50	10.00	10.00	9.50	7.50	9.00	9.00	8.50	8.50	7.50	8.50
Extended Detention Wetland	10.50	10.50	10.00	10.00	9.50	7.50	9.00	9.00	8.50	8.50	7.50	8.50
Media Filtration Practices	9.00	9.00	8.50	8.50	8.00	6.00	7.50	7.50	7.00	7.00	6.00	7.00
Wetland Swale	10.50	10.50	10.00	10.00	9.50	7.50	9.00	9.00	8.50	8.50	7.50	8.50
Bio-swale	10.50	10.50	10.00	10.00	9.50	7.50	9.00	9.00	8.50	8.50	7.50	8.50
Extended Wet Detention	10.00	10.00	9.50	9.50	9.00	7.00	8.50	8.50	8.00	8.00	7.00	8.00
Vegetated Filter Strip	10.00	10.00	9.50	9.50	9.00	7.00	8.50	8.50	8.00	8.00	7.00	8.00
Native Vegetation Swale	10.00	10.00	9.50	9.50	9.00	7.00	8.50	8.50	8.00	8.00	7.00	8.00
Turf Grass Swale	9.00	9.00	8.50	8.50	8.00	6.00	7.50	7.50	7.00	7.00	6.00	7.00
Other Systems	9.00	9.00	8.50	8.50	8.00	6.00	7.50	7.50	7.00	7.00	6.00	7.00
Extended Dry Detention Basin	10.00	10.00	10.00	10.00	8.00	6.00	7.50	7.50	8.00	8.00	7.00	8.00
VR 2 (Second BMP in Series)												
Vegetation	12.25	12.25	11.75	11.75	11.25	9.25	10.75	10.75	10.25	10.25	9.25	10.25
Rain Garden	10.50	10.50	10.00	10.00	9.50	7.50	9.00	9.00	8.50	8.50	7.50	8.50
Infiltration Practices	10.50	10.50	10.00	10.00	9.50	7.50	9.00	9.00	8.50	8.50	7.50	8.50
Bioretention	10.50	10.50	10.00	10.00	9.50	7.50	9.00	9.00	8.50	8.50	7.50	8.50
Pervious or Porous Pavement	10.50	10.50	10.00	10.00	9.50	7.50	9.00	9.00	8.50	8.50	7.50	8.50
Extended Detention Wetland	10.50	10.50	10.00	10.00	9.50	7.50	9.00	9.00	8.50	8.50	7.50	8.50
Media Filtration Practices	9.00	9.00	8.50	8.50	8.00	6.00	7.50	7.50	7.00	7.00	6.00	7.00
Wetland Swale	10.50	10.50	10.00	10.00	9.50	7.50	9.00	9.00	8.50	8.50	7.50	8.50
Bio-swale	10.50	10.50	10.00	10.00	9.50	7.50	9.00	9.00	8.50	8.50	7.50	8.50
Extended Wet Detention	10.00	10.00	9.50	9.50	9.00	7.00	8.50	8.50	8.00	8.00	7.00	8.00
Vegetated Filter Strip	10.00	10.00	9.50	9.50	9.00	7.00	8.50	8.50	8.00	8.00	7.00	8.00
Native Vegetation Swale	10.00	10.00	9.50	9.50	9.00	7.00	8.50	8.50	8.00	8.00	7.00	8.00
Turf Grass Swale	9.00	9.00	8.50	8.50	8.00	6.00	7.50	7.50	7.00	7.00	6.00	7.00
Other Systems	9.00	9.00	8.50	8.50	8.00	6.00	7.50	7.50	7.00	7.00	6.00	7.00
Extended Dry Detention Basin	10.00	10.00	10.00	10.00	8.00	6.00	7.50	7.50	8.00	8.00	7.00	8.00

Note:
 a Blank cells indicate BMP combinations that are either infeasible or highly unlikely.
 b Bold cells indicate feasible treatment train combinations that would reduce the overall VR.
 c Additional BMPs may be added using the formula above, provided that the sum of the A and D values (Table 3) do not exceed their respective maximum values, and only the C value

4.4 ADDITIONAL PRACTICES FOR STORMWATER “HOT SPOTS”

Some land uses contribute greater concentrations of hydrocarbons, metals, and other pollutants. They are called “hot spots” and may require additional measures to manage the quality of their runoff (Clayton and Schueler 1996). The final step in creating a water quality protection package is to determine whether the development is a hot spot, and, if so, to specify additional management practices or constraints on the use of some BMPs (such as avoiding infiltration practices that may contribute to groundwater pollution). **Appendix B** includes management practices for the following land uses (adapted from the City of Portland, Oregon [2002]):

- Fuel Dispensing Facilities
- Aboveground Storage of Liquid Materials
- Solid Waste Storage Areas, Containers, and Trash Compactors
- Exterior Storage of Bulk Materials
- Long-term vehicle storage areas
- Material Transfer Areas and Loading Docks
- Equipment and/or Vehicle Washing Facilities
- Covered Vehicle Parking Areas
- Kennels and Veterinary Clinics
- High-Use Vehicle and Equipment Traffic Areas, Parking, and Vehicle Storage.

WORKSHEET 1: REQUIRED LEVEL OF SERVICE - UNDEVELOPED SITE

Project:
Location:

By:
Checked:

Date:
Date:

1. Runoff Curve Number

A. Predevelopment CN

Cover Description	Soil HSG	CN from Table 1	Area (ac.)	Product of CN x Area
Totals:				

Area-Weighted CN = total product/total area = (Round to integer)

B. Postdevelopment CN

Cover Description	Soil HSG ¹	CN from Table 1	Area (ac.)	Product of CN x Area
Totals:				

¹ Postdevelopment CN is one HSG higher for all cover types except preserved vegetation, absent documentation showing how postdevelopment soil structure will be preserved.

Area-Weighted CN = total product/total area = (Round to integer)

C. Level of Service (LS) Calculation

		Change in CN	LS
Predevelopment CN:	<input type="text"/>	17+	8
		7 to 16	7
Postdevelopment CN:	<input type="text"/>	4 to 6	6
		1 to 3	5
Difference:	<input type="text"/>	0	4
		-7 to -1	3
LS Required (see scale at right):	<input type="text"/>	-8 to -17	2
		-18 to -21	1
		-22 -	0

WORKSHEET 1A: REQUIRED LEVEL OF SERVICE - DEVELOPED SITE

Project: _____ By: _____ Date: _____

Location: _____ Checked: _____ Date: _____

1. Required Treatment Area

A. Total Area Disturbed by Redevelopment Activity (ac.)

Disturbed Area Description	Acres
"1A" Total:	

B. Existing Impervious Area Inside Disturbed Area (ac.)

Existing Impervious Area Description	Acres
"1B" Total:	

C. Required Treatment Area (ac.)

"1A" Total Less "1B" Total "1C"

2. Percent Impervious in Postdevelopment Condition and Level of Service (LS)

A. Total Postdevelopment Impervious Area Inside Disturbed Area (ac.)

Postdevelopment Impervious Area Description	Acres
"2A" Total:	

B. Existing Impervious Area Inside Disturbed Area (ac.)

"1B" Total:

C. Net Increase in Impervious Area (ac.)

"2A" Total Less "1B" Total "2C"

D. Percent Impervious

Net Increase in Impervious Area / Required Treatment Area
 "2C"/"1C" x 100 (Round to Integer)

E. Level of Service

Use Percent Impervious to Enter Table XX **LS =**

3. Minimum Required Total Value Rating of BMP Package

Total Value Rating = LS x Required Treatment Area **VR =**

WORKSHEET 2: DEVELOP MITIGATION PACKAGE(S) THAT MEET THE REQUIRED LS

Project:
 Location:
 Sheet __ of __

By: _____ Date: _____
 Checked: _____ Date: _____

1. Required LS (New Development, Wksht 1) or Total VR (Redevelopment, Wksht 1A):

Note: Various BMPs may alter CN of proposed development, and LS; recalculate both if applicable.

2. Proposed BMP Option Package No. ____

Cover/BMP Description	Treatment Area	VR from Table 4.4 or 4.6 ¹	Product of VR x Area
Total²:		Total:	

*Weighted VR: = total product/total a

- ¹ VR calculated for final BMP only in Treatment Train.
- ² Total treatment area cannot exceed 100 percent of the actual site area.
- * Blank In Redevelopment

Meets required LS (Yes/No)? (If No, or if additional options are being tested, proceed below.)

3. Proposed BMP Option Package No. ____

Cover/BMP Description	Treatment Area	VR from Table 4.4 or 4.6 ¹	Product of VR x Area
Total²:		Total:	

*Weighted VR: = total product/total a

- ¹ VR calculated for final BMP only in Treatment Train.
- ² Total treatment area cannot exceed 100 percent of the actual site area.
- * Blank In Redevelopment

Meets required LS (Yes/No)? (If No, or if additional options are being tested, move to next sheet.)

WORKSHEET 1: REQUIRED LEVEL OF SERVICE - UNDEVELOPED SITE

Project: **BMP Manual Example No. 1**
 Location: Bur Oak, Missouri

By: SAS Date: 11/20/07
 Checked: Date:

1. Runoff Curve Number

A. Predevelopment CN

Cover Description	Soil HSG	CN from Table 1	Area (ac.)	Product of CN x Area
Woods/grass, good	B	55	14.00	770
Straight Row Crop	B	78	20.38	1589
Straight Row Crop	C	85	30.56	2598
Straight Row Crop	D	89	30.56	2720
Totals:			95.50	7677

Area-Weighted CN = total product/total area = 80 (Round to integer)

B. Postdevelopment CN

Cover Description	Soil HSG ¹	CN from Table 1	Area (ac.)	Product of CN x Area
Woods/grass, good	B	55	14.00	770
Streets	NA	98	19.51	1912
Residential, 1/3-acre	C	81	15.50	1255
Residential, 1/3-acre	D	86	46.49	3998
Totals:			95.50	7936

¹ Postdevelopment CN is one HSG higher for all cover types except preserved vegetation, absent documentation showing how postdevelopment soil structure will be preserved.

Area-Weighted CN = total product/total area = 83 (Round to integer)

C. Level of Service (LS) Calculation

		Change in CN	LS
Predevelopment CN:	80	17+	8
		7 to 16	7
Postdevelopment CN:	83	4 to 6	6
		1 to 3	5
Difference:	3	0	4
		-7 to -1	3
LS Required (see scale at right):	5	-8 to -17	2
		-18 to -21	1
		-22 -	0

WORKSHEET 1: REQUIRED LEVEL OF SERVICE - UNDEVELOPED SITE

(Recalculated for BMP Option Package No. 2 with more preserved native vegetation)

Project: **BMP Manual Example No. 1**

By: SAS Date: 11/20/07

Location: Bur Oak, Missouri

Checked: Date:

1. Runoff Curve Number

A. Predevelopment CN

Cover Description	Soil HSG	CN from Table 1	Area (ac.)	Product of CN x Area
Woods/grass, good	B	55	14.00	770
Straight Row Crop	B	78	20.38	1589
Straight Row Crop	C	85	30.56	2598
Straight Row Crop	D	89	30.56	2720
Totals:			95.50	7677

Area-Weighted CN = total product/total area = (Round to integer)

B. Postdevelopment CN

Cover Description	Soil HSG ¹	CN from Table 1	Area (ac.)	Product of CN x Area
Woods/grass, good	B	55	16.00	880
Streets	NA	98	19.51	1912
Residential, 1/3-acre	C	81	15.00	1215
Residential, 1/3-acre	D	86	44.99	3869
				0
Totals:			95.50	7876

¹ Postdevelopment CN is one HSG higher for all cover types except preserved vegetation, absent documentation showing how postdevelopment soil structure will be preserved.

Area-Weighted CN = total product/total area = (Round to integer)

C. Level of Service (LS) Calculation

		Change in CN	LS
Predevelopment CN:	<input type="text" value="80"/>	17+	8
		7 to 16	7
Postdevelopment CN:	<input type="text" value="82"/>	4 to 6	6
		1 to 3	5
Difference:	<input type="text" value="2"/>	0	4
		-7 to -1	3
LS Required (see scale at right):	<input type="text" value="5"/>	-8 to -17	2
		-18 to -21	1
		-22 -	0

Note: CN reduction from original plan not enough to reduce LS in this case.

WORKSHEET 2: DEVELOP MITIGATION PACKAGE(S) THAT MEET THE REQUIRED LS

Project: **BMP Manual Example No. 1**
 Location: Bur Oak, Missouri
 Sheet 1 of 2

By: SAS Date: 11/20/07
 Checked: Date:

1. **Required LS (from Table 1 or 1A or Worksheet 1 or 1A, as appropriate):** 5

Note: Various BMPs may alter CN of proposed development, and LS; recalculate both if applicable.

2. **Proposed BMP Option Package No. 1**

Cover/BMP Description	Treatment Area	VR from Table 5 or 6 ¹	Product of VR x Area	Notes:
Preserved native vegetation	14.00	9.25	129.50	(Subtract from site total)
Streets	19.51	0.00	0.00	(Subtract from site total)
Houses/driveways	15.50	0.00	0.00	(25% of remaining site)
Turf lawn	46.49	0.00	0.00	(75% of remaining site)
Total²:	95.50	Total:	129.50	
		Weighted VR:	1.36	= total product/total area

¹ VR calculated for final BMP only in Treatment Train.
² Total treatment area cannot exceed 100 percent of the actual site area.

Meets required LS (Yes/No)? NO (If No, or if additional options are being tested, proceed below.)

3. **Proposed BMP Option Package No. 2**

Cover/BMP Description	Treatment Area	VR from Table 5 or 6 ¹	Product of VR x Area	Notes:
Preserved native vegetation	16.00	9.25	148.00	[Note: 6 lots lost]
Streets with bio-swales	19.51	6.50	126.82	
Houses w/rain gardens	13.00	9.00	117.00	[Note: Maintain rain gardens through covenants or drainage easements?]
Turf lawn	22.24	0.00	0.00	
Turf lawn/driveways to bioswales	24.75	6.50	160.88	
Total²:	95.50	Total:	552.69	
		Weighted VR:	5.79	= total product/total area

¹ VR calculated for final BMP only in Treatment Train.
² Total treatment area cannot exceed 100 percent of the actual site area.

Meets required LS (Yes/No)? YES (If No, or if additional options are being tested, move to next sheet.)

*** Do not recalculate CN based on restored soils unless a single builder controls the site and guarantees proper restoration.**

WORKSHEET 2: DEVELOP MITIGATION PACKAGE(S) THAT MEET THE REQUIRED LS

Project: **BMP Manual Example No. 1**
 Location: Bur Oak, Missouri
 Sheet 2 of 2

By: SAS Date: 11/20/07
 Checked: Date:

1. **Required LS (from Table 1 or 1A or Worksheet 1 or 1A, as appropriate):** 5

Note: Various BMPs may alter CN of proposed development, and LS; recalculate both if applicable.

2. **Proposed BMP Option Package No. 3**

Cover/BMP Description	Treatment Area	VR from Table 5 or 6 ¹	Product of VR x Area
Preserved native vegetation	14.00	9.25	129.50
Streets	19.51	0.00	0.00
Houses/driveways	15.50	0.00	0.00
Native grass lawn*	46.49	9.25	430.06
Total²:	95.50	Total:	559.56
		Weighted VR:	5.86 = total product/total area

[Note: Maintain native lawns through covenants?]

- ¹ VR calculated for final BMP only in Treatment Train.
- ² Total treatment area cannot exceed 100 percent of the actual site area.

Meets required LS (Yes/No)? YES (If No, or if additional options are being tested, proceed below.)

3. **Proposed BMP Option Package No. 4**

Cover/BMP Description	Treatment Area	VR from Table 5 or 6 ¹	Product of VR x Area
Total²:		Total:	
		Weighted VR:	 = total product/total area

- ¹ VR calculated for final BMP only in Treatment Train.
- ² Total treatment area cannot exceed 100 percent of the actual site area.

Meets required LS (Yes/No)? (If No, or if additional options are being tested, move to next sheet.)

*** Do not recalculate CN based on restored soils unless a single builder controls the site and guarantees proper restoration.**



Figure 4.3 - Soils and Development summary



Figure 4.4 - Example 1 BMP Package 1

Example 1
BMP Package 2



Figure 4.5 - Example 1 BMP Package 2

Example 1
BMP Package 3

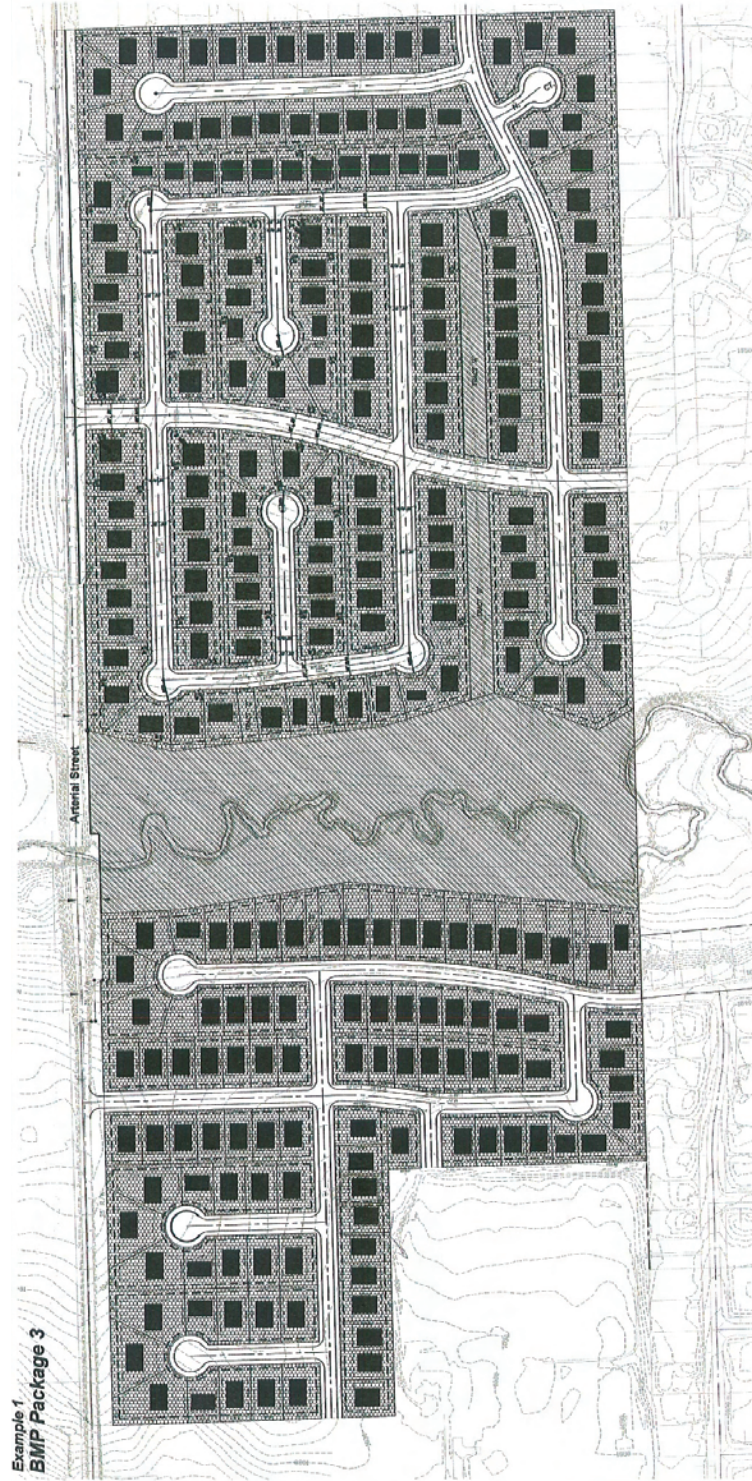

BMP Legend

- Single Entry Driveway
- Permeable Open Space
- Permeable Paved Area
- Permeable Grass Lawn

SOILS SUMMARY

Soil	Area (sq ft)	Area (sq ft)	Area (sq ft)	Area (sq ft)	Area (sq ft)	Area (sq ft)	Area (sq ft)	Area (sq ft)	Area (sq ft)
Soil 1	100	200	300	400	500	600	700	800	900
Soil 2	100	200	300	400	500	600	700	800	900
Soil 3	100	200	300	400	500	600	700	800	900
Soil 4	100	200	300	400	500	600	700	800	900
Soil 5	100	200	300	400	500	600	700	800	900
Soil 6	100	200	300	400	500	600	700	800	900
Soil 7	100	200	300	400	500	600	700	800	900
Soil 8	100	200	300	400	500	600	700	800	900
Soil 9	100	200	300	400	500	600	700	800	900
Soil 10	100	200	300	400	500	600	700	800	900

DEVELOPMENT SUMMARY:

PERM. AREA	100
IMPERM. AREA	200
TOTAL AREA	300
PERM. PERCENT	33.33%
IMPERM. PERCENT	66.67%
TOTAL PERCENT	100.00%
PERM. PERCENT	100.00%
IMPERM. PERCENT	100.00%
TOTAL PERCENT	100.00%
PERM. PERCENT	100.00%
IMPERM. PERCENT	100.00%
TOTAL PERCENT	100.00%
PERM. PERCENT	100.00%
IMPERM. PERCENT	100.00%
TOTAL PERCENT	100.00%



Figure 4.6 - Example 1 BMP Package 3

WORKSHEET 1: REQUIRED LEVEL OF SERVICE - UNDEVELOPED SITE

Project: **BMP Manual Example No. 2**
 Location: Smallville, Kansas

By: SAS Date: 11/20/07
 Checked: Date:

1. Runoff Curve Number

A. Predevelopment CN

Cover Description	Soil HSG	CN from Table 1	Area (ac.)	Product of CN x Area
Pasture, good	B	61	51.00	3111
Totals:			51.00	3111

Area-Weighted CN = total product/total area = 61 (Round to integer)

B. Postdevelopment CN

Cover Description	Soil HSG ¹	CN from Table 1	Area (ac.)	Product of CN x Area
Buildings	NA	98	10.00	980
Parking	NA	98	22.00	2156
Turf grass lawn	C	74	16.00	1184
Pond	NA	98	3.00	294
Totals:			51.00	4614

¹ Postdevelopment CN is one HSG higher for all cover types except preserved vegetation, absent documentation showing how postdevelopment soil structure will be preserved.

Area-Weighted CN = total product/total area = 90 (Round to integer)

C. Level of Service (LS) Calculation

		Change in CN	LS
Predevelopment CN:	61	17+	8
		7 to 16	7
Postdevelopment CN:	90	4 to 6	6
		1 to 3	5
Difference:	29	0	4
		-7 to -1	3
LS Required (see scale at right):	8	-8 to -17	2
		-18 to -21	1
		-22 -	0

WORKSHEET 1: REQUIRED LEVEL OF SERVICE - UNDEVELOPED SITE

(Recalculated for BMP Option Package No. 3 with native grass lawns)

Project: **BMP Manual Example No. 2**
 Location: Smallville, Kansas

By: SAS Date: 11/20/07
 Checked: Date:

1. Runoff Curve Number

A. Predevelopment CN

Cover Description	Soil HSG	CN from Table 1	Area (ac.)	Product of CN x Area
Pasture, good	B	61	51.00	3111
Totals:			51.00	3111

Area-Weighted CN = total product/total area = 61 (Round to integer)

B. Postdevelopment CN

Cover Description	Soil HSG ¹	CN from Table 1	Area (ac.)	Product of CN x Area
Buildings	NA	98	10.00	980
Parking	NA	98	22.00	2156
Native grass	B	58	16.00	928
Pond	NA	98	3.00	294
Totals:			51.00	4358

Group B only if topsoil is preserved according to Appendix A.

¹ Postdevelopment CN is one HSG higher for all cover types except preserved vegetation, absent documentation showing how postdevelopment soil structure will be preserved.

Area-Weighted CN = total product/total area = 85 (Round to integer)

C. Level of Service (LS) Calculation

		Change in CN	LS
Predevelopment CN:	61	17+	8
		7 to 16	7
Postdevelopment CN:	85	4 to 6	6
		1 to 3	5
Difference:	24	0	4
		-7 to -1	3
LS Required (see scale at right):	8	-8 to -17	2
		-18 to -21	1
		-22 -	0

Note: CN reduction from original plan not enough to reduce LS in this case.

WORKSHEET 2: DEVELOP MITIGATION PACKAGE(S) THAT MEET THE REQUIRED LS

Project: **BMP Manual Example No. 2**
 Location: Smallville, Kansas
 Sheet 1 of 2

By: SAS Date: 11/20/07
 Checked: Date:

1. Required LS (from Table 1 or 1A or Worksheet 1 or 1A, as appropriate): 8

Note: Various BMPs may alter CN of proposed development and LS; recalculate both if applicable.

2. Proposed BMP Option Package No. 1

Cover/BMP Description	Treatment Area	VR from Table 5 or 6 ¹	Product of VR x Area
Building with extended wet det.	10.00	5.00	50.00
Parking with extended wet det.	22.00	5.00	110.00
Turf lawn with extended wet det.	16.00	5.00	80.00
Extended wet detention	3.00	5.00	15.00
Total²:	51.00	Total:	255.00
		Weighted VR:	5.00 = total product/total area

¹ VR calculated for final BMP only in Treatment Train.
² Total treatment area cannot exceed 100 percent of the actual site area.

Meets required LS (Yes/No)? NO (If No, or if additional options are being tested, proceed below.)

3. Proposed BMP Option Package No. 2

Cover/BMP Description	Treatment Area	VR from Table 5 or 6 ¹	Product of VR x Area
Building with bioretention	10.00	5.00	0.00
Parking with perimeter sand filter	22.00	5.00	0.00
Turf lawn with ED wetland	16.00	7.00	112.00
ED wetland	3.00	7.00	21.00
Bioretention + ED wetland (t. train)	10.00	9.50	95.00
Sand filter + ED wetland (t. train)	22.00	8.00	176.00
Total²:	51.00	Total:	404.00
		Weighted VR:	7.92 = total product/total area

(TT = Table 6)

¹ VR calculated for final BMP only in Treatment Train.
² Total treatment area cannot exceed 100 percent of the actual site area.

Meets required LS (Yes/No)? NO (If No, or if additional options are being tested, move to next sheet.)

WORKSHEET 2: DEVELOP MITIGATION PACKAGE(S) THAT MEET THE REQUIRED LS

Project: **BMP Manual Example No. 2**
 Location: Smallville, Kansas
 Sheet 2 of 2

By: SAS Date: 11/20/07
 Checked: Date:

1. Required LS (from Table 1 or 1A or Worksheet 1 or 1A, as appropriate): 8

Note: Various BMPs may alter CN of proposed development and LS; recalculate both if applicable.

2. Proposed BMP Option Package No. 3

Cover/BMP Description	Treatment Area	VR from Table 5 or 6 ¹	Product of VR x Area
Building with ED wetland	10.00	7.00	70.00
Parking with ED wetland	22.00	7.00	154.00
Native lawn*	16.00	7.00	0.00
ED wetland	3.00	7.00	21.00
Native lawn +ED wetland (t. train)	16.00	10.25	164.00 (TT = Table 6)
Total²:	51.00	Total:	409.00
		Weighted VR:	8.02 = total product/total area

¹ VR calculated for final BMP only in Treatment Train.

² Total treatment area cannot exceed 100 percent of the actual site area.

Meets required LS (Yes/No)? YES (If No, or if additional options are being tested, proceed below.)

3. Proposed BMP Option Package No. 4

Cover/BMP Description	Treatment Area	VR from Table 5 or 6 ¹	Product of VR x Area
Building with bio-swales	10.00	7.00	0.00
Parking with bio-swales	22.00	7.00	0.00
Turf lawn with ED wetland	16.00	7.00	112.00
ED wetland	3.00	7.00	21.00
Bio-swale + ED wetland (t. train)	32.00	10.50	336.00 (TT = Table 6)
			0.00
Total²:	51.00	Total:	469.00
		Weighted VR:	9.20 = total product/total area

¹ VR calculated for final BMP only in Treatment Train.

² Total treatment area cannot exceed 100 percent of the actual site area.

Meets required LS (Yes/No)? YES (If No, or if additional options are being tested, move to next sheet.)

* Recalculated CN based on restored soils and native vegetation. See alternate Worksheet 1, attached.

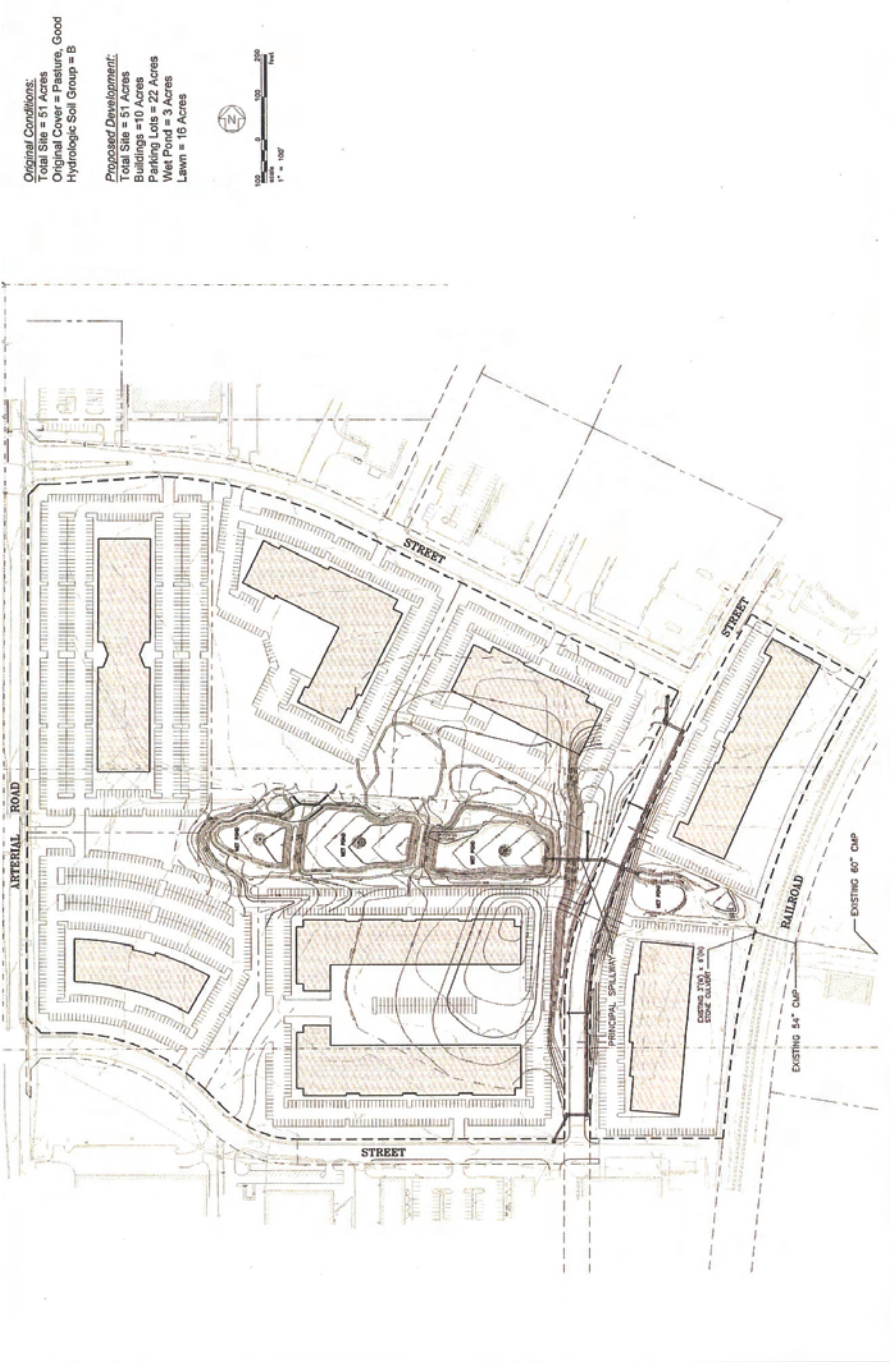

Figure 4.7 - Proposed Development



Figure 4.8 - Example 2 BMP Package 1

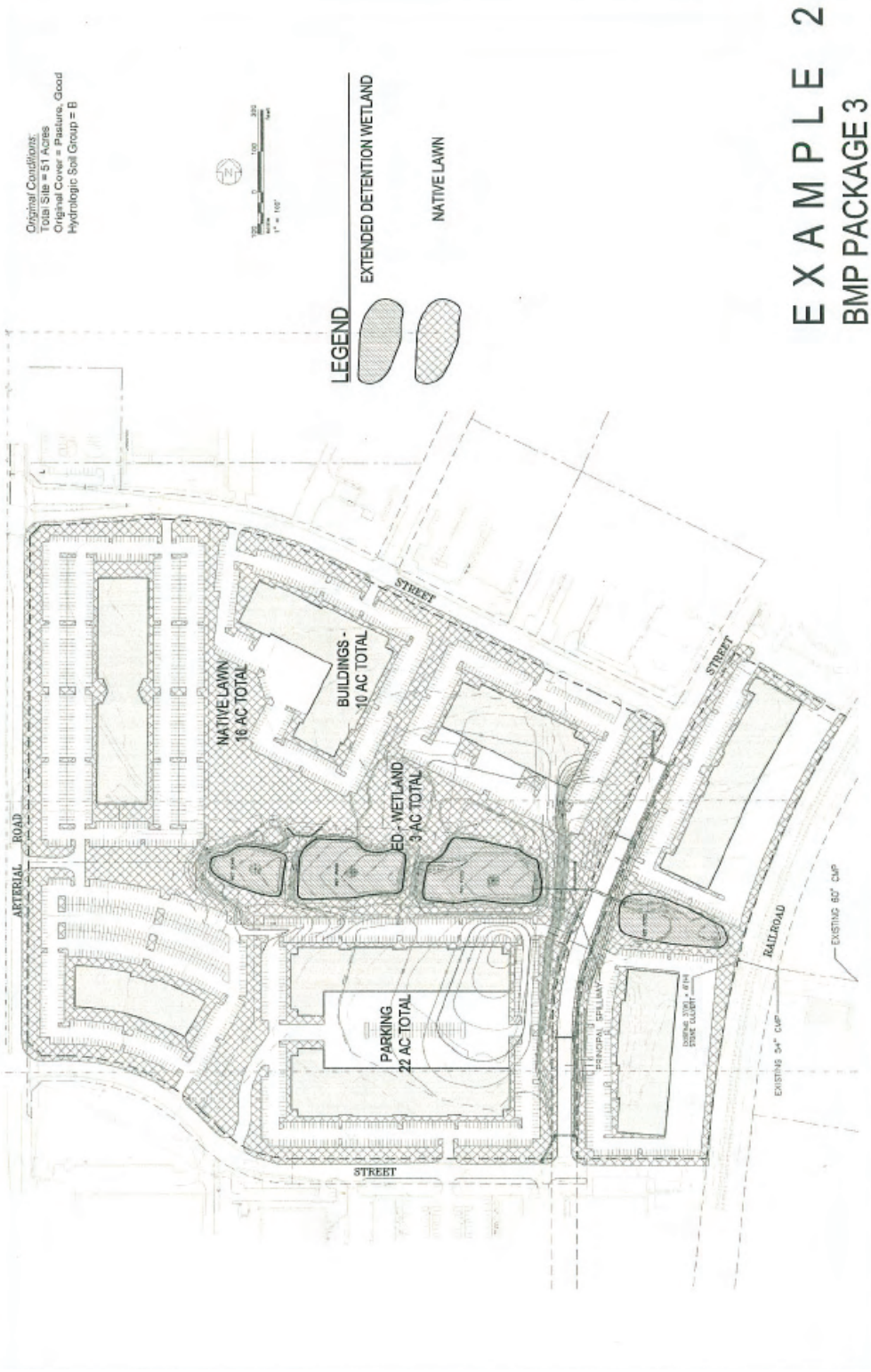

Figure 4.9 - Example 2 BMP Package 3

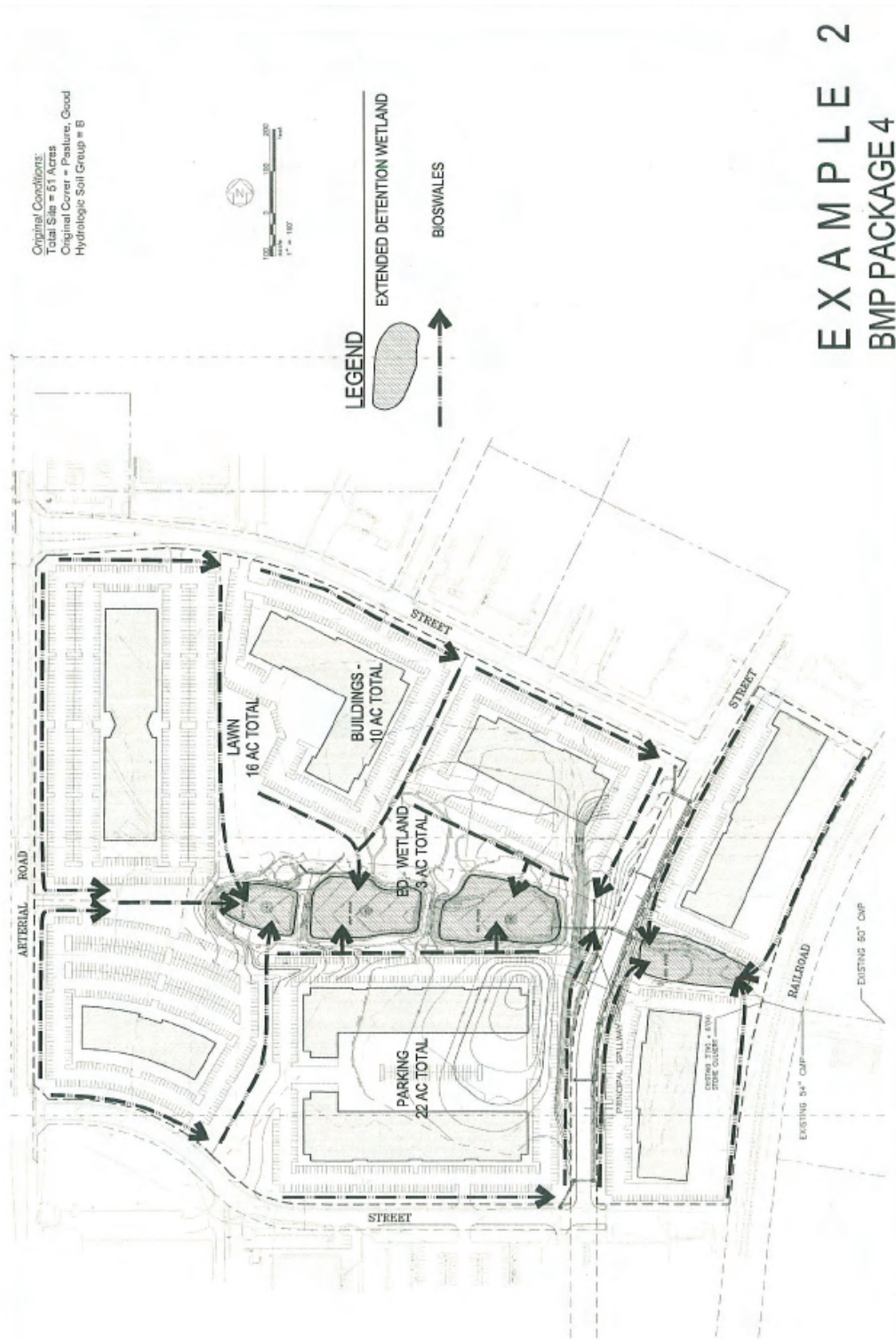

Figure 4.10 - Example 2 BMP Package 4

WORKSHEET 1A: REQUIRED LEVEL OF SERVICE - DEVELOPED SITE

Project: **BMP Manual Example No. 3** By: ABC Date: 4/1/2009
 Location: Townsville, Missouri Checked: Date:

1. Required Treatment Area

A. Total Area Disturbed by Redevelopment Activity (ac.)

Disturbed Area Description	Acres
Building (Includes border around building footprint)	0.80
Parking (Includes 10-foot border around parking area)	2.85
Access Drives (Includes 15-foot border each side of access drive)	0.59
Staging and Grading Areas	0.82
"1A" Total:	5.06

B. Existing Impervious Area Inside Disturbed Area (ac.)

Existing Impervious Area Description	Acres
Northeast building and access road	0.17
South building and access road	0.19
"1B" Total:	0.36

C. Required Treatment Area (ac.)

"1A" Total Less "1B" Total "1C" **4.70**

2. Percent Impervious in Postdevelopment Condition and Level of Service (LS)

A. Total Postdevelopment Impervious Area Inside Disturbed Area (

Postdevelopment Impervious Area Description	Acres
Building	0.43
Parking	2.02
Access Drives	0.28
"2A" Total:	2.73

B. Existing Impervious Area Inside Disturbed Area (ac.)

"1B" Total: **0.36**

C. Net Increase in Impervious Area (ac.)

"2A" Total Less "1B" Total "2C" **2.37**

D. Percent Impervious

Net Increase in Impervious Area / Required Treatment Area

"2C"/"1C" x 100 **58%** (Round to Integer)

E. Level of Service

Use Percent Impervious to Enter Table XX

LS = 5.8

3. Minimum Required Total Value Rating of BMP Package

Total Value Rating = LS x Required Treatment Area

VR = 27.26

WORKSHEET 2: DEVELOP MITIGATION PACKAGES(S) THAT MEET THE REQUIRED LS

Project: **BMP Manual Example No. 3** By: ABC Date: 4/1/2009

Location: Townsville, Missouri Checked: Date:
 Sheet: 1 of _1_

1. **Required LS (New Dev., Wksht 1) or Total VR (Redev., Wksht 1A):** 27.26
 Note: Various BMPs may alter CN of proposed development, and LS; recalculate both if applicable.

2. **Proposed BMP Option Package No. 1**

Cover/BMP Description	Treatment Area	VR from Table 4.4 or 4.6 ¹	Product of VR x Area
Building into bioretention	0.43	8.50	3.66
Access drives	0.28	0.00	0.00
Lawn	0.30	0.00	0.00
Parking/lawn into native veg. swale	2.60	4.00	10.40
Native vegetation - reestablished	1.25	9.25	11.56
Bioretention	0.20	8.50	1.70
Total²:	5.06	Total:	27.32

*Weighted VR: =total product/total area

¹ VR calculated for final BMP only in Treatment Train
² Total treatment area cannot exceed 100 percent of the actual site area
 * Blank in redevelopment

Meets required LS (Yes/No)? YES (If No, or if additional options are being tested, proceed below.)

3. **Proposed BMP Option Package No. 2**

Cover/BMP Description	Treatment Area	VR from Table 4.4 or 4.6 ¹	Product of VR x Area
Building	0.43	0.00	0.00
Access drives	0.28	0.00	0.00
Lawn	0.98	0.00	0.00
Parking into porous pavement	2.02	7.50	15.15
Native vegetation - reestablished	1.35	9.25	12.49
Total²:	5.06	Total:	27.64

*Weighted VR: =total product/total area

¹ VR calculated for final BMP only in Treatment Train
² Total treatment area cannot exceed 100 percent of the actual site area
 * Blank in redevelopment

Meets required LS (Yes/No)? YES (If No, or if additional options are being tested, move to next sheet.)

EXAMPLE 3
BMP PACKAGE 1

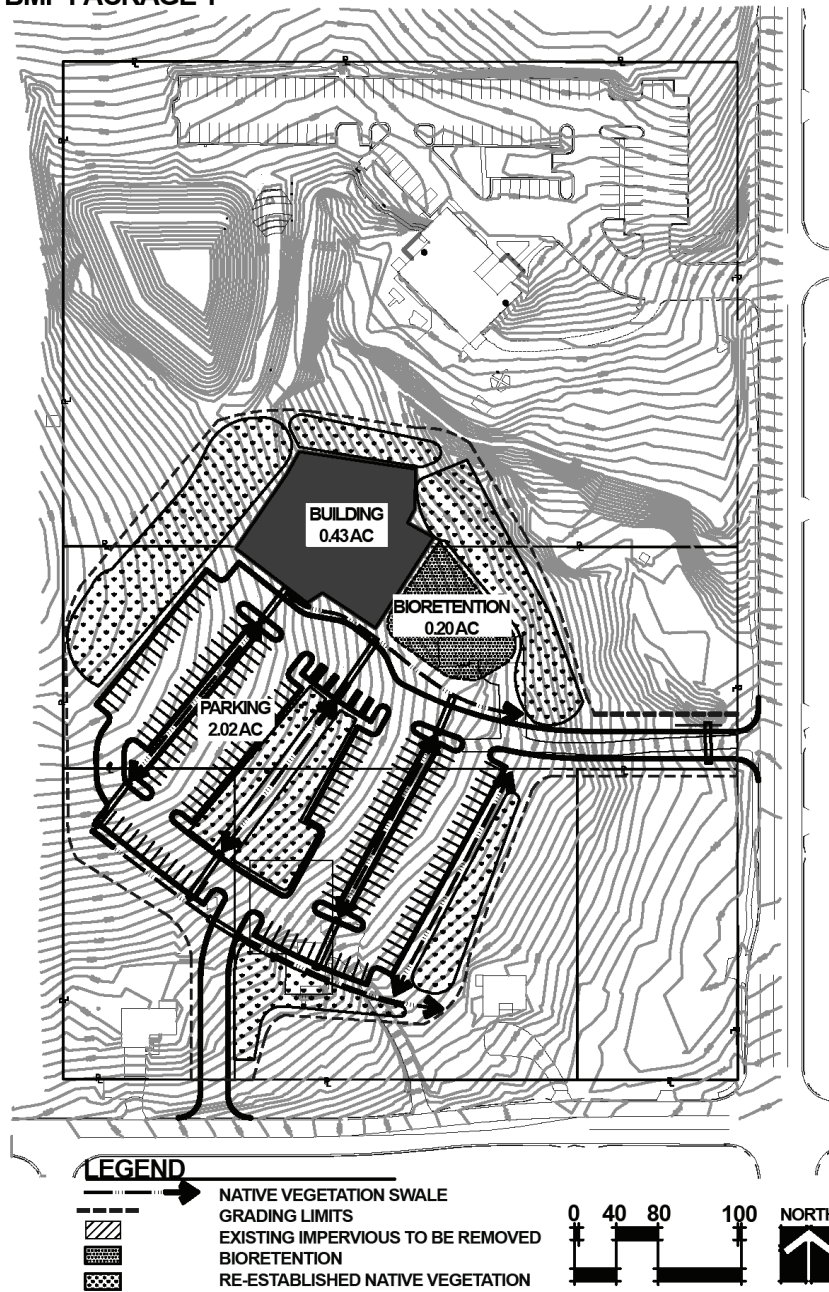

Figure 4.11 - Example 3 BMP Package 1

EXAMPLE 3

BMP PACKAGE 2

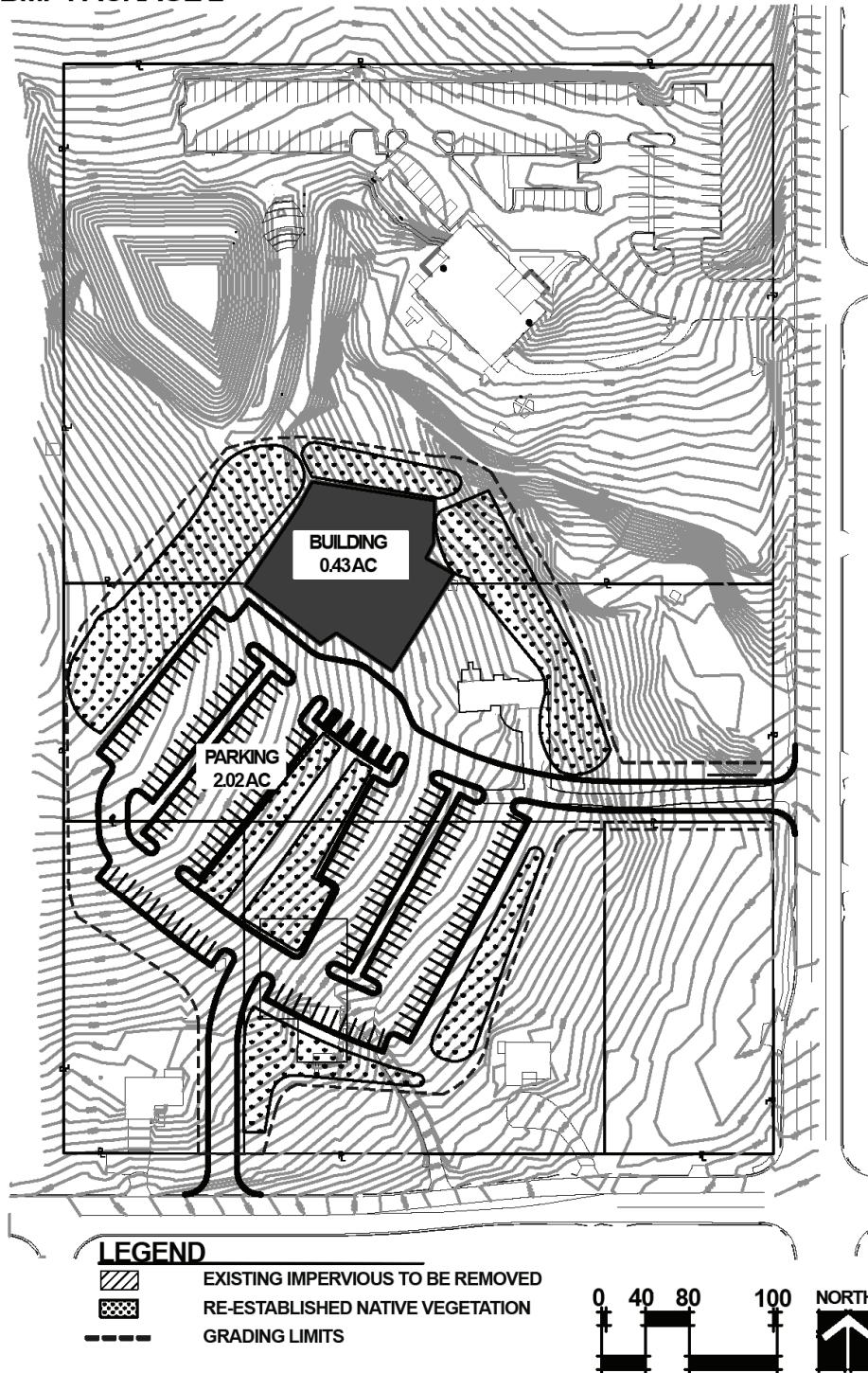

Figure 4.12 - Example 3 BMP Package 2

Section 5

Initial Measures and Minimum Practices

5.0 INITIAL MEASURES AND MINIMUM PRACTICES

The LS Method, described in Section 4.0, is detailed and flexible enough to be applicable for a wide variety of site conditions and development designs. Communities may start with a simplified water quality management program that incorporates a few widely accepted BMPs, however. The minimum program includes:

- Introducing community-wide stream buffer systems through enactment of stream setback ordinances
- Applying soil protection and restoration requirements to residential developments
- Capturing runoff from all impervious surfaces in non-residential developments using bioretention areas
- Discouraging or eliminating direct connections of impervious areas to storm drains.
- Regulating commercial and industrial “hot spots.”

Descriptions of these minimum practices follow. (General siting and design guidance are discussed in Sections 7 and 8, and detailed design specifications for each of these measures are included in Section 9. Standard specifications and plans are provided in **Appendix A.**)

5.1 STREAM BUFFERS

Creating a system of stream buffers is an important first step. The “riparian zone” (the heavily vegetated strip along the fringe of a stream) is an integral part of the stream system. For example, preservation of a 100-foot riparian buffer—only about 5 percent of the land in a typical watershed—can yield disproportionate benefits. This buffer limits development in the floodplain and controls streambank erosion; it removes pollutants from adjacent properties; and it can serve as a greenway park (Haag, Mazzeo, and Schulte 2001). Buffers also provide financial returns to communities—research indicates that a comprehensive system of stream buffers, typically about 5 percent of a community’s developable land, may increase adjacent property values by as much as 33 percent (Chesapeake Bay Foundation 1996).

A comprehensive stream setback ordinance restricts development practices and allowed uses in the stream setback zone. This broad zone encompasses a given distance and is typically divided in two to three zones. Zones closest to the stream have the most restrictions. Zones further from the stream have increased flexibility for use. Several local setback ordinances serve as models for the creation of stream setbacks and buffer zones in this region. The U.S. Environmental Protection Agency (EPA) and Johnson County, Kansas, have developed a standard ordinance that cities throughout the region may adopt (Johnson County, Kansas 2001). Stream setbacks and buffers can be based on a set of generic assumptions about streams and developments or (preferably) on actual stream conditions documented through a natural resource inventory; clear and cost-effective stream assessment protocols have been developed and used throughout the MARC region (City of Lenexa, Kansas 2001; Patti Banks Associates). Section 7 provides more information and design guidance for riparian buffer design.

5.2 SOIL PRESERVATION AND RESTORATION

The second measure to protect water quality is a development regulation requiring soil protection and/or restoration in all residential developments. Both stormwater runoff volumes and water quality are heavily influenced by infiltration capacity (USDA 1986; Claytor and Schueler 1996). Urbanization, through increased impervious surfaces and soil compaction, shorten a watershed’s response to precipitation by reducing infiltration and decreasing travel time. While impervious surfaces should be limited as much as practical, soil preservation and restoration measures can mitigate the impacts of urbanization by improving the infiltration capacity of soils in vegetated areas. Preserving the soil’s capacity to infiltrate precipitation is a relatively inexpensive non-structural measure that can be implemented as a preservation component of the site design. Soil restoration, while a potentially challenging phase of the construction sequence, is another way to improve infiltration.

Soil preservation and restoration efforts are most effective in residential developments due to limited impervious surfaces, typically 12 – 65 percent (USDA 1986). However, even in commercial, office and manufacturing areas, where impervious surfaces make up 72 – 85 percent of the area (USDA 1986), soil structure remains an important factor in producing runoff. Natural infiltration rates to underlying soils are primarily influenced by soil type, soil structure and plant cover. Any preserved area will retain these important characteristics and, thus, the pre-development infiltration capacity.

Any disturbance of a soil profile by mixing native soil profiles, introducing off-site fill materials, and increasing soil compaction can significantly change infiltration characteristics (USDA 1986). Restoring infiltration characteristics of the entire soil profile in residential areas (and other developments) after disturbance will also benefit water quality. Soil restoration requirements can help residential developments maximally infiltrate stormwater for given vegetation and cover types without structural treatment measures. Communities could include this requirement in residential development codes or as part of sediment and erosion control specifications. The requirements can be applied easily to other developments as well. A detailed soil protection and restoration specification is in Section 7.

5.3 BIORETENTION

Stormwater runoff from impervious surfaces in non-residential land uses (commercial, office, and manufacturing) should be treated. These land uses generate more impervious surface, typically 72 – 84+ percent (USDA 1986), than residential developments and, as previously described, this significantly impacts a community's water quality. Most pollutants originate from atmospheric deposition, which results in impervious surfaces being the major source of stormwater pollutants in urban areas (Claytor and Schueler 1996).

Communities can significantly impact their water quality by treating runoff from non-residential impervious surfaces, such as rooftops and parking lots. It is recommended that as part of their development code, communities require treatment of runoff from all new impervious surfaces by using bioretention cells (vegetated depressions designed to collect and treat runoff from the Water Quality Storm through an engineered matrix of soils and plant roots). Effective bioretention cells typically require only about 5 percent of the total impervious area. They are easily designed and planned as part of the site's required open space. In practice, these units are maintained in the same manner as decorative landscaped beds—minimizing maintenance costs and increasing value-added benefits. Implementing this one standardized practice in all developments can minimize design, inspection, and maintenance costs.

Detailed design guidance for bioretention is in Section 8, and standard specifications and plans are in **Appendix A**.

5.4 ELIMINATE DIRECT CONNECTIONS

Direct connections include downspouts and sump pumps that flow directly onto pavement or that are piped into stormwater inlets. By directing downspouts and sump pumps into rain gardens or other pervious surfaces, increased infiltration will result. This measure requires close attention to site drainage patterns to minimize associated problems such as building or street flooding.

5.5 REGULATE "HOT SPOTS"

Land uses that contribute greater concentrations of hydrocarbons, metals, and other pollutants are called "hot spots" and may require additional measures to manage the quality of their runoff (Claytor and Schueler 1996). Communities should require commercial and industrial hot spots to adopt industry-specific BMPs or should impose local regulations. **Appendix B** includes management practices for various land uses (adapted from the City of Portland, Oregon [2002]).

Section 6

Hydrology Methods

6.0 HYDROLOGY METHODS

6.1 GENERAL

Sizing BMPs properly is critical to their success. Design detention and retention BMPs to capture and treat the WQv. Design conveyance BMPs to handle peak discharge of the WQv. WQv is defined as the storage needed to capture and treat 90 percent of the average annual stormwater runoff volume. WQv is based on the Water Quality Storm and volumetric runoff coefficient and site area. The Water Quality Storm is defined as the storm event that produces less than or equal to 90 percent volume of all 24-hour storms on an annual basis.

The Water Quality Storm for the Kansas City Metropolitan Area is 1.37 inches (Young and McEnroe 2002).

Two methods can be used to estimate the WQv for a proposed development—the Short-Cut Method and the Small-Storm Hydrology Method.

6.2 SHORT-CUT METHOD

Use the Short-Cut Method (Claytor and Schueler 1996) only for sites with one predominant type of cover and a drainage area less than 10 acres:

$$WQv = P * Rv$$

Where:

WQv = Water Quality Volume (inches)

P = Rainfall event in inches (the Water Quality Storm of 1.37 inches or other appropriate amount, with the approval of the city engineer)

Rv = Volumetric runoff coefficient
= 0.05 + 0.009(I)

I = Percent site imperviousness (%)

6.3 SMALL STORM HYDROLOGY METHOD

The Small Storm Hydrology Method (Claytor and Schueler 1996) is based on the volumetric runoff coefficient (Rv), which accounts for specific characteristics of the pervious and impervious surfaces of the drainage catchment. This method may be used for all drainage areas. Rv's used to compute the volume of runoff are identified in **Table 6.1**. The Small Storm Hydrology Method is:

$$WQv = P * \text{Weighted } Rv$$

Where:

$$\text{Weighted } Rv = \frac{\sum(Rv_1 * Ac_1) + (Rv_2 * Ac_2) + \dots + (Rv_i * Ac_i)}{\text{Total Acreage}}$$

Rv_i = Volumetric runoff coefficient for cover type *i*

Ac_i = Area of cover type *i* (acres)

Total Acreage = Total area of the drainage area (acres)

A reduction factor may be applied to the Rv values for drainage areas with disconnected impervious surfaces. The pervious surface flow path below an impervious area must be at least twice the impervious flow path. The reduction factors are provided in **Table 6.2**.

Rainfall (inches)	Flat roofs and large unpaved parking lots	Pitched roofs and large impervious areas (large parking lots)	Small impervious areas and narrow streets	Silty soils HSG-B	Clayey soils HSG-C and D
0.75	0.82	0.97	0.66	0.11	0.20
1.00	0.84	0.97	0.70	0.11	0.21
1.25	0.86	0.98	0.74	0.13	0.22
1.37	0.87	0.98	0.75	0.14	0.23
1.50	0.88	0.99	0.77	0.15	0.24

Rainfall (inches)	Strip commercial and shopping center	Medium-to-high-density residential with paved alleys	Medium-to-high-density residential without alleys	Low-density residential
0.75	0.99	0.27	0.21	0.20
1.00	0.99	0.38	0.22	0.21
1.25	0.99	0.48	0.22	0.22
1.37	0.99	0.53	0.23	0.23
1.50	0.99	0.59	0.24	0.24

Note:
To use the reduction factors for disconnected impervious surfaces listed above, the impervious area uphill from a pervious area (a cover type that allows stormwater to infiltrate) should be less than one-half the area of the pervious surface, and the flow path through the pervious area should be at least twice the impervious surface flow path. For example, a 10-foot wide sidewalk would be a "disconnected impervious surface" if separated from the conveyance system by a 20-foot grassed strip or other pervious cover.

6.4 RATIONAL METHOD

To size a conveyance BMP correctly, calculate the peak discharge for the Water Quality Storm using the Rational Method.

The Rational Method is defined as follows:

$$Q = K \cdot C \cdot i \cdot A$$

Where:

Q = Peak rate of runoff (cfs)

C = Runoff Coefficient

$C = 0.3 + 0.6 \cdot I$ where I is percent impervious divided by 100

i = Rainfall intensity from **Table 6.3** at the calculated time of concentration (inches/hr)

K = Dimensionless coefficient to account for antecedent precipitation

$K = 1$ (Water Quality Storm which is 90% Event)

TABLE 6.3
Rainfall Intensity for Water Quality
Rainfall Event (1.37 inches)

Time of Conc. (min)	i (in/hr)
5	1.90
6	1.90
7	1.86
8	1.80
9	1.74
10	1.68
11	1.63
12	1.57
13	1.52
14	1.47
15	1.42
> 15	1.40

The rainfall rates shown in Table 6.3 pertain to the Kansas City Metropolitan area.

6.4.1 Determine Time of Concentration (T_c)

(Source: Section 5602.7 of APWA 5600, November 2005)

Time of concentration is equal to the overland flow time to the most upstream inlet or other point of entry to an enclosed system or channel plus the time for flow to travel in the enclosed system or channel to the point of consideration. The Time of Concentration (T_c) is defined as:

$$T_c = T_I + T_T$$

Where:

T_c = Time of Concentration (min)

T_I = Overland flow time to the most upstream inlet or point of entry (min)

T_T = Travel time in an enclosed or channel (min)

6.4.2 Overland Flow Time (T_I):

The overland flow time to the most upstream inlet or other point of entry shall be calculated by the following formula or other method approved by the reviewing agency but shall not be greater than 15 minutes.

$$T_I = 1.8 \cdot (1.1 - C) \cdot D^{1/2} / S^{1/3}$$

Where

T_I = Overland flow time to the most upstream inlet or point of entry (min)

C = Rational Method Runoff Coefficient

D = Overland flow distance parallel to slope (ft)

$D \leq 100$ (100 feet shall be the maximum distance for overland flow)

S = Slope of overland flow path (%)

6.4.3 Travel Time in an Enclosed System or Channel (T_T):

The time for flow to travel in an enclosed system or in channel is defined as concentrated flow and shall be calculated by the following formula or other method approved by the reviewing agency. The travel time (T_T) shall be calculated as the length of travel in the channelized system divided by the velocity of flow:

$$T_T = D_c / V$$

Where

T_T = Channelized travel time (min)

D_c = Channelized flow distance (ft)

V = Velocity of flow (ft/min)

Velocity shall be calculated by Manning's equation or from Table 6.4 when the channelized flow is in an unimproved channel.

TABLE 6.4
Unimproved Channel Velocity

Average Slope (%)	Velocity (ft/s)	Velocity (ft/min)
< 2	7	420
2 to 5	10	600
> 15	15	900

Section 7

General Guidance for Non-Structural BMPs

7.0 GENERAL GUIDANCE FOR NON-STRUCTURAL BMPS

Non-structural solutions for stormwater management include BMPs that retain or restore and conserve existing natural soil, vegetative, and hydrologic conditions to reduce stormwater runoff, filter contaminants, and improve water quality. These BMPs differ from structural BMPs in that they are not engineered specifically to collect, convey, and/or store stormwater runoff, but they can be used in conjunction with structural BMPs and are recommended for use with APWA Section 5600 or local regulations. This chapter describes non-structural BMPs and how to apply them to site design and development. Non-structural BMPs are used to conserve various types of undisturbed areas and establish native landscaping in selected environments. The non-structural BMPs described in this section also serve as the foundation for design and construction of structural BMPs as presented in Chapter 8 of this manual.

For stormwater management, one of the primary goals of site development should be minimizing site disturbance and maintaining native, natural site conditions. Impervious or paved areas should be minimized. Land that is undisturbed or restored to its natural condition will allow more water to infiltrate, reducing the amount of runoff, erosion, and potential for downstream pollution. Vegetation left in place, particularly native vegetation, slows surface runoff, filters out sediment and sediment-bound pollutants; and encourages infiltration.

As developed areas expand, regions previously undisturbed experience increased stress from invasive species, altered soil and hydrology, and other changes to the ecosystem. With increased imperviousness, peak stormwater runoff quantities also increase, moving water more rapidly away from the site. An area may actually become more a droughty or xeric environment as less water from the soil profile is available to plants. Streams experience periodic higher, more destructive flows, destabilizing their banks and eroding surrounding properties. Exotic vegetation placed on the landscape requires more chemicals and water to sustain it, requiring more expense and energy to maintain a green façade. When such development occurs, increased attention to vegetation management and on-site soil protection is essential to maintain or improve water quality. To accomplish this, a site landscaping plan should include the native flora and fauna of the local region (impacted or not) as an integral component of the site planning process.

Planting design for BMPs, both non-structural and structural, is not simply a selection of plant species likely to survive, but it is a purposeful process that identifies native plant species and understanding their complex community associations. “Native species” include vegetation indigenous to the area, that is, plant species that existed in the region (typically within a 100- to 150-mile radius) before settlement. Their traits uniquely adapt them to local conditions. Ideally, a site developer establishing or restoring native plant communities understands the relationship between plant species and their natural environment, including related plant species associations, hydrological regime, soil conditions, and available light. To achieve this goal, using an experienced landscape architect or plant ecologist to develop a successful plan is strongly advised.

Minimizing site disturbance and conserving native vegetation also benefits the developer by reducing problems associated with erosion during construction. With increased regulatory requirements for erosion and sediment control, establishing a sound vegetation conservation plan will provide key strategies for stabilizing sites during construction while also reducing costs required for expensive erosion control strategies. One successful way to minimize native vegetation disturbance is to use construction site phasing—disturbing only a portion of the site at any time. If phased site construction is not feasible, construction sites should not be left bare for a period longer than 14 days, during which the site is temporarily seeded to a cover crop. Both approaches are detailed in Chapter 10.

The following subsections describe practices that can be implemented for non-structural BMPs that will contribute significant stormwater management functions, including:

- Soil Management - Preservation
- Soil Management - Restoration
- Restoration of Native Vegetation

-
- Uplands
 - Bottomlands and Floodplains
 - Stream Buffers

7.1 SOIL MANAGEMENT - PRESERVATION

7.1.1 Description

For all development sites, soil management must be a key consideration for successful construction, including structures, successful erosion and sediment control, to final landscape design and implementation. Midwest soils tend to be high in clay, and the common misperception is that clay soils will not allow effective infiltration of water. Regional soils in their native condition are often rich in organic matter and root channels, providing rapid infiltration of water, retain a substantial water-holding capacity, and provide water for plants during longer periods of time. It is important, therefore, to conserve native soil conditions to the extent possible during development to maximize the benefits of the naturally developed soil profile.

7.1.2 General Application

While it is inevitable that soil will be disturbed during most construction activities, preservation of native soil conditions should be a component of all construction planning and processes. To retain or restore soil to a near-native condition, pre-construction soils should be evaluated and mapped. A well-conducted soil survey of a development site will include, at a minimum, a review of the county soil survey to gain knowledge of the site soil conditions, including the profile horizons, soil texture, drainage, and engineering qualities of the site. However, on-site evaluation of soil



Photo courtesy of AFS

conditions is preferred, as this information will provide the developer with knowledge of specific conditions of the site, including drainage, soil depth, soil texture, and changes in soils across the site. Understanding these characteristics can provide insight for the developer's design team to optimally place structures, place roads, drainage features, and greenspace, and plan for phasing the project.

7.1.3 Advantages

The advantage of preserving native or natural soil conditions during and after site construction activities include:

- Reduced need for grading the site to conform to a non-natural topography, reducing site development costs.
- Reduced need for erosion control measures if existing vegetation is left in place.
- Less stormwater runoff with reduced need for detention pond construction and maintenance.
- Improved conditions for post-construction landscaping applications.
- Less need for importing topsoil for landscaping applications.
- Improved long-term stormwater management factors:
 - ◇ Increased infiltration (permeability) for stormwater
 - ◇ Better rooting environment for vegetation
 - ◇ Less long-term maintenance required

7.1.4 Disadvantages

Disadvantages of native/natural soil preservation include:

- Change from current accepted methods of site development
- May require variances from existing development codes
- May require “double handling” of the soil in areas where excavation or other disturbances occur
- May increase variability in site soil conditions

7.1.5 Design Criteria

Most counties publish soil surveys prepared by the NRCS, formerly Soil Conservation Service (SCS). These surveys provide information about general soil associations and series found within each county — soil associations and series delineations on aerial photos; descriptions of soil profiles; suitability for various land uses; wildlife habitats; crops and vegetation production yields; and various engineering and chemical properties. Site development activities within areas previously disturbed by urban developments (such as site grading, road construction, and other soil disturbance activities) may require additional soil investigations to determine limits of the remaining, undisturbed, native soils types and boundaries. Where natural soil conditions will be restored, additional investigations of native soil may be needed. Qualified individuals such as professional soil scientists, practicing NRCS soil scientists, or other geoscience professionals trained in mapping soils should prepare soil surveys according to the latest soil survey methods approved by the NRCS. Generally, soils are identified through field investigations and mapping to the first or second order survey.

If it is necessary to disturb soils, the following steps provide basic guidance for re-establishing good soil quality. More detail is provided in **Appendix A**:

- Remove soil from the disturbed site carefully by horizons (e.g. ‘A’ horizon, ‘B’ horizon, etc.) and stockpile the soils from each horizon separately. If they are to be stockpiled for an extended period of time, they should be covered to minimize erosion of the soil.
- After construction, replace soil starting with soil from the lowest horizon first, grading the soil to the original contours as much as possible. The soils should be minimally compacted. The ‘A’ horizon soil, or the topsoil, should be replaced last. The ‘A’ horizon should be as near to its original depth as possible.
- Avoid excessive compaction of the soils. No fertilization is necessary if the topsoil has been replaced. The soil surface should be granular, not compacted or crusted. If the soil surface is crusted (for example, after a rain), the surface should be broken when seeding for new vegetation.
- When replacing the soil, settling must be accounted for. If the soil is roughly replaced, with little care, the soil will redistribute itself, sometimes creating undesirable contours in the landscape. If this happens, re-grading of the soil may be necessary.

7.1.6 Native Soil Restoration and Protection

Standards for native soil restoration and protection are published in two primary sources:

NRCS. 1994. NRCS Planning and Design Manual for the Control of Erosion, Sediment, and Stormwater.

Office of Surface Mining. 1983. 30 CFR Sec. 816.22. “Topsoil and Subsoil Performance Standards”. May 16.

These standards promote the following primary soil restoration and protection goals: (1) to salvage, stockpile, and restore natural soil profile(s) properly, and (2) to protect restored soils from compaction and erosion where permanent native or naturalized vegetation is to be planted and maintained. Permanent native or naturalized vegetation established on restored native soil can also benefit other BMPs such as stream buffers, engineered swales, and open space areas.

7.1.7 Maintenance

Inspect restored areas periodically to monitor plant survival and erosion problems. Protect these areas from excessive vehicular and pedestrian traffic, as well as other potential damage caused by weather events, wildlife, and humans. Replace dead trees, shrubs, and herbaceous vegetation. Periodically interplant appropriate native species; control undesirable vegetative species; and remove excessive storm debris.

7.2 SOIL MANAGEMENT - RESTORATION



Photo courtesy of AES

7.2.1 Description

Not all development sites have natural or native soil conditions, a result of previous disturbance such as farming, land forming/grading, or other urban uses. When these conditions exist, soil restoration should be considered as a component of successful site construction and stormwater management. Typically, these soils will be missing much or all of the 'A' horizon or topsoil, and often much of the upper 'B' horizon, leaving soil that has less organic matter, poorer drainage, and may not be optimal for landscaping purposes. Often, these sites have previously been graded, exposing poor, clayey subsoils with poor drainage and high stormwater runoff. It is important, therefore, to restore soil conditions to the extent possible during development to capture the benefits of a natural soil profile.

7.2.2 General Application

At sites where soils have been drastically disturbed or modified, restoration of soil quality should be a component of all construction planning and processes. It is expected that soil restoration will likely be a post construction activity. To restore optimal soil quality, the pre-construction soils should be evaluated and mapped, and a plan established that identifies locations and resources necessary for restoring soil conditions. A well-conducted soil survey of a development site will include, at the least, a review of the county soil survey to gain knowledge of the site soil conditions before the site was disturbed, or a survey of nearby soils that will include the profile horizons, soil texture, drainage, as well as engineering qualities of the site. An on-site evaluation of soil conditions is preferred, as this information will provide the developer with knowledge of specific conditions of the site, including drainage, soil depth, soil texture, and changes in soils across the site. Understanding these characteristics can provide insight for the developer's design team to optimally place structures, roads, drainage features, and greenspace.

7.2.3 Advantages

The advantage of restoring optimal soil conditions include:

- Improved conditions for post-construction landscaping applications and establishing vegetation.
- Reduced long-term vegetation management
- Improved long-term stormwater management factors:

-
- ◇ Increased permeability for stormwater infiltration and less runoff volume
 - ◇ Better rooting environment for vegetation
 - ◇ Less long-term maintenance required

7.2.4 Disadvantages

Disadvantages of soil restoration include:

- Development and implementation of soil restoration strategy: topsoil, organic matter, conditioners.
- May require “double handling” of the soil in areas where excavation or other disturbances occur
- May increase variability in site soil conditions

7.2.5 Design Criteria

To restore soil quality to good or even optimal condition, the pre-construction soils should be evaluated and mapped. A well-conducted soil survey of a development site will include an on-site evaluation of soil conditions, including drainage, soil depth, soil texture, and changes in soils across the site. Understanding these characteristics can provide insight for the developer’s design team to optimally place structures, place roads, drainage features, and greenspace, and plan for phasing the project.

Soil surveys prepared by the NRCS will provide information about general soil associations and series found within each county that can provide information about nearby soils and conditions that restoration can be targeted to. Where natural soil conditions will be restored, additional investigations of native soil may be needed. Qualified individuals such as professional soil scientists, practicing NRCS soil scientists, or other geoscience professionals trained in mapping soils should prepare soil surveys according to the latest soil survey methods approved by the NRCS. Generally, soils are identified through field investigations and mapping to the first or second order survey.

Even on disturbed soils, the following steps provide basic guidance for re-establishing good soil quality.

- Remove good quality soil from the disturbed site carefully by horizons (e.g. ‘A’ horizon, ‘B’ horizon, etc.) and stockpile the soils from each horizon separately. If they are to be stockpiled for an extended period of time, they should be covered to minimize erosion of the soil.
- After construction, replace soil starting with soil from the lowest horizon first, grading the soil to the original contours as much as possible. The soils should be minimally compacted. The ‘A’ horizon soil, or the topsoil, should be replaced last. The ‘A’ horizon should be as near to its original depth as possible.
- During final grading of soils, avoid excessive compaction of the soils. Use farm or soil preparation implements to break compacted or hardened soils. Where necessary, mix soil conditioners (organic matter such as compost, or chemical additions) into the soil. If possible, place and grade good quality topsoil (at least four inches) as the surface soil before planting vegetation. No fertilization is necessary if the topsoil has been replaced. The soil surface should be granular, not compacted or crusted. If the soil surface is crusted (for example, after a rain), the surface should be broken when seeding of new vegetation occurs.
- When replacing the soil, settling must be accounted for. If the soil is roughly replaced, with little care, the soil will redistribute itself, sometimes creating undesirable contours in the landscape. If this happens, re-grading of the soil may be necessary.

7.2.6 Native Soil Restoration and Protection

Standards for native soil restoration and protection are published in two primary sources:

NRCS. 1994. NRCS Planning and Design Manual for the Control of Erosion, Sediment, and Stormwater.

Office of Surface Mining. 1983. 30 CFR Sec. 816.22. “Topsoil and Subsoil Performance Standards”. May 16.

These standards promote the following primary soil restoration and protection goals: (1) to salvage, stockpile, and restore natural soil profile(s) properly, and (2) to protect restored soils from compaction and erosion where permanent native or naturalized vegetation is to be planted and maintained. Permanent native or naturalized vegetation established on restored native soil can also benefit other BMPs such as stream buffers, engineered swales, and open space areas.

7.2.7 Maintenance

Inspect restored areas periodically to monitor plant survival and erosion problems. Protect these areas from excessive vehicular and pedestrian traffic, as well as other potential damage caused by weather events, wildlife, and humans. Replace dead trees, shrubs, and herbaceous vegetation. Periodically interplant appropriate native species; control undesirable vegetative species; and remove excessive storm debris.

7.3 RESTORATION OF NATIVE VEGETATION

Vegetation management is critical to the success of stormwater BMPs, particularly native vegetation. All native vegetation, when it is newly-planted, requires care and maintenance. Native landscapes – those that are planted to native vegetation – provide the advantages of plants that are adapted to the area or region within which the BMPs are to be used. Native landscapes by themselves are effective stormwater BMPs that don't require engineering design and require less maintenance over time. This section provides general guidance for establishment of native vegetation for site restoration, including designed landscape features, as well as establishing native vegetation for both non-



Photo courtesy of AES

structural and structural BMPs. Section 8.0 provides general guidance for structural BMPs such as bioretention basins, vegetated swales, rain gardens, and other BMPs. Underlying the success of any of these BMPs is the successful establishment and maintenance of native vegetation.

7.3.1 General Application

Native vegetation reduces stormwater runoff by intercepting rainfall in its canopy, reducing surfacewater velocity across the ground surface, and by increasing the infiltration capacity of the soil by extending deep roots and facility soil microbial interactions that create permeable soil structure – even in clays. Native vegetation should be conserved where possible in urban as well as suburban and rural areas to facilitate improved stormwater management. It is a primary component of the natural landscape as well as for structural BMPs.

7.3.2 Advantages

Native vegetation provides the following advantages:

- Because it is indigenous to the area, it will be able to thrive in the local climate with less maintenance.
- Deep roots enhance stormwater infiltration into the soil.
- With deep-rooted nature, native vegetation is able to withstand flooding events as well as extended dry periods.
- Reduces flow velocity of stormwater runoff.

- Can be used in total landscape design in restoration of native prairie, woodland, wetlands, and riparian areas, or as landscape features.
- Attracts wildlife and improves biological diversity.
- Requires little to no fertilizer or chemical maintenance, as well as reduced amounts of water to survive.
- Provides attractive and natural vegetative scenery.

7.3.3 Disadvantages

- Native vegetation can be difficult to establish if some circumstances.
- Native vegetation can be expensive if planted from nursery stock plugs.
- Considered “weedy” by some people.

7.3.4 Design Considerations

For use of native vegetation for stormwater BMPs, both non-structural and structural, consider the location of BMP (for example, parking lot, street scape, or yard) and the types of vegetation most appropriate for that location. Consider effective height of vegetation and general appearance of landscaping features. Select vegetation considering slope, aspect, drought, and water tolerance; and (if relevant) salt tolerance. When appropriate, mix small trees, shrubs, grasses, sedges, and forbs to achieve maximum diversity.

If native restoration and landscaping is to be achieved (prairie, woodland, wetland, or riparian areas), consult a restoration ecologist about the native environment that existed in the area and the localized conditions that will support the native vegetation restoration. Soils and hydrology should be considered and evaluated, and the extent of the restoration (small area vs. several acres) to determine the vegetation composition and diversity.

Restoration planning of native vegetation for non-structural and structural BMPs includes mechanical and chemical removal of exotic invasive species, reduction of other undesirable trees and brush, re-introduction of fire, removal of dams or breaking of tiles, removal of debris within the restoration site, treatment of erosion and contamination problems, and manual or mechanical installation of native seeds and plants, including larger shrubs and trees.

7.3.5 Planting Densities

Complement natural features within and adjacent to the site with suitable location, layout, and appearance of the BMP to be constructed. As a general rule of thumb, use the following densities for trees and shrubs:

TABLE 7.1
Planting Densities for Stormwater BMPs

Plant Types/Heights	Plant Spacing
Small Shrubs (<10 feet)	3 to 6 feet
Large Shrubs / Small Trees (10 to 25 feet)	6 to 8 feet
Large Trees	8 to 16 feet
Wetland and Aquatic Species (1 to 3 feet)	1 to 2 feet

Consider depths of detention and permanent water pools when selecting vegetation for wetland or frequently inundated areas. Avoid shrubs that block the view of other vital aspects. Do not introduce tree species with low hanging branches if a trail is nearby.

Recommendations for plant materials for most non-structural and structural BMPs is provided in **Appendix A**, Section 2.

7.3.6 Maintenance

Native vegetation used in stormwater BMPs does require maintenance, but not as frequently as traditional, exotic landscaping. Natural community responses to restoration treatments, however, can be dynamic and unpredictable. For this reason, native landscape management and maintenance strategies need to be flexible and allowed to change over time to respond to natural communities as they adjust to restoration intervention treatments. Careful monitoring and evaluation of community responses are critical steps in an adaptive management process. This allows for measured changes in the timing and application of specific treatments to better improve the overall performance of the site.

For these reasons, a vegetation management plan should be developed that allows adaptive management, not absolute prescriptive management. The plan is a starting point in an ongoing process that relies on monitoring to provide feedback on program effectiveness and for evaluation of the need and justification for changes in the management plan. This process of evaluation, adjustment, refinement and change is adaptive management, and it is fundamental to the effective restoration and management of natural communities. Adaptable management and maintenance plans are fundamental to the health, longevity, and ultimate success of the restored native landscapes.

Maintenance tasks may include periodic use of chemical and mechanical removal of invasive species, and modest enhancement seeding and planting. While this phase of the program can be viewed as a routine maintenance program conducted annually at strategic times to achieve and maintain specific ecological and biological objectives, management decisions must remain responsive to the guiding principle of adaptive management.

General, on-going tasks include inspection of both non-structural and structural BMPs periodically to monitor plant survival. BMPs need to be protected from excessive pedestrian traffic; pest infestations; and other potential damage caused by storm events, wildlife and humans.

Specialized training for restoration and management tasks of any vegetation is often necessary. For many of the restoration tasks (i.e. prescribed burning, herbicide use, and monitoring) specialized training, often licensing or certification, and oversight and guidance are required well in advance of the dates for commencement of the restoration program. Personnel and volunteers involved in prescribed burning, brush control, monitoring, seed collection, etc., should receive training commensurate with the activity in which they would be involved. Training is especially important for those activities that may have risk and safety implications (i.e. prescribed burning), but also for monitoring, where an accurate assessment of the ecological performance of the ecological system to the restoration treatments is required.

7.4 UPLANDS

“Uplands” are those areas that are typically elevated above bottomlands and floodplains, retaining well-drained hydrologic conditions. Prairie grasses and a few tree species typically dominate undisturbed and native landscaped uplands. Numerous prairie grasses are native to the eastern Kansas and western Missouri region, including (but not limited to), big bluestem, little bluestem, indian grass, switchgrass, prairie dropseed, western wheatgrass, and Canada wild rye. Upland tree species include, but are not limited to, hickory, oak, hackberry, and black locust, among others.



Photo courtesy of AES

7.4.1 General Applications

Upland areas provide the first and primary point of stormwater management. It is in these uplands that rainfall will infiltrate into the soil and provide subsurface drainage, recharging groundwater conditions and maintaining perennial stream flow. Native vegetation intercepts and catches rainfall, reducing the amount that hits the ground, allowing evaporation of a significant portion of precipitation. The rainfall that reaches the ground infiltrates into the soil where it is held for plant use, or may slowly seep to stream systems. This process reduces the amount and velocity of water moving into lower areas, minimizing flooding conditions and protecting properties. Upland vegetation filters sediment and other pollutants from stormwater runoff while also providing wildlife habitat and aesthetic values for the public.

7.4.2 Advantages

- Preserves predevelopment hydrology effectively—especially streams, ponds and lakes
- Slows surface flows, promotes infiltration, and reduces erosion
- Traps sediment and sediment-bound pollutants
- Improves soil structure
- Typically requires less maintenance than non-native landscaping
- Preserves wildlife habitat and provides aesthetic and recreational benefits
- Requires significantly less maintenance expense

7.4.3 Disadvantages

- Reduces the area of land available for development
- Limits construction to locations around open space
- May require a cover crop
- Cannot be established during winter.

7.4.4 Design Criteria

To establish native uplands, choose plant species suited to the location. Consider moisture regimes, soils, light levels, runoff properties (pollutants, concentrated flow, and sheet flow), intended land use, and level of maintenance. Determine seeding rates considering the intended purpose of the site. Decide how to apply the seed (for example, broadcasting, drilling, or hydroseeding). Determine correct fertilization rates, if required, by soil testing. Submit soil samples to a qualified laboratory or to the local county extension service for nutrient testing. Seedbed preparation is critical to success of plantings—so do not over compact the soil.

7.4.5 Maintenance

Conserving existing upland native vegetation demands less maintenance than turf grass plantings or other landscaping, reducing operations and maintenance costs. Minimal mowing and herbicide application is needed to maintain a healthy stand of native vegetation. Some mechanical means may be necessary to control invasive species and preserve the health of the system. Minimal to no fertilization is required. Establishing native uplands necessitates that seeded areas be kept moist during the first weeks of establishment; mulch is also recommended. Reseeding may be necessary when the first seeding does not produce a vigorous stand.

Mowing is only occasionally necessary, and fertilizers are not required to maintain a healthy stand of native vegetation. If controlled burning is not an option, mowing can control unwanted deciduous growth that may encroach on prairie plantings.

7.5 BOTTOMLANDS AND FLOODPLAINS



Photo courtesy of AES

Bottomlands are defined as low-lying lands along a watercourse that floods frequently. The floodplain is a level surface of stratified alluvial soils on either side of a watercourse; it is typically built up by silt and sand, carried out of the main channel, and submerged during times of flood. Undisturbed bottomlands and floodplains typically host a diverse assemblage of plant species.

Preserving bottomland and floodplain vegetation during development maintains a natural buffer that can filter out sediment from runoff before it enters the watercourse; and reduce the velocity of surface water runoff, thus decreasing the potential for erosion.

Typically, soils near a watercourse in the floodplain have high water tables and low bearing strength. Along with the prospect of frequent flooding, this limits construction feasibility and encourages preservation of bottomlands and floodplains. The habitat of bottomlands and floodplains often provides a desirable environment for aquatic and terrestrial wildlife, giving the public an opportunity for recreations such as fishing or observing wildlife.

7.5.1 Advantages

- Most effectively preserve predevelopment hydrology
- Slow surface flows, which promotes infiltration and reduces erosion
- Trap sediment and sediment-bound pollutants
- Improve soil structure
- Host microorganisms and plants that transform nutrients into usable forms and can break down pollutants
- Preserve wildlife habitat and provide aesthetic and recreational benefits.

7.5.2 Disadvantages

- Reduce amount of developable land
- Limit construction to locations around open space.

7.5.3 Design Criteria

To establish floodplain and bottomland vegetation:

- Choose plant species suited to the location.
- Consider moisture regimes, soils, light levels, runoff properties (pollutants, concentrated flow, and sheet flow), intended land use, and level of maintenance.
- Determine seeding rates considering the intended purpose of the site. Decide how to apply the seed (for example, broadcasting, drilling, or hydroseeding).
- Submit soil samples to a qualified laboratory or to the local county extension service for nutrient testing. Seedbed preparation is critical to success of plantings—so do not over compact the soil.

7.5.4 Maintenance

Once established, native vegetation in floodplains requires little maintenance. Depending on the desired use of the floodplain, general maintenance may require replacement of dead or undesirable trees and shrubs to prevent overpopulation of undesirable species; selectively harvesting trees and shrubs to reduce overgrowth, and control of invasive species. Mechanical means or prescribed burning may be necessary to manage the area.

For wetlands, ponds or frequently inundated areas, inspect the areas periodically to monitor plant survival. Protect it from excessive sedimentation; pest infestations; and other potential damage caused by storm events, wildlife, and humans. Replace dead trees, shrubs, and herbaceous vegetation. Periodically control undesirable vegetative competition. Remove excessive buildup of sediment, storm debris, and trash.

7.6 STREAM BUFFERS

Stream buffers are important BMPs to be included when determining the proper package of BMPs (as directed in Section 4). They are defined as strips of heavy herbaceous and woody vegetation along streams (perennial and intermittent) and open bodies of water. They help reduce the impact of runoff by trapping sediment and sediment-bound pollutants, encouraging infiltration, and slowing and dispersing stormwater flows over a wide area. They help preserve streambank stability by reinforcing the soil with root systems. In addition, they provide detritus and biomass for aquatic and terrestrial habitat, shade cover to manage stream temperatures, and wildlife corridors (USDA 1999).



Photo courtesy of AES

APWA Section 5605.3 specifies stream buffers for all drainage areas greater than 40 acres, and recommends that cities adopt comprehensive stream preservation and buffer zone requirements as part of their master plan. Stream buffer creation and maintenance also may be required and enforced by development codes and city ordinance.

7.6.1 Advantages

- Most effectively preserve predevelopment hydrology—especially streams, ponds, and lakes
- Slow surface flows, which promotes infiltration and reduces erosion
- Trap sediment and sediment-bound pollutants
- Improve soil structure
- Transform nutrients into usable forms and break down pollutants via actions of microorganisms and plants
- Preserve wildlife habitat and provide aesthetic and recreational benefits
- May lower water temperature
- Provide floodplain protection from erosion.

7.6.2 Disadvantages

- Reduce amount of developable land
- Limit construction to locations around open spaces
- May require a cover crop in zone 3

7.6.3 Design Criteria

APWA Section 5605.3 does not specify multiple zones. From a design perspective, stream buffers consist of minimally two zones; however, they are more effective if they have three zones. Zone 1 typically extends from the water's edge or top of bank for a set distance to protect the immediate streamside area, and is planted with fast

growing tree and shrub species suited for the site. Riparian grasses and wildflowers are also recommended to help stabilize soils and add diversity to the area. Activities and structures are most restricted in this zone. Zone 2 extends from the edge of Zone 1 and includes slower growing tree species and shrubs as well as native grasses and forbs. The width of Zone 2 may be set or variable. No permanent structures are permitted in this zone, but more intensive activities may be permitted, such as hiking and biking trails. Where appropriate, Zone 3 is upgradient of Zone 2 and provides a buffer to protect Zones 1 and 2. This zone may include more intensive activities such as residential landscaping, but no permanent structures. Design criteria from NRCS and Johnson County, Kansas are provided below. **Table 7.2** shows recommended vegetation for stream buffers.

According to Section 5605.3, buffer widths as measured from the ordinary high water mark (OHM) outward in each direction shall exceed the following:

TABLE 7.2
Stream Buffer Widths

Contributing Drainage Area	Buffer Width, from OHM Outwards
Less than 40 acres	40 feet
40 to 160 acres	60 feet
160 to 5,000 acres	100 feet
Greater than 5,000 acres	120 feet

Design criteria should be adapted to incorporate these minimum widths. According to NRCS design standards for Kansas, Zone 1 shall begin at the waterline or top of bank and extend for a minimum of 15 feet. Where an active floodplain is connected to the water body, the combined widths of Zones 1 and 2 should be the smaller of 30 percent of the floodplain or 100 feet. Runoff entering Zone 3 of the buffer must be sheet flow. A flow spreader may be required to ensure that concentrated flows do not occur. The width of Zone 3 must be 33 percent of the contributing area length with a minimum of 30 feet and maximum of 120 feet. Zone 3 vegetation should include permanent, native herbaceous vegetation consisting of grasses, sedges, and forbs. The NRCS specifies a minimum buffer width of 35 feet; however, the minimum width should be increased in keeping with Section 5600. When establishing a stream buffer, select appropriate methods of planting and seeding (USDA, 1999; see **Appendix A**). **Figure 7.1** provides a representative stream buffer zone schematic.

7.6.4 Maintenance

Once established, native vegetation in stream buffers requires little maintenance. General maintenance may require replacement of dead or undesirable trees and shrubs to prevent overpopulation of undesirable species; selectively harvesting trees and shrubs to reduce overgrowth, and control of invasive species. Mechanical means or prescribed burning may be necessary to manage the area.

For frequently inundated areas, inspect the stream buffer periodically to monitor plant survival. Protect it from excessive sedimentation, pest infestations, and other potential damage caused by storm events, wildlife, and humans. Replace dead trees, shrubs, and herbaceous vegetation. Periodically control undesirable vegetative competition. Remove excessive buildup of sediment, storm debris, and trash.

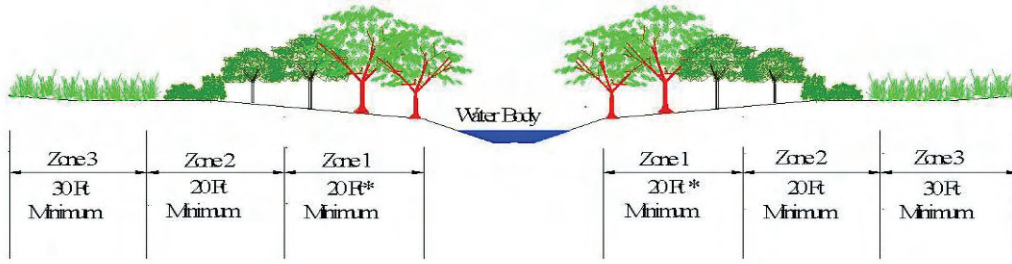

Source: USDA 1999;

* modified in accordance with APWA Section 5605.3

Figure 7.1 - Stream Buffer Zone Placement Example

Section 8

General Guidance for Structural BMPs: Engineered Systems

8.0 GENERAL GUIDANCE FOR STRUCTURAL BMPs: ENGINEERED SYSTEMS

If minimizing site disturbance and introducing native landscaping practices are not feasible during site development, select engineering practices to promote infiltration, water storage and water treatment. Structural BMPs differ from nonstructural practices in that they are engineered to manage stormwater for water quality treatment. Many structural BMPs ally native vegetation with man-made materials and engineered subgrades to help control runoff

As described in section 5, structural BMPs may promote some combination of infiltration, filtration, detention, and water quality treatment. BMPs that promote infiltration include, but are not limited to; bioretention, pervious pavement, rain gardens, and sand filters. Structural BMPs that provide on-site filtration include bioretention, swales, and sand filters. On-site stormwater detention is storage of excess runoff before its entry into principal drainage system. Extended wet and dry detention and extended detention wetlands are examples of detention practices. Incorporate them into the site design to preserve native landscaping when infiltration practices are not possible. Finally, manufactured devices such as inlet inserts, baffle boxes and hydrodynamic separators provide water quality treatment without providing any storage.

The design guidelines in this section provide detailed descriptions of each type of BMP as well as guidance for its use and a detailed design example of each.

8.1 RAIN GARDENS



Targeted Constituents

Sediment	●
Nutrients	◐
Trash	●
Metals	●
Bacteria	●
Oil and Grease	●
Organics	●

Legend (Removal Effectiveness)

High	Medium	Low
●	◐	○

8.1.1 Description

A rain garden is an infiltration device consisting of a small excavated area that is covered with a mulch layer and planted with a diversity of woody and herbaceous vegetation. Storm water directed to the device percolates through the mulch and into the native soil, where it is treated by a variety of physical, chemical and biological processes.¹ Generally, a rain garden is a small depression planted with native wetland and prairie vegetation (rather than a turfgrass lawn) where stormwater runoff collects and infiltrates. Runoff can be from sheetflow or from direct discharge from rain spouts, swales, or directed drainage from impervious areas on a property. Rain gardens function similar to larger-scale bioretention areas, providing collection and infiltration of rainwater, reducing runoff into the common stormwater system. Rain gardens can provide effective contributions to stormwater runoff reduction if they are sufficient in number and common throughout an area. Individual gardens also aid in controlling the volume of runoff

from individual lots that would otherwise combine with and contribute to runoff from other properties into the stormwater sewer system.

8.1.2 General Application

Rain gardens can be used to enhance stormwater runoff quality and reduce peak stormwater runoff rates from small sites. Rain gardens can be used to improve the quality of urban/suburban runoff coming from roof tops, driveways, and lawns of residential neighborhoods, small commercial areas, and parks. They are typically most effective for catchments less than one acre. They can be used as an onsite BMP that works well with other BMPs, such as upstream onsite source controls and downstream infiltration/filtration basins.

8.1.3 Advantages/Disadvantages

8.1.3.1 General

Rain gardens are promoted and designed as native landscapes that add to aesthetic appearances of properties while reducing peak runoff rates and improving water quality. In residential application, they are intended to provide the enjoyment of gardening and observing native plants and wildlife as well as serving an important drainage and stormwater function for the homeowner. They are effective in removing particulate matter and the associated heavy metals and other pollutants. As with other BMPs, safety issues need to be addressed through proper design.

8.1.3.2 Physical Site Suitability

Normally, the area required for rain garden may be from 10 to 40 percent of it's catchment area, depending on the amount of impervious area, soil conditions, and types of plants used. Site specific soil testing to check infiltration is appropriate to determine the design requirements of the rain garden. If infiltration rates are less than 0.10 inch per hour² (typical of a clay loam soil), the soil is not suitable for a rain garden, or the site may need an engineered soil mix to promote infiltration. Rain gardens using an engineered soil mix should use a 1:1 sand/compost mix to a depth of approximately two feet if the soil is deep enough. Rain gardens should be placed near the end of a runoff area before stormwater leaves the site, or in a low area of the property where water collects. Factors limiting the effectiveness of rain gardens include slope, depth and type of soil, and available area for the rain garden.

8.1.3.3 Pollutant Removal

Raingardens are effective in removing from 30 to 90 percent of nutrients (such as nitrogen and phosphorus) and 80 percent of sediments as well as reducing runoff volumes. Removal of suspended nutrients, solids, and metals can be moderate to high.

A major factor controlling the degree of pollutant removal is the volume and rate of stormwater runoff captured by the rain garden that filters through the vegetation and infiltrates into the soil. The rate and degree of removal may depend on the amount of time that the garden remains saturated, with varying degrees of nitrate and phosphorus removal depending on the buildup of organic materials in the raingarden, and plant uptake. Metals, oil and grease, and some nutrients have a close affinity for suspended sediment and will be removed partially through sedimentation.

8.1.3.4 Aesthetics and Multiple Uses

Rain gardens should be designed to drain within 24- to 48-hours. It's not unusual, however, for rain gardens to be inundated frequently. Vegetation planted in parts of the rain garden that are frequently inundated should be species that can survive both frequently wet or often dry conditions. In this respect, native wetland or mesic wetland species can be planted that facilitate both excellent drainage as well as aesthetic qualities.

Because rain gardens are intended to be aesthetically pleasing components of residential or small commercial properties, proper selection and placement of native species that are attractive and acceptable to land owners is important. Native species that are deep-rooted perennials are used to achieve the desired function of stormwater

runoff capture and infiltration. Species selection for the rain garden should consider the drier portions of the garden (elevated berms to catch runoff) as well as the lower, wetter areas of the garden.

8.1.4 Design Considerations

Rain gardens can be designed to function individually or as part of a larger stormwater treatment system. Also, whenever possible, consider the recreational and aesthetic factors of gardening, and the wildlife function that can be served in a rain garden, even in urban areas. Main design components should include:

- The ponding depth of a rain garden is typically 4 to 6 inches. Some rain gardens, however, have deeper ponding depths that drain completely within two days.
- Limit ponding in the depressional area to 2 days or less to avoid nuisance insects.
- Clay soil will typically require amendments such as compost or peat to enhance porosity and more rapid root growth, and to improve infiltration during the first year. To provide better infiltration during the first year, a 1:1 sand/compost mix may be used in the raingarden.
- A layer of rich organic material and/or mulch should be placed over the soil in the depressional area. The organic material and/or mulch holds moisture and aids removal of metals.
- Rain gardens should be placed a minimum of 10 feet away from building foundations.
- Placement of the rain garden and overflow path should not interfere with adjoining property drainage patterns.
- Rain gardens should not be located in areas where ponded water may create problems for surrounding vegetation or land use.
- Construction and planting should be as early in the spring as possible to take advantage of spring rains. Watering as needed during dry periods during the first year may be necessary until the vegetation is established.

8.1.5 Design Procedure and Criteria

The following steps outline the design procedure and criteria for a rain garden.

- Determine an appropriate area for constructing the rain garden. Rain gardens should be placed near the lowest point of a catchment area, on slope not exceeding two percent. The location selected should have sufficient area available for the rain garden.
- Examine existing soil conditions and perform percolation tests if necessary. A simple percolation test involves excavating a hole approximately six inches deep and 12 inches in diameter and filling it with water. If the water does not drain within 24 hours, the soil may not be suitable for a rain garden, or will require soil amendments or and engineered soil mix to facilitate infiltration. Depending on location, size of the rain garden, and local requirements, a professional engineer may be required to conduct a percolation test of the selected site.
- Size the rain garden to intercept runoff from a water quality storm event. Sizing calculations must include runoff coefficients for the type of groundcover within the rain garden catchment area. The “footprint” area of the rain garden can vary depending on the amount of rain fall runoff intercepted, and the depth of the type of soil. Ponding depth of the rain garden should be restricted to six inches or less.
- If possible, the soil should be native topsoil or similar, with at least two- to five-percent organic material (brown to near black coloration). Tight, clayey soils (typical of subsoils left as the soil surface in many residential areas) should be amended with organic supplements to increase porosity. Sandier soils may not need amendments.

- Using native soils are preferred for the rain garden. If an engineered soil mix is used, a 1:1 sand/compost mix is recommended. The engineered soil mix must be thoroughly homogenized prior to placement in the rain garden. The underlying native soil should be scarified prior to placement of the engineered soil mix. Soil mixes can actually vary to also include a small portion of topsoil. The amount of engineered soil mix to use should be determined from the sizing calculations of the rain garden, but the depth of the soil mix should not exceed two feet.
- A small berm may be included in the design of the rain garden on the down-hill side. The berm should be at least 12 inches wide and constructed of the native topsoil.
- A filter strip of grass (native preferred but not necessary) is recommended for reducing velocity and for filtering fine sediments before water enters the rain garden. For rain gardens collecting runoff from parking lots or paved areas, a buffer strip of river rock, at least 12 inches wide, is recommended to reduce flow velocity.
- A planting soil composed of topsoil and compost on the surface of the rain garden is recommended. Above the planting soil, a two- to three-inch layer of mulch should be placed after vegetation is planted.
- Plant selection will include native species that are tolerant of both wet and dry cycles will achieve the highest level of success in a rain garden. Other non-native species can be added. Deep rooted perennials are encouraged. Trees and shrubs are also commonly used in rain gardens.

8.1.6 Maintenance & Inspections

Rain gardens should be weeded weekly until native plants are established. Surface mulch will aid in reducing the growth of unwanted vegetation. Fertilizer applications should be avoided, and minimized near the rain garden. After the rain garden is established, dead vegetation should be removed each spring by mowing or burning (if allowed). Allowing vegetation that goes dormant in the fall or winter to remain provides food for birds through the winter. After the rain garden is established, periodic maintenance to remove non-native invasive or un-desired plants, or to cut back excessive growth is appropriate. The following table provides general maintenance guidance¹:

**TABLE 8.1
Typical Maintenance Activities for Rain Gardens**

Activity	Frequency
Water Plants	As necessary during first growing season
Water as necessary during dry periods	As needed after the first growing season
Re-mulch void areas	As needed
Treat diseased trees and shrubs	As needed
Inspect soil and repair eroded areas	Monthly
Remove litter and debris	Monthly
Add additional mulch	Once per year

8.1.7 Design Example

The procedure for sizing rain gardens is similar to the procedure for sizing bioretention cells without an underdrain system. See section 8.4.7 for example and omit the underdrain system design.

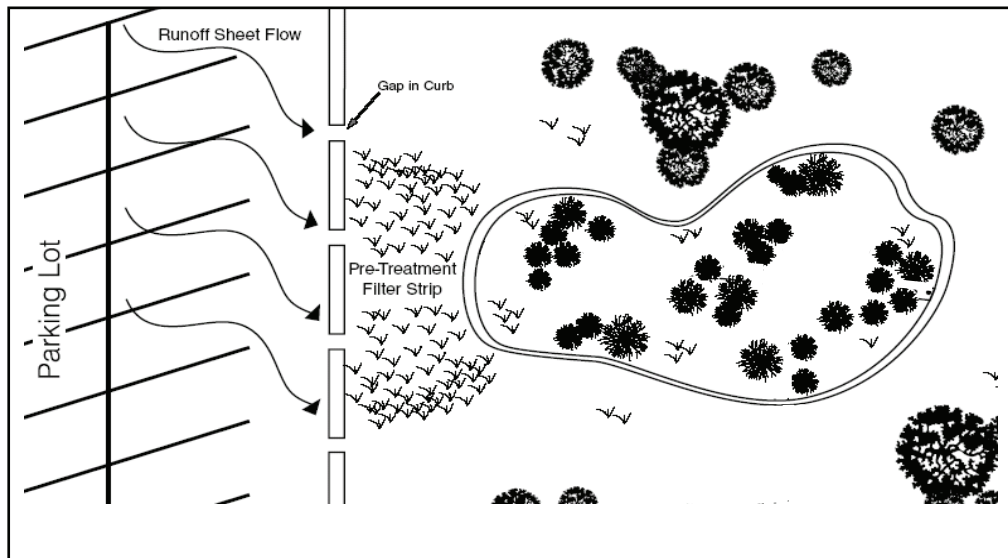
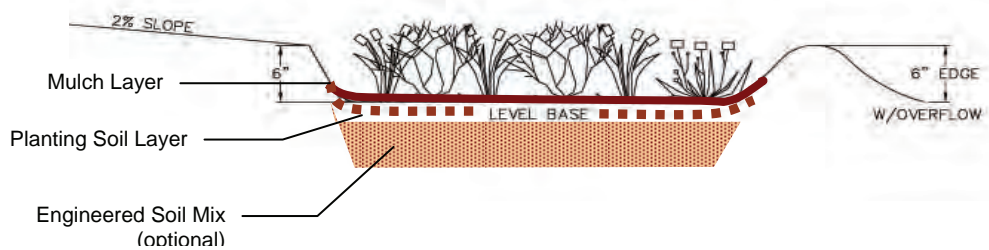

FIGURE 8.1 - Rain Garden Layout for Parking Lot Runoff



Typical Rain Garden Cross Section (Source: Pennsylvania Stormwater BMP Manual, 2005)

FIGURE 8.2 - Simplified Cross Section of Rain Garden Design

8.2 FILTRATION BASINS



Source: University of Wisconsin Extension-Water Resources Education

Targeted Constituents

Sediment	●
Nutrients	●
Trash	●
Metals	●
Bacteria	●
Oil and Grease	●
Organics	●

Legend (Removal Effectiveness)

High	Medium	Low
●	●	○

Source: California Stormwater Quality Association, California Stormwater Quality Association Stormwater Best Management Practice Handbook. 2003.

8.2.1 Description

Infiltration basins are earthen structures that capture a stormwater runoff volume, hold this volume, and infiltrate it into the ground over a period of days. Typical components of an infiltration basin include an inlet, sediment forebay, level spreader, principal spillway, a backup underdrain, emergency spillway, and a stilling basin. **Figure 8.3** illustrates a typical infiltration basin.

8.2.2 General Application

Infiltration basins are almost always placed off line and are designed only to intercept a certain volume of runoff. Any excess volume is bypassed. Vegetated infiltration systems help to prevent migration of pollutants; the roots of the vegetation can increase the permeability of the soils, thereby increasing the basin's efficiency. Infiltration basins typically are not designed to retain a permanent pool volume. Their main purposes are to transform a surface water flow into a groundwater flow and to remove pollutants through mechanisms such as filtration, adsorption, and biological conversion as the water percolates through the underlying soil. Design infiltration basins to drain within 72 hours to prevent mosquito breeding and potential odors from standing water, and to prepare the basin to receive runoff from the next storm (EPA, 1993a). Infiltration basins are also useful to help restore or maintain predevelopment hydrology in a watershed. Infiltration can increase the water table, increase baseflow, and reduce the frequency of bank-full flooding events. Infiltration basins are not well suited for drainage areas that deliver high concentrations of sediments. They are best used as a best management practice (BMP) toward the end of the treatment train. If groundwater is close to the surface, do not use an infiltration basin.

8.2.3 Advantages

- Reduce the volume of runoff from a drainage area
- Effectively remove fine sediment, trace metals, nutrients, bacteria, and oxygen-demanding substances (organics)
- Reduce downstream flooding and protect streambank integrity

- Reduce the size and cost of downstream stormwater control facilities and storm drain systems by infiltrating stormwater in upland areas
- Provide groundwater recharge and baseflow in nearby streams
- Reduce local flooding

8.2.4 Disadvantages

- Have potentially high failure rates due to improper siting, design, and lack of maintenance—especially if pretreatment is not incorporated into the design
- Carry a risk of groundwater contamination, depending on soil conditions and groundwater depth
- Have potential for clogging—not appropriate for treating significant loads of sediment and other pollutants
- Are not appropriate for industrial or commercial sites where release of large amounts or high concentrations of pollutants are possible
- Require flat continuous area
- Require frequent inspection and maintenance
- Have effectiveness limited to small sites (2 acres or less)

8.2.5 Design Requirements and Considerations

Restrict the contributing drainage area to any infiltration basin to 2 acres or less. Locate basins at least 150 feet away from drinking water wells to limit the possibility of groundwater contamination, and at least 10 feet downgradient and 100 feet upgradient from building foundations to avoid potential seepage problems. The length-to-width ratio for an infiltration basin should be 3:1 or greater. Grade the basin as flat as possible to provide uniform ponding and infiltration of the runoff across the floor. Be sure the side slopes of the basin are no steeper than 3 horizontal to 1 vertical (flatter slopes are preferred) to allow for proper vegetative stabilization, easier mowing, easier access, and better public safety. Select vegetation for the infiltration basin by its ability to withstand wet weather, drought, and short periods of ponding (Table 4.4 and Appendix A). Design the infiltration basin to store temporarily and infiltrate the WQv. The maximum depth of 2 feet and ponding time of the infiltration area should promote the survival of vegetation. Determine the ponding time by plant inundation tolerances—it must be no greater than 72 hours. Conservative estimates of soil infiltration rates are in county soil surveys published by the U. S. Department of Agriculture or are obtainable by field testing methods. After determining the infiltration rate of the soil, calculate the maximum depth of the infiltration basin using the following equation:

$$d_{\max} = (f)(T_p)$$

Where

d_{\max} = maximum design depth (inches)

f = soil infiltration rate (inches/hour)

T_p = design ponding time (hours)

Since infiltration basins are susceptible to high failure rates due to clogging from sediments, pretreating stormwater is necessary to remove as many suspended solids from the runoff as possible before the runoff enters the basin. The design of infiltration basins should include an appropriate combination of grit chambers (for pretreating), swales with check dams, filter strips, or sediment forebays and traps. Figure 8.3 shows an infiltration basin with pretreatment via a stilling basin.

If runoff is delivered by a storm drainpipe or along the main conveyance system, design the infiltration practice as an offline practice. To prevent incoming flow velocities from reaching erosive levels, stabilize inlet channels to the basin

with riprap or other suitable methods, and design inlet channels to terminate in a broad apron (spreads the runoff more evenly over the basin surface to promote better infiltration). Incorporate a bypass flow path or pipe in the design to convey high flows—from storms larger than the water quality storm—around the basin. All basins must have an emergency spillway capable of passing runoff from the 25-year, 24-hour storm without damage to the impounding structure.

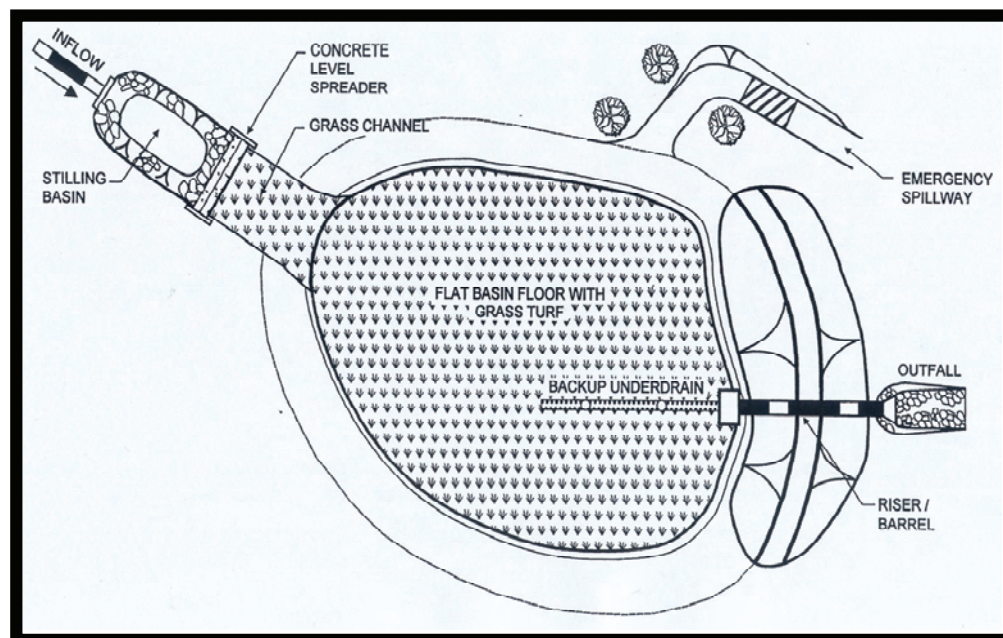

Source: CWP 1996

FIGURE 8.3 - Typical Infiltration Basin
(for informational purposes only)

8.2.6 Maintenance and Inspections

The following is a partial list of actions for proper upkeep of infiltration basins:

- Inspect and clean pretreatment devices associated with basins at least twice a year, and ideally every other month.
- Following every major storm for the first few months after the basin has gone on line, perform inspections to maintain proper stabilization and function. Pay attention to how long water remains standing in the basin after a storm; standing water within the basin more than 72 hours after a storm indicates the infiltration capacity may have been overestimated. Repair factors responsible for clogging (such as upland sediment erosion and excessive compaction of soils) immediately. Inspect newly established vegetation several times to determine if any remedial actions (e.g., reseeding, irrigation) are necessary.
- Thereafter, inspect the infiltration basin at least twice per year for differential accumulation of sediment, erosion of the basin floor, condition of riprap, and the health of the vegetation.
- Replant eroded or barren spots immediately after inspection to prevent additional erosion and accumulation of sediment.
- Remove sediment within the basin when the sediment is dry enough to crack and readily separates from the basin floor.
- To remove the top layer of sediment, use light equipment that will not compact the underlying soil.

- Control weed growth to maintain vegetation.

8.2.7 Design Example

See Addendum #1, to be completed at a later date.

8.3 INFILTRATION TRENCHES



Source: MDE Water Management Administration

Targeted Constituents

Sediment	○
Nutrients	●
Trash	●
Metals	●
Bacteria	●
Oil and Grease	●
Organics	●

Legend (Removal Effectiveness)

High	Medium	Low
●	◐	○

Source: California Stormwater Quality Association, California Stormwater Quality Association Stormwater Best Management Practice Handbook. 2003.

8.3.1 Description

Infiltration trenches are defined as excavated trenches filled with coarse granular material; they collect stormwater runoff for temporary storage and infiltration. Typically, infiltration trenches and wells can capture only a small amount of runoff and therefore may be designed to capture the first flush of a runoff event rather than the full water quality volume (WQv). For this reason, they frequently are combined with another best management practice (BMP) such as a detention basin to control peak hydraulic flows. Infiltration trenches and wells can remove suspended solids, particulates, bacteria, organics, soluble metals, and nutrients through mechanisms of filtration, absorption, and microbial decomposition.

8.3.2 General Application

Typical applications of infiltration trenches include runoff treatments for residential lots and small commercial lots. In densely populated areas where undeveloped land area is scarce, infiltration basins may not be practical or effective. For these areas, infiltration trenches should become part of a developer's initial master plan of future development.

Infiltration trenches promote groundwater recharge. But, as with all infiltration practices, the possibility for groundwater contamination must be considered where groundwater is a source of drinking water. Infiltration trenches also do not filter coarse sediments.

Estimates indicate that infiltration trenches can remove 95 percent of suspended solids, 42 percent of phosphorous, and 42 percent of nitrogen in the stormwater (Claytor and Schueler, 1996). Do not use them to treat highly contaminated runoff.

8.3.3 Advantages

Reduce the volume of runoff from a drainage area

- Remove fine sediment, trace metals, nutrients, bacteria, and oxygen-demanding substances (organics)

- Reduce the size and cost of downstream stormwater control facilities and storm drain systems by infiltrating stormwater in upland areas
- Provide groundwater recharge and baseflow in nearby streams
- Reduce local flooding
- Useful where space is limited because of their narrow dimensions

8.3.4 Disadvantages

- Should not be installed until the entire contributing drainage area has been stabilized
- Risk failure because of improper siting, design, and lack of maintenance especially if pretreatment is not incorporated into the design
- Risk contaminating groundwater depending on soil conditions, land use in the watershed, and groundwater depth
- Not appropriate for industrial or commercial sites where release of large amounts or high concentrations of pollutants is possible
- Susceptible to clogging by sediment, necessitating frequent maintenance
- Inappropriate where surrounding soils have low permeability rates
- Effectively limited to small sites (2 acres or less).

8.3.5 Design Requirements and Considerations

Restrict the contributing drainage area to any infiltration trenches to 5 acres or less. Design trenches to provide a detention time of 6 to 72 hours for the water quality storm. Provide a minimum drainage time of 6 hours for satisfactory pollutant removal in the infiltration trench. Adjust the depth of the trench so that maximum drain time based on soil permeability is 72 hours for the total design infiltration volume.

Accommodate the volume and surface area of an infiltration trench to the water quality storm volume of runoff entering the trench from the contributing watershed and the permeability of the soil below the trench. Conservative estimates of soil infiltration rates are obtainable in the county soil surveys published by the U. S. Department of Agriculture or through field testing methods in accordance with Natural Resources Conservation Service (NRCS) guidance. If stormwater is conveyed to the trench as uniform sheet flow, maximize the length of the trench perpendicular to the flow direction. If stormwater is conveyed as channel flow, maximize the length of the trench parallel to the direction of flow. Calculate the appropriate bottom area of the trench using the following equation:

$$A = \frac{12(V)}{(P)(n)(t)}$$

Where

A =bottom area of the trench (square feet)

V =runoff volume to be infiltrated (cubic feet)

P = percolation rate of surrounding native soil (inches per hour)

N = void space fraction in the storage media (0.4 for clear stone)

t = retention time (maximum of 72 hours)

Create trench depths between 3 and 8 feet. Calculate a site-specific, maximally effective trench depth based on the soil percolation rate, aggregate soil space, and the trench storage time using the following equation:

$$D = \frac{(P)(t)}{(n)(12)}$$

Where

D = depth of the trench in feet

P = percolation rate of surrounding existing soil (inches per hour)

t = retention time (maximum of 72 hours)

n = void space fraction in the storage media (0.4 for clear stone)

Line the sides and bottom of the infiltration trench with geotextile fabric (filter fabric). Place a layer of nonwoven filter fabric 6 to 12 inches below the ground surface to prevent suspended solids from clogging the majority of the storage media. The filter fabric material must be compatible with the surrounding soil textures and application purposes. The cut width of the filter fabric must have sufficient material for a minimum 12-inch overlap. When overlaps are required between rolls, the upstream roll must lap a minimum of 2 feet over the downstream roll to provide a shingled effect. In place of filter fabric, cover the bottom of the infiltration trench with a 6-inch to 12-inch layer of clean sand.

The basic infiltration trench design uses stone aggregate in the top of the trench to provide storage. Fill the trench with clean washed stone (diameter of 1.5 to 2.5 inches) to provide a void space of 40 percent. Pea gravel or soil may be substituted for stone aggregate in the top 1 foot of the trench to improve sediment filtering and maximize pollutant removal at the top of the trench. Plant the infiltration trench with vegetation that can withstand periods of saturation and drought. Review and implement alternative storage media solutions case by case until adequate research and experience indicate how they perform.

An observation well located at the center of the trench to monitor water drainage from the system is required. The well should be 4-inch to 6-inch diameter PVC pipe anchored vertically to a footplate at the bottom of the trench. The well should have a lockable aboveground cap.

To remove as many suspended solids from the runoff as possible before they enter the trench, incorporate pretreatment such as grit chambers, swales with check dams, filter strips, or sediment forebays and traps as a component of infiltration trench design. Pretreatment helps maintain the infiltrating facility and extends periods between maintenance. Incorporate a bypass flow path in the design to convey high flows (storms larger than the water quality storm) around the trench. To preclude erosive concentrated flows, manage the overland flow path of the surface runoff that exceeds the capacity of the infiltration trench.

8.3.6 Other Design Criteria Considerations

- Infiltration trenches should have an approximate depth of 3 to 8 feet. Design the volume of the trench to accommodate the water quality storm runoff per tributary acre within the depth of 3 to 8 feet. A standard length to width ratio is not recommended since the infiltration rate of the soil dictates the dimensions of the trench.
- A typical cross section for an infiltration trench includes a filter fabric lined trench, optional underdrain, and coarse granular material topped with clean compacted soil or gravel that can be planted with various species of vegetation. The clean stone diameters should be 1.5 to 2.5 inches. Install the optional underdrain to convey excess stormwater to the storm drain system. Install an observation well in conjunction with an infiltration trench. Install overflow devices so that storm events can bypass the infiltration trench to a safe point downstream.

-
- Locate infiltration trenches where the contributing drainage area is 5 acres or less, slopes are 5 percent or less, and surrounding soils have less than 40 percent clay and permeability rates of 0.5 to 2.0 inches per hour. The surrounding soil should also have a high, available, water holding capacity.
 - Do not use limestone or shale as backfill material of the infiltration trench since they may cement over time. The filter fabric should be permeable enough for the trench to drain the design storm within 72 hours.
 - Stabilize the contributing drainage area for erosion control before installing an infiltration trench. Use multiple pretreatment techniques together with infiltration trenches to eliminate potential clogging and to increase the lifespan of the trench. Install a 20-foot-minimum wide grass filter upslope of the infiltration trench to help remove coarse sediments from the stormwater. **Figure 8.4** illustrates a typical infiltration trench.

8.3.7 Maintenance and Inspections

Following is a partial list of actions to upkeep infiltration trenches:

- Once the trench enters operation, inspect it after every major storm for the first few months to maintain proper stabilization and function. Record water levels in the observation well for several days to check trench drainage.
- Inspect for ponding after storm events to make sure the trench is not clogged.
- Frequently remove sediment from pretreatment facilities.
 - ◇ When ponding occurs at the surface or in the trench, undertake corrective maintenance immediately.
 - ◇ Remove grass clippings, leaves, and accumulated sediment routinely from the surface of the trench.
- Ponded water inside the trench (visible from the observation well) after 24 hours or several days following a storm event indicates the bottom of the trench is clogged. Remove and replace all of the stone aggregate and filter fabric or media.

Infiltration Trench

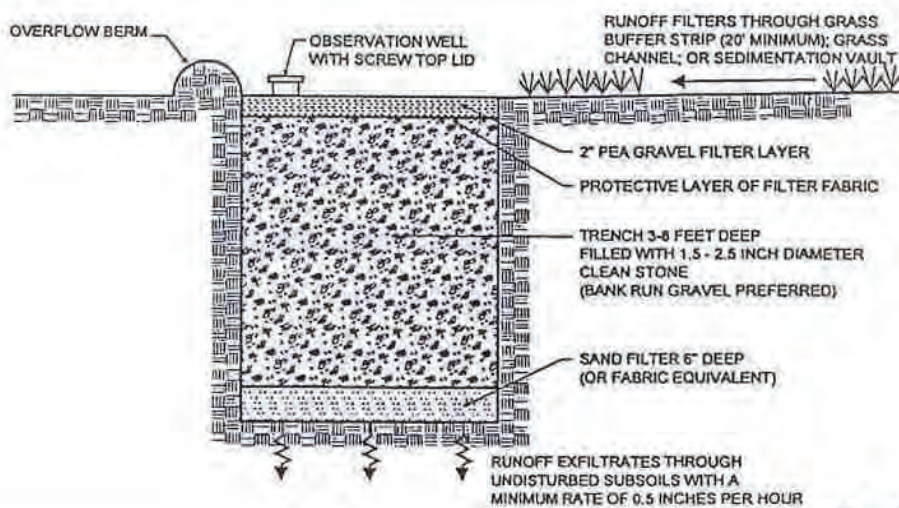
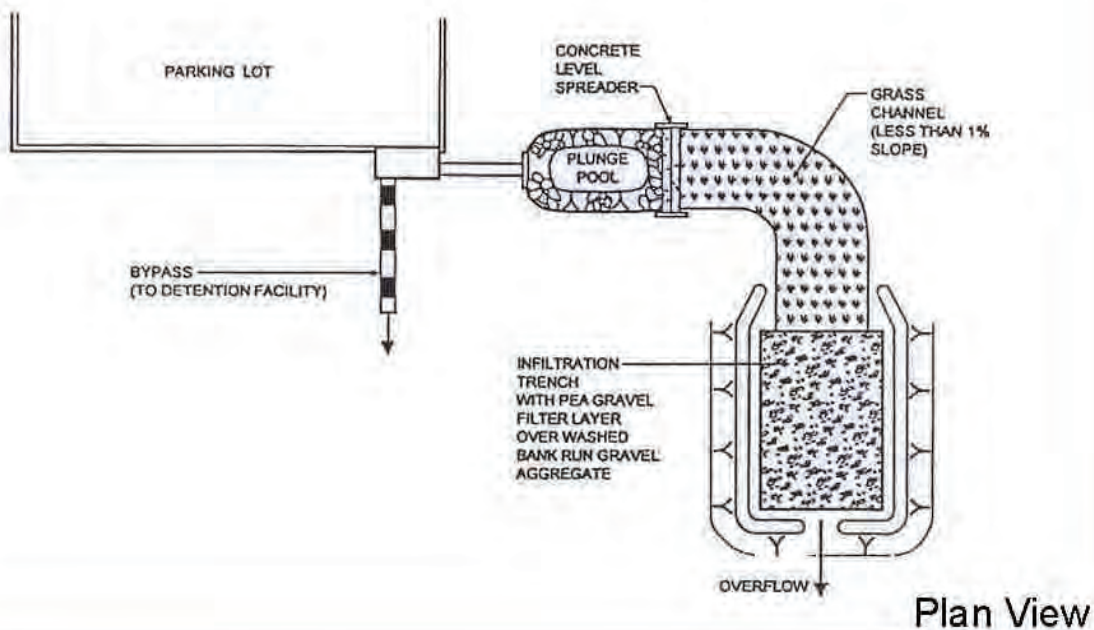

Source: CWP 1996

FIGURE 8.4 - Infiltration Trench Plan and Profile Example
(for informational purposes only)

8.3.8 Design Example

To be completed at a later date.

8.4 BIORETENTION



Source: City of Lenexa, Kansas

Targeted Constituents	
Sediment	●
Nutrients	●
Trash	●
Metals	●
Bacteria	●
Oil and Grease	●
Organics	●

Legend (Removal Effectiveness)		
High	Medium	Low
●	◐	○

Source: California Stormwater Quality Association, 2002

8.4.1 Description

Bioretention is a best management practice (BMP) that filters, uptakes, and infiltrates stormwater runoff by way of the natural chemical, biological, and physical properties of plants, microbes, and soils (Programs & Planning Division, Department of Environmental Resources, Prince George's County, MD, Revised 2002) (CDM, 1989, 2001). The practice gets its name from the ability of the biomass within a small landscaped basin to retain the water quality volume (WQv) and remove nutrients and other pollutants from stormwater runoff (Programs & Planning Division, Department of Environmental Resources, Prince George's County, MD, Revised 2002). The runoff's velocity is reduced by passing the runoff over or through a pretreatment device and subsequently distributing it evenly along a ponding area (Urban Drainage and Flood Control District - Denver, Colorado, 2005). The WQv is allowed to infiltrate into the surrounding soil naturally or be collected by an underdrain system that discharges to the storm sewer system or directly to receiving water. Runoff in excess of the water quality storm is passed through or around the facility via an overflow structure.

Bioretention controls runoff close to the source. Unlike end-of-pipe BMPs, bioretention facilities are typically shallow depressions located in upland areas. The strategic, uniform distribution of bioretention facilities across a development site results in smaller, more manageable subwatersheds, and thus, will help in controlling runoff close to the source where it is generated to promote recharge. This is beneficial in that it reduces the amount of runoff that must be managed further downstream, thus reducing the cost and land area required for large regional BMPs (Programs & Planning Division, Department of Environmental Resources, Prince George's County, MD, Revised 2002).

8.4.2 General Application

Bioretention typically treats stormwater that has run over impervious surfaces at commercial, residential, and industrial areas (Urban Drainage and Flood Control District - Denver, Colorado, 2005). For example, bioretention is an ideal BMP to be used in median strips, parking lot islands, and landscaped swales. These areas can be designed or modified so that runoff is either diverted directly into the bioretention area or conveyed into the bioretention area by

a curb and gutter collection system (Urban Drainage and Flood Control District - Denver, Colorado, 2005) (Office of Water, EPA, 1999).

Bioretention is usually most effective when used upland from inlets that receive sheet flow from graded areas. Bioretention can also be applied effectively where runoff is collected from impervious areas and discharged to a bioretention cell. To maximize treatment effectiveness, the site must be graded in such a way that minimizes erosive conditions as sheet flow is conveyed to the treatment area. Locations where a bioretention area can be readily incorporated into the site plan without further environmental damage are preferred. Furthermore, to effectively minimize sediment loading in the treatment area, bioretention only should be used in stabilized tributary areas (Urban Drainage and Flood Control District - Denver, Colorado, 2005) (Office of Water, EPA, 1999).

8.4.3 Advantages

- Bioretention facilities use minimal land area (1 to 15 percent of total tributary area) and can therefore be sited in locations that are unsuitable for other BMPs.
- Bioretention is easily incorporated in a BMP treatment train.
- Bioretention reduces peak runoff rate and volume from a site for small frequent storms and may reduce the total volume that must be managed further downstream (depending on the amount of retention).
- Bioretention has one of the highest nutrient and pollutant removal efficiencies of any BMP.
- Properly designed and maintained bioretention provides aesthetic enhancement. When aesthetic features are incorporated into bioretention designs, they encourage environmental stewardship and community pride. (Programs & Planning Division, Department of Environmental Resources, Prince George's County, MD, Revised 2002).
- When constructed in areas with porous native soil, bioretention facilities can contribute to groundwater recharge.
- By intercepting runoff in bioretention areas near the source, the amount of the stormwater management infrastructure may be reduced, resulting in significant cost savings in site work (Programs & Planning Division, Department of Environmental Resources, Prince George's County, MD, Revised 2002) (CDM, 2001). Bioretention facilities reduce the temperature of water discharged from the overall system (CDM, 2001).

8.4.4 Disadvantages

- Bioretention should not be installed until the entire tributary area has been stabilized; otherwise, silt from unstabilized areas can clog the bioretention facility.
- Bioretention is not a suitable BMP at locations where the wet season water table is within 1 to 2 feet of the ground surface and where the surrounding soil stratum is unstable. Too shallow of a water table can prevent runoff from draining completely through the bioretention soil mixture (CDM, 1989, 2001).
- Bioretention is not recommended for upland areas with slopes greater than 20 percent; otherwise, clogging may be a problem, particularly if the area receives runoff with high sediment loads. If clogging occurs, unclogging can be difficult (Office of Water, EPA, 1999).
- Bioretention is not recommended for areas where mature tree removal would be required (Office of Water, EPA, 1999). Existing trees should be incorporated into the bioretention facility where applicable.
- Flood control features are not easily incorporated into bioretention.
- Bioretention is most effective for tributary areas of less than 4 acres.
- Bioretention requires a specific soil matrix to provide a minimum saturated vertical hydraulic conductivity (See **Appendix A** for specification).

-
- Bioretention may not effectively remove pollutants immediately after construction. Pollutant removal efficiency increases as vegetation becomes established.

8.4.5 Design Requirements and Considerations

Design specifications for bioretention facilities are given in **Appendix A**.

One of the unique qualities of bioretention is the flexibility of design themes that a designer may employ when integrating into the site. Making multi-functional use of existing site constraints, bioretention can blend nicely with buffers, landscape berms, and environmental setback areas (Programs & Planning Division, Department of Environmental Resources, Prince George's County, MD, Revised 2002). Additionally, the layout of the bioretention area is determined after site constraints such as location of utilities, underlying soils, existing vegetation, and runoff are considered (Office of Water, EPA, 1999) (Programs & Planning Division, Department of Environmental Resources, Prince George's County, MD, Revised 2002). **Figure 8.5** illustrates the composition of a sample bioretention facility. The following guidelines are to be considered when designing bioretention facilities:

- Bioretention facilities shall not be constructed within stream buffers or in areas adjacent to streams where sediment may be deposited during flood events.
- Bioretention facilities shall not be constructed until all tributary areas are permanently stabilized against erosion and sedimentation. Any discharge of sediment to the cell will require reconstruction of the cell to restore its defined performance.
- The bioretention facility shall be designed to capture the WQv. The WQv should filter through the facility's planting soil bed in 1 to 3 days.
- Recommended minimum dimensions are 15 feet wide by 40 feet long, although the preferred dimensions are 25 feet wide by 50 feet long, allowing enough space for a dense, randomly distributed area of plants and shrubs to become established while decreasing the chances of concentrated flow. Essentially, any facilities wider than 20 feet shall be twice as long as they are wide (Urban Drainage and Flood Control District - Denver, Colorado, 2005).
- The tributary area for a bioretention area shall be less than 4 acres. Multiple bioretention areas may be required for larger tributary areas (Office of Water, EPA, 1999). Inflow velocities to bioretention facilities shall be reduced to below erosive levels (generally 3 feet per second) upstream of the facility.

8.4.5.1 Excavation

- The bioretention facility can be excavated before final stabilization of the tributary area; however, the bioretention soil mixture and underdrain system shall not be placed until the entire tributary area has been stabilized. Any sediment from construction operations deposited in the bioretention facility shall be completely removed from the facility after all vegetation, including landscaping within the tributary area to the bioretention facility, has been established. The excavation limits shall then be final graded to the dimensions, side slopes, and final elevations as specified in the construction.
- Low ground-contact pressure equipment, such as excavators and backhoes, is preferred on bioretention facilities to minimize disturbance to established areas around the perimeter of the cell. No heavy equipment shall operate within the perimeter of a bioretention facility during underdrain placement, backfilling, planting, or mulching of the facility.
- Bioretention facility side slopes shall be excavated at 4:1 or flatter.

8.4.5.2 Underdrain or Outlet

The underdrain increases the ability of the soil to drain quickly and in so doing keeps the soil at an adequate aerobic state, allowing plants to flourish. The use of an underdrain system to provide a discharge point precludes the need for

extensive geotechnical investigation. Underdrains are configured in many different ways and typically include a gravel/stone “blanket” encompassing a horizontal, perforated discharge pipe. An aggregate can be used to protect the underdrain from clogging (Programs & Planning Division, Department of Environmental Resources, Prince George’s County, MD, Revised 2002).

- Design the underdrain system with the following components: a 4-inch minimum perforated pipe system with an 8-inch gravel bed. Filter fabric shall be placed around the gravel bed to separate it from the planting soil bed. The pipe shall have perforations between 0.25 and 0.375 inches diameter, spaced at 6-inch centers, with a minimum of 4 holes per row. The pipe(s) shall be placed with one header and several branches or several headers such that the maximum flow path has a length of 5 feet when viewed in plan. Maintain a minimum grade of 0.5 percent. See specification in **Appendix A** for additional underdrain system design criteria.
- Provide at least one cleanout per run and every 50 feet or less.
- Connect the underdrain system to the conventional stormwater management system, or daylight it to a suitable nonerosive outfall.
- A valve or cap at the end of the underdrain system may be provided to allow for the possibility of closing off the underdrain. This will enable longer retention times, which will allow plants more opportunity for nutrient uptake and more groundwater recharge.

After placing the underdrain and aggregate and before placing the bioretention soil mixture (BSM), the bottom of the excavation shall be rototilled to a minimum depth of 6 inches to alleviate any compaction of the facility bottom. Any ponded water shall be removed from the bottom of the facility, and the soil shall be friable before rototilling. The rototilling shall not be done where the soil supports the aggregate bed underneath the underdrain.

8.4.5.3 *Overflow*

The overflow component of the bioretention system consists of the gravel underdrain system, an aggregate overflow curtain drain, and a high-flow overflow structure (Programs & Planning Division, Department of Environmental Resources, Prince George’s County, MD, Revised 2002). In a residential setting, overflow usually does not present a problem for two reasons: (1) the tributary area and facility capacity are relatively small, and (2) the system is located within grassy areas that provide a safe, nonerosive surface for any overflow conditions that may arise. Additionally, residential bioretention facilities are typically designed off line and already incorporate a safe overland flow path. In commercial or industrial settings, design for overflow is more critical. Often, facilities in commercial settings are incorporated into the parking lot landscape islands. The paved surfaces flowing to the facilities can generate large quantities of runoff. Designers are required to provide a safe discharge point (Programs & Planning Division, Department of Environmental Resources, Prince George’s County, MD, Revised 2002).

- Bioretention can be designed to be off line or on line of the existing stormwater management system (Office of Water, EPA, 1999). If the system is off line, design the overflow to convey peak discharge of the WQv and set it above the shallow ponding limit. If the facility is on line, design the high flow overflow as a conventional stormwater control structure or channel. Connect the overflow structure to the site stormwater management system, or outfall to a suitable nonerosive location.
- The high flow overflow system is usually a yard drain catch basin, but any number of conventional management practices may be used, including an open vegetated or stabilized channel.
- Bioretention facilities shall be designed so that runoff flows from storm events greater than the water quality event, up to and including the 1 percent event, safely pass through or around the facility. If the 1 percent event is to pass through the facility, the maximum velocity shall be kept below 3 feet per second to avoid erosion of the soil matrix. If facilities are designed with a bypass, it shall be designed to safely pass runoff flows from events up to and including the 1 percent event. At a minimum, all facility embankments shall be protected from failure during the 1 percent event.

8.4.5.4 Aggregate

An aggregate, which provides a greater porosity and is less likely to clog, is preferred (Programs & Planning Division, Department of Environmental Resources, Prince George's County, MD, Revised 2002).

It is recommended to have an aggregate layer around the perforated pipe to facilitate drainage. Refer to the specification in **Appendix A**.

8.4.5.5 Sand Bed

The sand bed is an optional feature that underlies the planting soil bed and allows water to drain from the planting soil bed into the surrounding soil. It provides additional filtration and allows aeration of the planting soil bed (Office of Water, EPA, 1999).

8.4.5.6 Planting Soil Bed

The soil characteristics are critical for the proper operation of the bioretention facility. The planting soil, called the BSM, provides the water and nutrients for the plants to sustain growth (Programs & Planning Division, Department of Environmental Resources, Prince George's County, MD, Revised 2002). The BSM is a mixture of organic mulch, planting soil, and sand. To enhance nutrient uptake, the soil must have a combination of chemical and physical properties to support a diverse microbial community.

- The planting soil shall have a minimum depth of approximately 2.5 feet to provide adequate moisture capacity and to create space for the root system of the plants. Root balls of many trees will require additional depths (Programs & Planning Division, Department of Environmental Resources, Prince George's County, MD, Revised 2002). Planting soil shall be 4 inches deeper than the bottom of the largest root ball and a maximum of 4 feet altogether. Planting soil depths greater than 4 feet may require additional construction practices, such as shoring measures (Urban Drainage and Flood Control District - Denver, Colorado, 2005) (Office of Water, EPA, 1999).
- The BSM shall be free of stones, stumps, roots, or other weedy material over 1 inch in diameter, excluding the mulch. Brush or seeds from noxious weeds shall not be present in the solids. Refer to the specification in **Appendix A**.

8.4.5.7 Organic or Mulch Layer

The organic layer (mulch) protects the soil bed from erosion, retains moisture in the plant zone, provides a medium for biological growth and decomposition of organic matter, and filters pollutants (Programs & Planning Division, Department of Environmental Resources, Prince George's County, MD, Revised 2002).

- Following placement of any trees and shrubs, the ground cover and/or mulch shall be established at an appropriate depth during the establishment period. Ground cover such as grasses or legumes can be planted at the beginning of the growing season (Urban Drainage and Flood Control District - Denver, Colorado, 2005). Mulching shall be complete within 24 hours after the trees and shrubs are planted to reduce the potential of silt accumulation on the surface (Urban Drainage and Flood Control District - Denver, Colorado, 2005).
- Pine mulch and wood chips are not acceptable in the mulch layer because they are displaced during storm events (Programs & Planning Division, Department of Environmental Resources, Prince George's County, MD, Revised 2002). Grass clippings are not allowed in the mulch layer. Refer to the specification in **Appendix A**.

8.4.5.8 Plant Materials

The role of plant species in the bioretention concept is to bind nutrients and other pollutants by plant uptake, to remove water through evapotranspiration, and to create pathways for infiltration through root development and plant

growth. Root growth provides a media that fosters bacteriologic growth, which in turn develops a healthy soil structure. Proper selection and installation of plant material is key to the success of the bioretention system.

- The designer should assess aesthetics, site layout, natural function, and maintenance requirements when selecting and placing plant species (Office of Water, EPA, 1999).
- Native grasses and other various local ground covers can be incorporated into a bioretention planting scheme. Trees and shrubs are also beneficial in wider facilities (minimum of 15 to 20 feet) because they create shade. Shade helps reduce runoff temperature and can be seen as an amenity in applications such as parking lots.
- See specification in **Appendix A** for appropriate plant materials.

8.4.5.9 Ponding Area

The ponding area provides temporary surface storage of stormwater runoff before it filters through the soil bed and facilitates the evaporation of a portion of the runoff (Office of Water, EPA, 1999) (Programs & Planning Division, Department of Environmental Resources, Prince George's County, MD, Revised 2002). The ponding area (A_p) is the actual footprint of the Bioretention cell. Settling of the particulates occurs in the ponding area and provides an element of pretreatment. Ponding design depths shall be kept to a minimum to reduce hydraulic overload of in situ soils/soil medium and to maximize the surface area to facility depth ratio (Programs & Planning Division, Department of Environmental Resources, Prince George's County, MD, Revised 2002). The ponding area shall have a maximum depth of 12 inches. However, a depth of 3 to 4 inches is preferable (Urban Drainage and Flood Control District - Denver, Colorado, 2005).

8.4.5.10 Pretreatment

The best method of capturing and treating runoff is to allow the water to sheetflow into the facility over grassed areas to reduce inflow velocity and to reduce the load of coarse sediment entering the bioretention area (Programs & Planning Division, Department of Environmental Resources, Prince George's County, MD, Revised 2002). When site constraints or space limitations impede sheetflow, flow entrances shall be created that reduce the velocity of the water. Possible Pretreatment alternatives include:

- **Vegetated Pretreatment Strip.** Runoff enters the bioretention area as sheet flow through the vegetated pretreatment strip, which can be planted with native grass or turf-forming grass. The filter strip reduces incoming runoff velocity and filters particulates from the runoff (Office of Water, EPA, 1999). Several factors determine the length in the direction of flow of the vegetated pretreatment strip, including size and imperviousness of the tributary area and filter strip slope. If a vegetated pretreatment strip is used, its length shall be 10 feet at a minimum. See **Table 8.2** for vegetated pretreatment strip sizing guidelines.
- **Vegetated Pretreatment Channel.** For sites where concentrated or channelized runoff enters the bioretention system, such as through a slotted curb opening, a vegetated channel with an aggregate is the preferred pretreatment method. This channel can also be planted with native grass or turf-forming grass. The length in the direction of flow of the vegetated pretreatment channel depends on the tributary area, land use, and channel slope. When a vegetated channel is used, the minimum length shall be 25 feet. See **Table 8.3** for vegetated channel sizing guidelines.
- In the case of parking lot landscape islands, curb cuts protected with energy dissipaters such as landscape stone or surge stone can be used. It is important to note that entrances of this type will tend to become obstructed with sediment and trash that settles out at lower velocities. This is not a problem as long as routine parking lot maintenance is performed (Programs & Planning Division, Department of Environmental Resources, Prince George's County, MD, Revised 2002).
- Baffle boxes or other pretreatment devices can be used as a pretreatment to flow entering a bioretention facility from a piped system. This form of pretreatment serves to settle out solids and slow the velocity of

flow. Cisterns placed at the bottoms of roof downspouts can be used to slow the velocity of runoff coming from rooftops and direct it to landscaped swale.

8.4.6 Maintenance and Inspections

By design, bioretention does not require intense maintenance efforts. Proper maintenance will increase the expected life span of the facility and will improve aesthetics (Programs & Planning Division, Department of Environmental Resources, Prince George's County, MD, Revised 2002).

The primary maintenance requirement for bioretention areas is that of inspection and repair or replacement of the treatment area's components. Generally, this involves nothing more than the routine periodic maintenance that is required of any landscaped area. Plants that are appropriate for the site, climatic, and watering conditions should be selected for use in the bioretention cell. Appropriately selected plants will aid in reducing fertilizer, pesticide, water, and overall maintenance requirements. Bioretention system components should blend over time through plant and root growth, organic decomposition, and the development of a natural soil horizon. These biologic and physical processes over time will lengthen the facility's life span and reduce the need for extensive maintenance (Urban Drainage and Flood Control District - Denver, Colorado, 2005).

Routine inspections for areas of standing water and corrective measures to restore proper infiltration rates are necessary to prevent creating mosquito and other vector habitat. In addition, bioretention areas are susceptible to invasion by aggressive plant species such as cattails, which increase the chances of water standing and subsequent vector production if not routinely maintained (Urban Drainage and Flood Control District - Denver, Colorado, 2005).

Bioretention maintenance resembles that of any maintained landscaping area. Following is a partial list of maintenance actions to upkeep bioretention:

- Inspect biannually for erosion of pretreatment and bioretention areas.
- Mulch as needed to cover bare soil. Spot mulching may be adequate when there are random void areas (Urban Drainage and Flood Control District - Denver, Colorado, 2005) (Office of Water, EPA, 1999). The old mulch shall be removed before the new mulch is distributed. Old mulch shall be disposed of properly (Office of Water, EPA, 1999).
- Annually inspect vegetation to evaluate its health and remove any dead or severely diseased vegetation (Office of Water, EPA, 1999).
- If stressed vegetation is present, further soil investigation is needed. If soil is contaminated, full or partial soil replacement in the planting zone is required.
- Diseased vegetation shall be treated as necessary using preventative and low-toxic measures to the extent possible (Office of Water, EPA, 1999).
- Annually inspect overflow devices.
- Remove trash and sediment as necessary (Programs & Planning Division, Department of Environmental Resources, Prince George's County, MD, Revised 2002).
- Aerate periodically.

8.4.7 Design Example

Below is a bioretention facility design example. These procedures follow the steps outlined in the Design Procedure Form: Bioretention, Main Worksheet. When using the worksheet in electronic form, manually enter values in green.

Example: Design a bioretention facility to treat runoff from the water quality rainfall event for the Kansas City Metropolitan Area (1.37 inches) coming off a ½-acre paved parking lot.

I. Basin Water Quality Storage Volume

Step 1 - Enter the tributary area to the bioretention facility (A_T).

Step 2 - Calculate the WQv using the methodology in Section 6 of this manual.

Ila. Pretreatment

Step 1 - Specify the type of inflow to the facility as either sheetflow or concentrated/channelized flow.

Step 2 - Specify the type of pretreatment to use (vegetated filter strip, vegetated channel or other pretreatment device).

Step 3 - Proceed to Part IIb, IIc, or IId for design guidance on different pretreatment options.

IIb. Vegetated Pretreatment Strip

Step 1 - Specify the type of land cover of the contributing area to the facility.

Step 2 - Enter the maximum inflow approach length (L_{approach}). This is the maximum length that runoff will flow across the parking lot before hitting the bioretention facility.

Step 3 - Enter the average slope of the vegetated filter strip (S_{f5}). This slope should not exceed 6 percent.

Step 4 - Determine the minimum required length for the filter strip (L_{fs}) from **Table 8.2**.

IIc. Vegetated Pretreatment Channel

Step 1 - Enter the percent imperviousness of the contributing area to the facility (% imp).

Step 2 - Enter the average slope of the vegetated channel (S_{vc}). This slope should not exceed 6 percent.

Step 3 - Determine the minimum required length for the vegetated channel (L_{vc}) from **Table 8.3**.

IId. Other Pretreatment Devices

Other methods of pretreatment may be used upstream of a bioretention facility to settle out suspended solids and reduce runoff velocity. Several proprietary devices are available that will achieve these results. Most of these devices are installed below ground and accept inflow from a piped stormwater management system or from surface sheetflow via drop inlets. These devices should be selected and sized based on site-specific conditions for each project and according to manufacturer instructions.

III. Planting Soil Bed and Ponding Area

Step 1 - Enter the planting soil bed depth (d_f). This depth can range from 2.5 feet to 4 feet. Soil bed depths greater than 4 feet may require additional construction practices such as shoring measures.

Step 2 - Enter the coefficient of permeability for the soil bed (k). The soil bed mixture should be tested before construction of the facility to ensure that it meets the desired permeability. This value should be at least 1 ft/day.

Step 3 - Enter the maximum ponding depth in the facility (h_{max}). This depth should be between 3 and 12 inches.

Step 4 - Calculate the average height of water above the bioretention bed (h_{avg}) as half the depth set in Step 3.

$$H_{\text{avg}} = H_{\text{max}}/2$$

Step 5 - Enter the time required for the WQv to filter through the planting soil bed (t_f). A time of 3 days is recommended.

Step 6 - Calculate the required filter bed surface area (A_f). See equation derivation on the Variable Dictionary sheet of the Bioretention Design Procedure Form.

$$A_f = (WQv * d_f) / [k * t_f * (h + d_f)]$$

Step 7 - Calculate the approximate filter bed length (L_f). Optimally the facility will be twice as long as it is wide. The facility length should be at least 40 feet.

Step 8 - Calculate the approximate filter bed width (W_f). This dimension should be approximately half the filter bed length, and should be at least 15 feet.

Step 9 - Calculate the Ponding Area (A_p).

IV. Underdrain

Step 1 - Set the underdrain pipe diameter (D_U). This value should be at least 4 inches.

Step 2 - Determine the depth of the gravel blanket (Z_{gravel}) around the underdrain pipe. This depth should be no less than 8 inches and should be at least 2 inches greater than the underdrain pipe diameter.

Step 3 - Set underdrain perforation diameter to 0.375 inches.

Step 4 - Set the longitudinal center-to-center underdrain perforation spacing (S_{perf}) as 6 inches.

Step 5 - Set the number of perforations per row (n_{perf}) (around the circumference of the underdrain pipe). This number should be at least 4.

Step 6 - Determine whether or not it is necessary to include transverse collector pipes that run perpendicular to and connect to the main underdrain pipe. If the bioretention facility width is greater than 10 feet, it will be necessary to include transverse collector pipes or additional parallel pipes.

Step 7 - Set the underdrain transverse collector pipe spacing (S_U) center-to-center. This distance should be no more than 10 feet.

Step 8 - Determine the number of transverse collector pipes (n_{pipe}) to cover the length of the facility based on the spacing from Step 8.

Step 9 - Ensure that the grade for all underdrain pipes (G_{pipe}) is at least 0.5 percent.

Step 10 - Ensure that one cleanout is provided at the end of each pipe run.

V. Overflow

The bioretention overflow shall be designed to safely pass runoff flows from events up to and including the 1 percent event unless the facility is designed with a bypass around the facility for larger storm events. If the 1-percent event is to pass through the facility, the maximum velocity shall be kept below 3 feet per second to avoid erosion of the soil matrix. If facilities are designed with a bypass, it shall be designed to safely pass runoff flows from events up to and including the 1 percent event. The overflow can be designed as a vegetated or stabilized channel or a yard inlet catch basin. Vegetated or stabilized channel overflows shall be designed using one of the methods presented in APWA Section 5603 and shall conform to the design criteria presented in APWA Section 5607. Methods presented in APWA Section 5604 shall be used for overflow inlet design.

VI. Vegetation

Enter a description of the mix and density of vegetation that will be planted in the bioretention facility. Follow guidance given in **Appendix A** of this manual. It is beneficial to plant variable types and species of plants in a bioretention facility. Such variability prevents single-species susceptibility to disease and insect infestation and provides a more aesthetic appearance. Native species should be used because they are more likely to thrive in the local climate. A minimum of three native species of shrubs and three native species of plants is recommended. Plants should also be selected for their ability to withstand extended dry conditions (which are likely to occur in parking lot island bioretention facilities) and periodic inundation.

TABLE 8.2
Vegetated Pretreatment Strip Sizing Guidance

Parameter	Impervious Parking Lots				Residential Lawns				Notes
Maximum Inflow Approach Length (feet)	35		75		75		150		
Filter Strip Slope	≤2%	≥2%	≤2%	≥2%	≤2%	≥2%	≤2%	≥2%	Maximum Slope = 6%
Filter Strip Minimum Length (feet)	10	15	20	25	10	12	15	18	

TABLE 8.3
Vegetated Pretreatment Channel Sizing Guidance for a 1.0-Acre Tributary Area

Parameter	≤33% Impervious		Between 34% and 66% Impervious		≥67% Impervious		Notes
Channel Slope	≤2%	≥2%	≤2%	≥2%	≤2%	≥2%	Maximum Slope = 6%
Grass Channel Minimum Length (feet)	25	40	30	45	35	50	Assumes bottom width is 2 feet

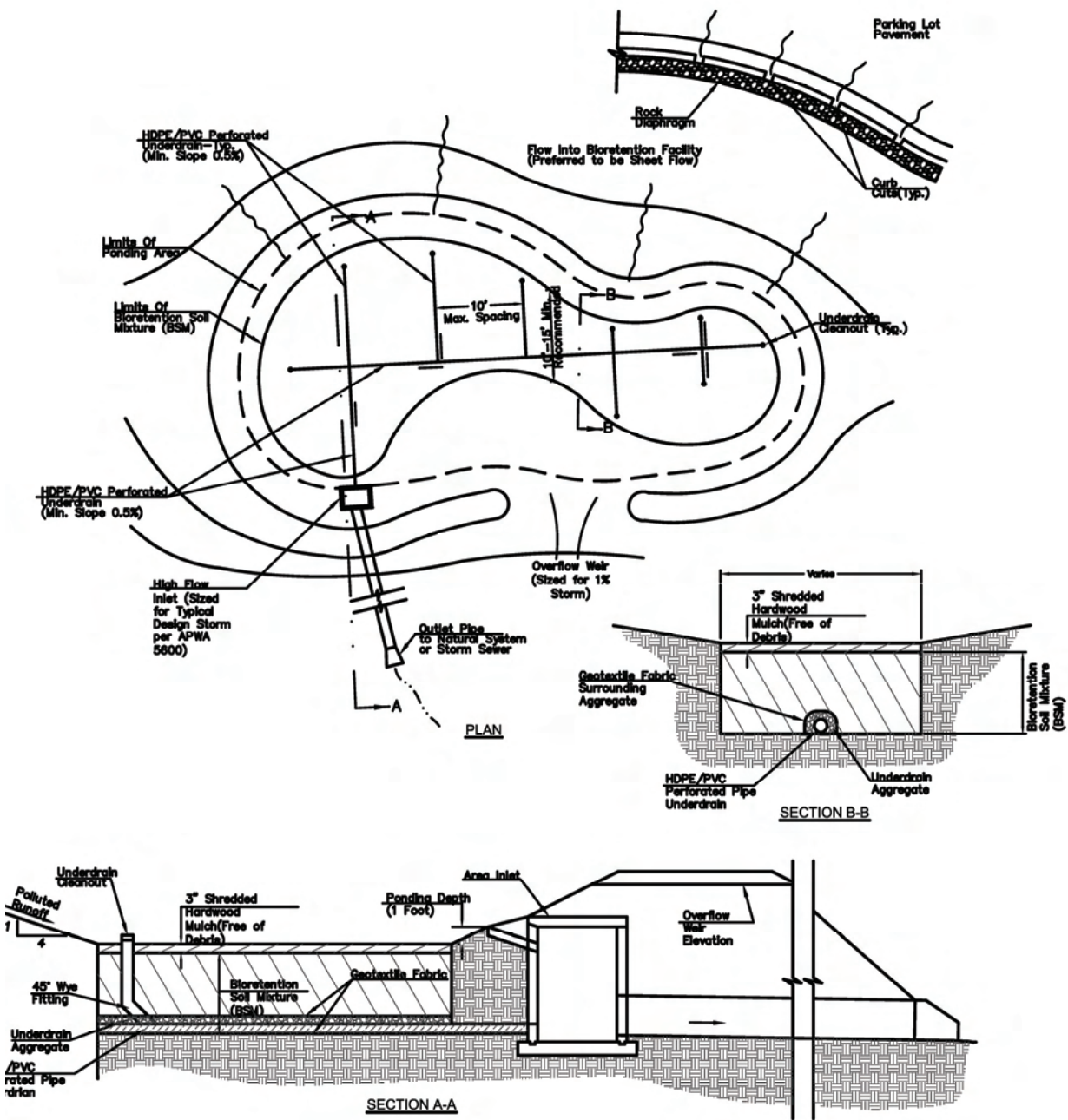

FIGURE 8.5 - Bioretention Plan and Profile

Design Procedure Form: Bioretention
Main Worksheet

Designer: _____
 Checked By: _____
 Company: _____
 Date: _____
 Project: _____
 Location: _____

<u>I. Water Quality Volume</u>	
Step 1) Tributary area to bioretention area, A_T (ac)	A_T (ac) = 0.55
Step 2) Calculate WQv using methodology in Section 6	WQv (cu-ft) = 2380
<u>IIa. Pretreatment</u>	
Step 1) Specify type of inflow to Bioretention facility: Type 1 = sheet flow Type 2 = concentrated or channelized	Inflow type = 1
Step 2) Pretreatment	<u>Vegetated Pretreatment Strip</u>
Step 3) Proceed to Part IIb, IIc, or IId for design guidance on different pretreatment options	
<u>IIb. Vegetated Pretreatment Strip</u>	
Step 1) Type of land cover of contributing area: Type 1 = Impervious (i.e., parking lot) Type 2 = Pervious (i.e., residential lawn)	Land cover type = 1
Step 2) Maximum inflow approach length, L_{approach} (ft)	L_{approach} (ft) = 75
Step 3) Average slope of pretreatment strip, S_{fs} (%) (Maximum slope of 6%)	S_{fs} (%) = 1.5
Step 4) Vegetated pretreatment strip minimum length, L_{fs} (ft), from Table 8.2	L_{fs} (ft) = 20
<u>IIc. Vegetated Pretreatment Channel</u>	
Step 1) Percent imperviousness of contributing area, % imp	% imp = NA
Step 2) Average slope of vegetated channel, S_{vc} (%) (Maximum slope of 6%)	S_{vc} (%) = NA
Step 3) Vegetated pretreatment channel minimum length, L_{vc} (ft), from Table 8.3	L_{vc} (ft) = NA
<u>IId. Other Pretreatment Devices</u>	
<p>Other methods of pretreatment may be utilized upstream of a bioretention facility to settle out suspended solids and reduce runoff velocity. Several proprietary devices are available that will achieve these results. Most such devices install below ground and accept inflow from a piped stormwater management system or from surface sheet flow via drop inlets. These devices should be selected and sized based on site-specific conditions for each project.</p>	

Design Procedure Form: Bioretention
Main Worksheet

Designer: _____
 Checked By: _____
 Company: _____
 Date: _____
 Project: _____
 Location: _____

III. Planting Soil Bed and Ponding Area	
Step 1) Planting bed soil depth, d_f (ft) (d_f should be between 2.5 feet and 4 feet).	d_f (ft) = <u>3</u>
Step 2) Coefficient of permeability for planting soil bed, k (ft/day) (k should be at least 1 ft/day)	k (ft/day) = <u>1.3</u>
Step 3) Maximum ponding depth, h_{max} (ft) (h_{max} should be between 0.25 ft and 1.0 ft).	h_{max} (ft) = <u>1</u>
Step 4) Average height of water above bioretention bed, h_{avg} (ft) $h_{avg} = h_{max}/2$	h_{avg} (ft) = <u>0.5</u>
Step 5) Time required for WQv to filter through the planting soil bed, t_f (days) (t_f of 1 to 3 days is recommended)	t_f (days) = <u>2</u>
Step 6) Required filter bed surface area, A_f (ft ²) $A_f = (WQv * d_f) / [k * t_f * (h_{avg} + d_f)]$	A_f (ft ²) = <u>785</u>
Step 7) Approximate filter bed length, L_f (ft), assuming a length to width ratio of 2:1 (L_f should be at least 40 ft)	L_f (ft) = <u>40</u>
Step 8) Approximate filter bed width, W_f (ft), assuming a length to width ratio of 2:1 (W_f should be at least 15 feet, and optimally half of L_f)	W_f (ft) = <u>20</u>
Step 9) Required Ponding Area, A_p (sf) $A_p = WQv / h_{max}$	A_p (ft ²) = <u>2380</u>

Design Procedure Form: Bioretention
Main Worksheet

Designer: _____
 Checked By: _____
 Company: _____
 Date: _____
 Project: _____
 Location: _____

<u>IV. Underdrain</u>		
Step 1) Underdrain pipe diameter, D_U (in) (D_U should be at least 4 inches)	D_U (in) =	<u>6</u>
Step 2) Depth of gravel blanket, Z_{gravel} (in.) (Z_{gravel} should be at least 8 inches, and at least 2 inches greater than D_U)	Z_{gravel} (in) =	<u>8</u>
Step 3) Set underdrain perforation diameters to 0.375 inches.	D_{perf} (in) =	<u>0.375</u>
Step 4) Longitudinal center-to-center underdrain perforation spacing, S_{perf} (in)	S_{perf} (in) =	<u>6</u>
Step 5) Number of perforations per row (around circumference of underdrain), n_{perf} (n_{perf} should be at least 4)	n_{perf} =	<u>5</u>
Step 6) Are transverse collector pipes required perpendicular to main pipe? (Yes or no) (Yes, if width of bioretention area is greater than 10 feet)		<u>Yes</u>
Step 7) Underdrain transverse collector pipe spacing center-to-center, S_U (ft) (S_U should be a maximum of 10 ft)	S_U (ft) =	<u>N/A</u>
Step 8) Required number of underdrain transverse collector pipes, n_{pipe}	n_{pipe} =	<u>0</u>
Step 9) Pipe grade, G_{pipe} (%), for main pipe and transverse collector pipes (G_{pipe} should be at least 0.5%)	G_{pipe} (%) =	<u>0.5</u>
Step 10) Providing at least one cleanout per pipe run? (Yes or No)		<u>Yes</u>
<u>V. Overflow</u>		
<p>The bioretention overflow shall be designed to safely pass runoff flows from events up to and including the 1 percent event unless the facility is designed with a bypass around the facility for larger storm events. If the 1-percent event is to pass through the facility, the maximum velocity shall be kept below 3 feet per second to avoid erosion of the soil matrix. If facilities are designed with a bypass, it shall be designed to safely pass runoff flows from events up to and including the 1 percent event. The overflow shall be designed as a vegetated or stabilized channel of a yard inlet catch basin. Vegetated or stabilized channels shall be designed using one of the methods presented in APWA Section 5603 and shall conform to the design criteria presented in APWA Section 5607. Methods presented in APWA Section 5604 shall be used for inlet design.</p>		

Design Procedure Form: Bioretention
Main Worksheet

Designer: _____
Checked By: _____
Company: _____
Date: _____
Project: _____
Location: _____

V. Vegetation

Describe mix and density of vegetation to be placed in the bioretention facility. Follow specifications given under Plant Materials in Appendix A. It is beneficial to plant variable types and species of plants in a bioretention facility. Such variability prevents single-species susceptibility to disease and insect infestation and provides a more aesthetic appearance. Native species should be used because they are more likely to thrive in the local climate. A minimum of three native species of shrubs and three native species of trees recommended. Plants should also be selected for their ability to withstand extended dry conditions (which are likely to occur in parking lot island bioretention facilities) and periodic inundation.

**Design Procedure Form: Bioretention
Main Worksheet**

Designer: _____
 Checked By: _____
 Company: _____
 Date: _____
 Project: _____
 Location: _____

<u>I. Water Quality Volume</u>	
Step 1) Tributary area to bioretention area, A_T (ac)	A_T (ac) = _____
Step 2) Calculate WQv using methodology in Section 6	WQv (cu-ft) = _____
<u>IIa. Pretreatment</u>	
Step 1) Specify type of inflow to Bioretention facility: Type 1 = sheet flow Type 2 = concentrated or channelized	Inflow type = _____
Step 2) Pretreatment	_____
Step 3) Proceed to Part IIb, IIc, or IId for design guidance on different pretreatment options	
<u>IIb. Vegetated Pretreatment Strip</u>	
Step 1) Type of land cover of contributing area: Type 1 = Impervious (i.e., parking lot) Type 2 = Pervious (i.e., residential lawn)	Land cover type = _____
Step 2) Maximum inflow approach length, L_{approach} (ft)	L_{approach} (ft) = _____
Step 3) Average slope of pretreatment strip, S_{fs} (%) (Maximum slope of 6%)	S_{fs} (%) = _____
Step 4) Vegetated pretreatment strip minimum length, L_{fs} (ft), from Table 8.2	L_{fs} (ft) = _____
<u>IIc. Vegetated Pretreatment Channel</u>	
Step 1) Percent imperviousness of contributing area, % imp	% imp = _____
Step 2) Average slope of vegetated channel, S_{vc} (%) (Maximum slope of 6%)	S_{vc} (%) = _____
Step 3) Vegetated pretreatment channel minimum length, L_{vc} (ft), from Table 8.3	L_{vc} (ft) = _____
<u>IId. Other Pretreatment Devices</u>	
<p>Other methods of pretreatment may be utilized upstream of a bioretention facility to settle out suspended solids and reduce runoff velocity. Several proprietary devices are available that will achieve these results. Most such devices install below ground and accept inflow from a piped stormwater management system or from surface sheet flow via drop inlets. These devices should be selected and sized based on site-specific conditions for each project.</p>	

**Design Procedure Form: Bioretention
Main Worksheet**

Designer: _____
 Checked By: _____
 Company: _____
 Date: _____
 Project: _____
 Location: _____

III. Planting Soil Bed and Ponding Area	
Step 1) Planting bed soil depth, d_f (ft) (d_f should be between 2.5 feet and 4 feet).	d_f (ft) = _____
Step 2) Coefficient of permeability for planting soil bed, k (ft/day) (k should be at least 1 ft/ day)	k (ft/ day) = _____
Step 3) Maximum ponding depth, h_{max} (ft) (h_{max} should be between 0.25 ft and 1.0 ft).	h_{max} (ft) = _____
Step 4) Average height of water above bioretention bed, h_{avg} (ft) $h_{avg} = h_{max}/2$	h_{avg} (ft) = _____
Step 5) Time required for WQv to filter through the planting soil bed, t_f (days) (t_f of 1 to 3 days is recommended)	t_f (days) = _____
Step 6) Required filter bed surface area, A_f (ft ²) $A_f = (WQv \cdot d_f) / [k \cdot t_f \cdot (h_{avg} + d_f)]$	A_f (ft ²) = _____
Step 7) Approximate filter bed length, L_f (ft), assuming a length to width ratio of 2:1 (L_f should be at least 40 ft)	L_f (ft) = _____
Step 8) Approximate filter bed width, W_f (ft), assuming a length to width ratio of 2:1 (W_f should be at least 15 feet, and optimally half of L_f)	W_f (ft) = _____
Step 9) Required Ponding Area, A_p (sf) $A_p = WQv / h_{max}$	A_p (ft ²) = _____

**Design Procedure Form: Bioretention
Main Worksheet**

Designer: _____
 Checked By: _____
 Company: _____
 Date: _____
 Project: _____
 Location: _____

<u>IV. Underdrain</u>	
Step 1) Underdrain pipe diameter, D_U (in) (D_U should be at least 4 inches)	D_U (in) = _____
Step 2) Depth of gravel blanket, Z_{gravel} (in.) (Z_{gravel} should be at least 8 inches, and at least 2 inches greater than D_U)	Z_{gravel} (in) = _____
Step 3) Set underdrain perforation diameters to 0.375 inches.	D_{perf} (in) = _____
Step 4) Longitudinal center-to-center underdrain perforation spacing, S_{perf} (in)	S_{perf} (in) = _____
Step 5) Number of perforations per row (around circumference of underdrain), n_{perf} (n_{perf} should be at least 4)	n_{perf} = _____
Step 6) Are transverse collector pipes required perpendicular to main pipe? (Yes or no) (Yes, if width of bioretention area is greater than 10 feet)	_____
Step 7) Underdrain transverse collector pipe spacing center-to-center, S_U (ft) (S_U should be a maximum of 10 ft)	S_U (ft) = _____
Step 8) Required number of underdrain transverse collector pipes, n_{pipe}	n_{pipe} = _____
Step 9) Pipe grade, G_{pipe} (%), for main pipe and transverse collector pipes (G_{pipe} should be at least 0.5%)	G_{pipe} (%) = _____
Step 10) Providing at least one cleanout per pipe run? (Yes or No)	
<u>V. Overflow</u>	
<p>The bioretention overflow shall be designed to safely pass runoff flows from events up to and including the 1 percent event unless the facility is designed with a bypass around the facility for larger storm events. If the 1-percent event is to pass through the facility, the maximum velocity shall be kept below 3 feet per second to avoid erosion of the soil matrix. If facilities are designed with a bypass, it shall be designed to safely pass runoff flows from events up to and including the 1 percent event. The overflow shall be designed as a vegetated or stabilized channel of a yard inlet catch basin. Vegetated or stabilized channels shall be designed using one of the methods presented in APWA Section 5603 and shall conform to the design criteria presented in APWA Section 5607. Methods presented in APWA Section 5604 shall be used for inlet design.</p>	

Design Procedure Form: Bioretention
Main Worksheet

Designer: _____
Checked By: _____
Company: _____
Date: _____
Project: _____
Location: _____

V. Vegetation

Describe mix and density of vegetation to be placed in the bioretention facility. Follow specifications given under Plant Materials in Appendix A. It is beneficial to plant variable types and species of plants in a bioretention facility. Such variability prevents single-species susceptibility to disease and insect infestation and provides a more aesthetic appearance. Native species should be used because they are more likely to thrive in the local climate. A minimum of three native species of shrubs and three native species of trees recommended. Plants should also be selected for their ability to withstand extended dry conditions (which are likely to occur in parking lot island bioretention facilities) and periodic inundation.

Variable Dictionary

<u>Variable</u>	<u>Units</u>	<u>Definition</u>
A_f	ft ²	Required filter bed surface area
A_T	ac	Tributary area to Bioretention Facility
d_f	ft	Planting bed soil depth
D_{perf}	in	Underdrain perforation diameter
D_U	in	Underdrain pipe diameter
G_{pipe}	%	Pipe grade for main pipe and transverse collector pipes
h_{avg}	ft	Average ponding depth above soil bed
h_{max}	ft	Maximum ponding depth above soil bed
k	ft/day	Coefficient of permeability for planting soil bed
$L_{approach}$	ft	maximum inflow approach length to bioretention facility
L_f	ft	Approximate filter bed length
L_{fs}	ft	Minimum length of vegetated filter strip
L_{vc}	ft	Minimum length of vegetated channel
n_{perf}	none	Number of perforations per row (around circumference of underdrain pipe)
n_{pipe}	none	Number of underdrain transverse collector pipes
% Imp	%	Percent imperviousness of contributing area
S_{fs}	%	Average slope of vegetated filter strip
S_{perf}	in	Longitudinal center-to-center underdrain perforation spacing
S_U	ft	Underdrain transverse collector pipe spacing, center-to-center
S_{vc}	%	Average slope of vegetated channel
t_f	days	Time required for the WQv to filter through the planting soil bed
W_f	ft	Approximate filter bed width
WQv	ac-ft	Water quality volume
Z_{gravel}	in	Depth of gravel blanket

Part IIIb, Step 6) Required filter bed surface area equation derivation

$$WQv = Q * t \quad \text{(Volume = Flow Rate * Time)}$$

$$Q = k * i * A \quad \text{(Darcy's Law)}$$

$$WQv = k * i * A * t \quad \text{(Substitute in Darcy parameters for Q)}$$

$$i = \Delta h/H = (h_{avg} + d_f)/d_f \quad \text{(Darcy hydraulic gradient)}$$

$$WQv = k * [(h_{avg} + d_f)/d_f] * A_f * t_f \quad \text{(Substitute in hydraulic gradient terms)}$$

$$A_f = (WQv * d_f) / [k * t_f * (h_{avg} + d_f)] \quad \text{(Rewrite to solve for } A_f \text{)}$$

WQv = water quality volume in (ac-ft)

d_f = planting bed soil depth in (ft)

k = coefficient of permeability for planting soil bed in (ft/day)

t_f = time required for WQv to filter through the planting soil bed in (days)

h_{avg} = average ponding depth above planting soil bed in (ft)

8.5 PERMEABLE PAVEMENT



Modular Pavers



Concrete Grids



Pervious Concrete



Porous Asphalt

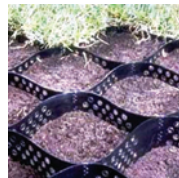

Cellular Confinement Systems

Targeted Constituents

Sediment	○
Nutrients	○
Trash	○
Metals	◐
Bacteria	◐
Oil and Grease	●
Organics	○

Legend (Removal Effectiveness)

High	Medium	Low
●	◐	○

8.5.1 Description

Permeable pavements reduce stormwater runoff and its associated pollutants by conveying stormwater through a pavement surface, providing storage, and promoting in-situ stormwater infiltration. They convey and treat stormwater runoff through a “system”, which at a minimum includes the permeable pavement and the underlying soils. This system may also include a retention/detention zone (aggregate base), a filter material (sand/filter fabric), and an underdrain or overflow system.

The structure of permeable pavements are primarily designed to function as both an outlet for stormwater runoff and a surface to transport and store vehicular traffic. Permeable pavements include but are not limited to *pervious concrete*, *porous asphalt*, and *proprietary pavement systems*.

Pervious concrete is a mixture of Portland cement, coarse aggregate, water, and admixtures. It contains little or no sand, and is sometimes referred to as “no-fines” concrete. Only enough Portland cement and water is added to the mixture to glue the aggregate together while providing void spaces for the water to percolate through.

Porous asphalt is a bituminous paving mixture of asphalt cement, coarse aggregate, and admixtures. It contains little or no sand. Only enough asphalt cement is added to the mixture to glue the aggregate together while providing void spaces for the water to percolate through.

For both pervious concrete and porous asphalt, there is a uniformly graded, clean, crushed stone aggregate base beneath the pavement. Stormwater drains through the pavement layer, is stored in the aggregate base, and infiltrates slowly into the underlying soil. A layer of non-woven geotextile filter fabric separates the stone bed from the underlying soil, which prevents the migration of fine soil particles into the aggregate base. The subsurface stone bed serves as either a storage/infiltration structure, or a simple subsurface detention basin, depending on site conditions.

Other than pervious concrete and porous asphalt, there are many different proprietary pavement systems available. For the purposes of this manual, three primary types are discussed.

- Modular Pavers – Consist of pavers that may be clay bricks, granite sets, or pre-cast concrete of various shapes. They are installed on a uniformly graded, clean, crushed stone aggregate base with permeable

material placed in the gaps between the units. These impervious monolithic units convey the stormwater to the perimeter of each paver, where it is then transferred through the permeable material in the gaps to the aggregate base.

- Pre-Cast Concrete Grids – Concrete grid paving units consist of an impervious concrete grid structure that is filled with aggregate or soil, in which vegetation may be established. They are typically pre-cast at a concrete plant and shipped to the job site for placement. There are two major types of concrete grids.
 - ◇ *Lattice Pavers* – Include a flat surface that forms a continuous pattern of concrete when installed
 - ◇ *Castellated Pavers* – Include protruding concrete knobs on the surface making the grass appear continuous when installed.

Concrete grid pavers range in weight from 45 to 90 pounds and provide approximately 20 to 50 percent pervious area.

- Cellular Confinement Systems – Consists of a plastic grid that is filled with aggregate or soil. Vegetation may be planted within the cells.

8.5.2 General Application

Permeable pavement has been used across the U.S. in a variety of applications. They are primarily suitable for low-traffic areas such as driveways, parking areas, storage yards, bike paths, walkways, recreational vehicle pads, service roads, and fire lanes.

Permeable pavements are designed primarily for stormwater quality, i.e. the removal of stormwater pollutants. However, they can provide limited runoff quantity control, particularly for smaller storm events. Permeable pavements may be used in conjunction with other BMPs in order to provide a higher level of quantity control, if desired.

The permeable pavement system should be designed to receive stormwater runoff from the pavement during the water quality rainfall event as well as inflow from other impervious areas such as rooftops and driveways.

To protect groundwater from potential contamination, runoff from designated hotspot land uses or high concentrations of soluble pollutants should not be infiltrated.

8.5.3 Advantages

- Allows for reduction of standard stormwater infrastructure such as piping, catch basins, retention ponds, curbing, etc.
- May have a lower cost when considered against traditional pavement and stormwater management techniques
- Provides quantity control for small rainfall events, and reduces water into CSO systems
- Provides water quality treatment benefit
- Recharges groundwater
- Suitable for cold climate applications, maintains recharge capacity when ambient temperatures are below freezing
- Has the potential to reduce the occurrence of black ice
- Reduces the need for sand and salt use
- The life of pavement is extended due to a well drained base and reduced freeze-thaw cycles within the pavement
- Maintains traction when wet

-
- Reduces spray from traveling vehicles
 - Reduces roadway noise

8.5.4 Disadvantages

- May cost more than traditional paving
- Can require high cost for restorative maintenance when not properly maintained
- Requires routine maintenance (annual or semi-annual depending upon site conditions)
- Proper construction stabilization and erosion control are required to prevent clogging
- Quality control for material production and installation are essential for success
- Accidental seal coating or similar surface treatment will cause failure
- Special care required for plows during snow removal, especially with pavers

8.5.5 Physical Site Suitability

8.5.5.1 Soils

The on-site soil conditions are critical to the design and performance of permeable pavement systems. A professional engineer knowledgeable in the local soils should provide soil sub-grade sampling and analysis. Soil testing should at a minimum include soil classification, moisture content, in-situ infiltration tests, and verification that the location of bedrock and the seasonal high groundwater table are not closer than three feet from the sub-grade.

8.5.5.2 Tributary Area

Where impermeable surfaces are proposed to drain onto the permeable pavement, it is recommended that the impermeable surfaces make up no more than two-thirds of the total area.

If runoff is coming from adjacent permeable areas (such as grass lots), the travel distance of the runoff should not be more than 100 feet before it is intercepted by permeable pavement and should remain sheet flow. It is important that the permeable areas be fully stabilized to reduce sediment loads and prevent clogging of the permeable pavement system. Pretreatment using filter strips or vegetated swales for removal of coarse sediments is recommended and may reduce maintenance frequency.

Sediment laden runoff from construction sites should not be allowed to drain onto permeable pavements. This is one of the leading causes of failure for infiltration BMPs.

8.5.5.3 Slopes

If the pavement sub-grade is not level, the upper portion of the pavement system will not be filled and the rainfall will quickly run to the lowest point of the system. Once the lower portion is filled, the rain will run out of the lower end of the pavement rapidly due to the high permeability of the pavement. In order to make the sub-grade level, the depth of the aggregate base should be increased on the high end of the system. Terraces or intermittent check dams may also be used to increase the storage volume on larger sites. (Hydrologic Design of Pervious Concrete, Portland Cement Association, 2007)

8.5.6 Pollutant Removal Capability

As they provide for the infiltration of stormwater runoff, permeable pavement systems have a high removal of both soluble and fine particulate pollutants, where they become trapped, absorbed or broken down in the underlying soil layers. Due to the potential for clogging, permeable pavement surfaces should not be used for the removal of sediment or other coarse particulate pollutants.

Information about the performance and removal efficiencies of permeable pavements and other BMPs can be found through the Environmental Protection Agency's Urban BMP Performance Tool website (<http://cfpub.epa.gov/npdes/stormwater/urbanbmp/bmpeffectiveness.cfm>).

8.5.7 Design and Construction Guidelines

8.5.7.1 *Pervious Concrete*

- 15-25% voids are typical for pervious concrete.
- A roller screed should be used and the concrete should be immediately covered with plastic.
- Pavement should be jointed to control cracking.
- Fibers and 6 to 7% sand should be added to the mixture to promote higher strength.
- Freeze-thaw is not an issue if the correct mix design is used.
- Contractor certification is extremely important to ensure proper installation of pervious concrete. A Certification for Pervious Concrete Contractors and Ready Mixed Concrete Producers is available through The Concrete Promotional Group and the Missouri/Kansas Chapter of the American Concrete Pavement Association. (www.concretepromotion.com)

8.5.7.2 *Porous Asphalt*

- 15-25% voids are typical for porous asphalt.
- A single-size crushed aggregate (1/2-inch) choker layer should be used to stabilize the surface of the aggregate base for paving.
- The National Asphalt Pavement Association (NAPA) does not have a certification process for installing porous asphalt.
- A thickened edge or ribbon curb should be installed at the interface of standard asphalt and permeable pavements.

8.5.7.3 *Proprietary Pavement Systems*

- Proprietary pavement systems should be selected and designed based on manufacturer's tests that show the installed unit paving system maintain a minimum of 1.1 in/hr infiltration rate over the pavement life, with a minimum initial infiltration rate of 11 in/hr. (Stormwater Source Control Design Guidelines 2005, Greater Vancouver Sewerage & Drainage District)
- It is recommended that proprietary pavement systems provide edge restraint to contain the pavers, similar to standard unit paving.
- Vegetated systems should not be used in heavily shaded areas, such as under long term parking, due to maintenance issues.
- An appropriate modular porous paver should be selected for the intended application. A minimum of 40% of the surface area should consist of open void space. If it is a load bearing surface, then the pavers should be designed to support the maximum load. (2001 Georgia Stormwater Manual, Volume 2, Chapter 3.3.8, Modular Porous Paver Systems)
- The porous paver infill is selected based upon the intended application and required infiltration rate. Masonry sand (such as ASTM C-33 concrete sand) has a high infiltration rate (8 in/hr) and should be used in applications where no vegetation is desired. A sandy loam soil has a substantially lower infiltration rate (1 in/hr), but will provide for growth of a grass ground cover. (2001 Georgia Stormwater Manual)

-
- A 1-inch top course (filter layer) of sand (ASTM C-33 concrete sand) underlain by filter fabric should be placed under the porous pavers and above the gravel base course. (2001 Georgia Stormwater Manual)

8.5.7.4 *All Permeable Pavement Systems*

- 36-42% voids are typical for the aggregate base, which is compacted at 95% proctor (use 36% voids if no data is available).
- ¾-inch clean (<2% passing #200 sieve) crushed aggregate should be used for the base.
- A minimum thickness of 12 inches should be used for the aggregate base.
- Disturbance of the sub-grade should be minimized during construction to reduce compaction and promote infiltration into the sub-soil.
- For drawdown design purposes, use 0.5 in/day of perceived infiltration/evaporation unless on-site soil permeability testing shows a higher infiltration rate.
- A non-woven geotextile fabric should be placed between the aggregate base and the subsoil to prevent the migration of fine grained soils into the aggregate base.
- Standard pavements should be used in areas of heavy truck traffic and high turning frequency due to the tendency of permeable pavements to ravel and deteriorate under high turning loads.
- Permeable pavement system designs must use some method to convey larger storm event flows to the conveyance system.
- Off-site test placements for the contractor and supplier are recommended to ensure quality, especially for first time or non-certified installers. Typically, a 10'x30' test strip is adequate.

8.5.7.5 *Overflow Conveyance within the Aggregate Base:*

- The aggregate base should contain an overflow conveyance system (typically perforated pipe) set at the water quality volume elevation. Volumes greater than the water quality volume will pass through the overflow conveyance and into a BMP treatment train or the storm sewer system.
- The underdrain should be designed so that the travel distance of the stormwater is no greater than 100 feet after it enters into the aggregate base.
- An inspection well may be installed in order to monitor the sub-base and the drawdown time.
- A minimum of 3 inches of cover between the perforated pipe and the bottom of the pavement should be provided. Additionally, the installation must meet the minimum cover requirements of the pipe manufacturer.

8.5.8 **Maintenance and Inspections**

- Cast-in-place installations can be snowplowed. Additional care is needed when plowing paving blocks or grids. Signs should be posted so that plow operators are made aware of the permeable pavement surface.
- Limit fertilizers and deicing chemicals since they will flow directly into the stormwater and groundwater.
- Salt should not be used during the first winter on concrete applications.
- Provide maintenance when the surface becomes visibly clogged or when standing water is observed on the pavement during a typical storm event.
- Semi-annual routine maintenance can be performed by a street sweeper or landscape vacuum equipment.
- Sections that have become plugged should be cleaned by a combination of pressure washing and vacuuming the liberated debris.

- Long-term maintenance is necessary to ensure proper performance.
- Inspect on a yearly basis for sediment loading.

8.5.9 Design Example

8.5.9.1 Data

A 1.5-acre overflow parking area is to be designed to provide water quality treatment for the water quality storm event (1.37 inches) using pervious concrete. Initial data shows:

- Borings show depth to water table from finished grade is 5.0 feet.
- Boring and infiltrometer tests show silty-clay with a permeability (k) of 0.018 inch/hr.
- Structural design indicates the thickness of the porous concrete must be at least 6 inches.
- A porosity of 0.36 was determined for the gravel.

8.5.9.2 Water Quality Volume (WQv)

$$R_v = 0.05 + 0.009 I \text{ (where } I = 100 \text{ percent)}$$

$$= 0.95$$

$$WQv = P * R_v * A / 12 = 1.37\text{in} * 0.95 * 1.5\text{ac} / 12\text{in/ft}$$

$$= 0.1627\text{ac-ft} = 7,087 \text{ ft}^3$$

8.5.9.3 Thickness of Aggregate Base

The minimum depth of gravel (D_g) required below the overflow conveyance system can be calculated as:

$$D_g = (WQv * 12\text{in/ft}) / (A * 43,560\text{ac/ft}^2 * n) \text{ Where, } WQv = \text{Water Quality Volume (ft}^3)$$

A = Drainage Area (ac)

n = Porosity of Aggregate

$$D_g = (7,087\text{ft}^3 * 12\text{in/ft}) / (1.5\text{ac} * 43,560\text{ac/ft}^2 * 0.36) = 3.62 \text{ in}$$

Using a 4-inch perforated pipe for the overflow system, and providing a minimum 3 inches cover between the perforated pipe and the bottom of pavement gives a total aggregate depth of 10.62 inches (use 12-inch minimum).

8.5.10 Drain Time

The minimum infiltration/evaporation rate of 0.50 inches/day (-0.0208 inches/hour) should be used since testing showed an infiltration rate of 0.018 inch/hr (0.43 inch/day).

$$\text{Drawdown Time} = P / k$$

Where

P = Water Quality Rainfall Depth (in)

k = soil permeability (in/day)

$$\text{Drawdown Time} = 1.37\text{in} / 0.50\text{in/day} = 2.6 \text{ days}$$

8.6 EXTENDED DETENTION WETLAND

8.6.1 Description



Source: Applied Ecological Services

Targeted Constituents

Sediment	●
Nutrients	●
Trash	◐
Metals	●
Bacteria	●
Oil and Grease	◐
Organics	●

Legend (Removal Effectiveness)

High	Medium	Low
●	◐	○

Source: California Stormwater Quality Association, *California Stormwater Quality Association Stormwater Best Management Practice Handbook*, 2003

An extended detention wetland (EDW) is a constructed basin that has a permanent pool of water throughout the growing season and captures the water quality volume (WQv) and releases it over a 40-hour period. An EDW differs from an extended wet detention basin (EWDB) primarily in being shallower (approximately 18 inches maximum depth in an EDW main pool versus 6 to 12 feet maximum depth in a EWDB main pool). EDWs are among the most effective stormwater practices in terms of pollutant removal, and they also offer aesthetic value. As stormwater runoff flows through the wetland, pollutant removal is achieved through settling and biological uptake within the wetland. Flow through the root systems allows the vegetation to remove nutrients and dissolved pollutants from the stormwater (California Stormwater Quality Association, 2003). A temporary detention volume is provided above the permanent pool to capture the WQv and enhance sedimentation (Urban Drainage and Flood Control District, Denver, Colorado, 2005).

A distinction should be made between using a constructed wetland for stormwater management and diverting stormwater into a natural wetland. The latter practice is not recommended, and in all circumstances natural wetlands should be protected from the adverse effects of development, including impacts from increased stormwater runoff. This is especially important because natural wetlands provide stormwater and flood control benefits on a regional scale (California Stormwater Quality Association, 2003).

The EDW combines the treatment concepts of the extended dry detention basin (EDDB) and the constructed wetland. In this design, the WQv is detained above the permanent pool and released over 40 hours.

8.6.2 General Application

Because EDWs are generally shallower than EWDBs, an EDW will require a greater surface area to treat the same volume of runoff as an EWDB. For this reason, EDWs are well suited to treat runoff from large industrial and commercial project sites with ample space (City of Knoxville, 2001). When siting an EDW, it is beneficial to select a site with loamy soils for the wetland bottom to permit plants to take root and to design the normal water level to be near the wet season groundwater table. Wetland basins also require a near-zero longitudinal slope to slow the velocity of flow through them, which can be provided using embankments (Urban Drainage and Flood Control District, Denver, Colorado, 2005).

Besides pollutant removal, an EDW offers several potential advantages such as natural aesthetic qualities, wildlife habitat, erosion control, and recreational benefits such as walking paths and bird watching. It can also provide an

effective follow-up treatment to onsite and source control best management practices (BMPs) that rely upon settling of larger sediment particles (Urban Drainage and Flood Control District, Denver, Colorado, 2005).

8.6.3 Advantages

- Because of the presence of the permanent wet pool with a normal residence time of at least 14 days, properly designed and maintained EDWs can provide significant water quality improvement across a relatively broad spectrum of constituents, including dissolved nutrients and many urban pollutants (California Stormwater Quality Association, 2003) (Urban Drainage and Flood Control District, Denver, Colorado, 2005).
- Widespread application of EDWs with sufficient capture volume can provide significant control of channel erosion and enlargement caused by changes to flow frequency relationships resulting from the increase of impervious cover in a watershed (California Stormwater Quality Association, 2003).
- May provide groundwater recharge – a particular advantage during periods of drought.
- Protects downstream water bodies.
- If properly designed, constructed, and maintained, EDWs can provide substantial aesthetic/recreational value and wildlife and wetlands habitat (California Stormwater Quality Association, 2003).

8.6.4 Disadvantages

- An EDW requires a relatively large footprint (California Stormwater Quality Association, 2003).
- The public can sometimes view EDWs as a safety concern when they are constructed where there is public access (California Stormwater Quality Association, 2003).
- EDW facilities may not be feasible in some locations because of insufficient tributary area to maintain the permanent pool (California Stormwater Quality Association, 2003) (Urban Drainage and Flood Control District, Denver, Colorado, 2005) (City of Knoxville, 2001).
- An EDW cannot be placed on steep unstable slopes (California Stormwater Quality Association, 2003) (Metropolitan Nashville – Davidson County, 2000).
- Overgrowth of vegetation can lead to reduced storage volume, and thus frequent monitoring is required to remove nuisance vegetation and animals (Metropolitan Nashville – Davidson County, 2000) (City of Knoxville, 2001).
- Rarely feasible in densely developed areas (Metropolitan Nashville – Davidson County, 2000).

8.6.5 Design Requirements and Considerations

The following guidelines are to be considered when designing EDWs:

- To ensure that wetland vegetation can be sustained, a water budget shall be performed for the EDW. Refer to Chapter 13 of the NRCS *Engineering Field Handbook* for techniques on calculating water budgets. (Natural Resources Conservation Service, 1997).
- Provide outlet works that limit the WQv maximum depth to 2 feet or less. If flood control volume is provided, the depth of the flood control volume can be allowed to reach a maximum of 2 feet above the WQv for up to 12 hours. See APWA 5600 for design specifications if flood control is to be incorporated into the design of the EWDB.
- The basin should be sized to hold the permanent pool as well as the required WQv. The outlet shall be designed to discharge the WQv over a period of 40 hours (California Stormwater Quality Association, 2003) (Urban Drainage and Flood Control District, Denver, Colorado, 2005). When computer software is used to

size the water quality outlet, a drawdown of 40 hours is reached when at least 90 percent of the WQv has exited the basin within 40 hours.

- The permanent pool should be configured as a two-stage facility with a sediment forebay and a main pool. The facility should be wedge-shaped, narrowest at the inlet and widest at the outlet (California Stormwater Quality Association, 2003).
- Side slopes of the basin should be 4:1 (H:V) or flatter for grass stabilized slopes. Slopes steeper than 4:1 should be stabilized with an appropriate slope stabilization practice (California Stormwater Quality Association, 2003) (Metropolitan Nashville – Davidson County, 2000).
- A sediment forebay shall be incorporated into the design to decrease velocity and sediment loading to the wetland. The sediment forebay should be separated from the wetland by an earthen berm, gabion, or loose riprap wall. The forebay shall be at least 10 percent of the WQv and shall be 4 feet to 6 feet deep. The forebay should be able to contain at least 5 years of sediment expected from the watershed. The use of a sediment forebay can extend the sediment removal interval from the permanent pool by 150 percent (Naval Facilities Engineering Service Center, 2004). The forebay consists of a separate cell formed by an acceptable barrier such as a vegetated earthen weir, gabion, or loose riprap wall (California Stormwater Quality Association, 2003). To make sediment removal easier, the bottom and side slopes of the forebay may be lined with concrete (Urban Drainage and Flood Control District, Denver, Colorado, 2005). Direct maintenance access shall be provided to the forebay.
- A separate drain pipe with a manual valve that can completely drain the wetland for maintenance purposes is recommended. To allow for possible sediment accumulation, the submerged end of the pipe shall be protected, and the drain pipe shall be sized to drain the pond within 24 hours (California Stormwater Quality Association, 2003). The valve shall be located at a point where it can be operated in a safe and convenient manner at all times. Complete gravity drawdown may be impossible for excavated wetlands, and a pump may be required to drain the permanent pool.
- Incorporate a 4-foot to 6-foot deep micropool (a capacity at least 10 percent of total WQv) before the outlet to prevent outlet clogging. A reverse slope pipe or a hooded, broad-crested weir is the recommended outlet control (Urban Drainage and Flood Control District, Denver, Colorado, 2005) (Kansas City Metropolitan Chapter of the American Public Works Administration, 2006). Locate the outlet from the micropool at least 1 foot below the normal pool surface. To prevent clogging, install trash racks, well screen, or hoods on the riser. Size the rack so as not to interfere with the hydraulic capacity of the outlet (Urban Drainage and Flood Control District, Denver, Colorado, 2005). To facilitate access for maintenance, install the riser within the embankment.
- Place aboveground berms or high marsh wedges at about 50-foot intervals and at right angles to the direction of the flow to increase the dry-weather flow path within the wetland. The flow path through the wetland should be at least 3 times the width of the facility, as measured across the center of the facility in the smallest dimension at the permanent pool elevation (Metropolitan Nashville – Davidson County, 2000).
- Surround all deep micropools with a safety bench of minimum width 12 feet, slope no steeper than 6:1, and depth of 0 to 24 inches below the pool's normal water level.
- It may be beneficial to incorporate cascades into the wetland layout, possibly by having more than one water surface elevation, or placing a cascade on one fork of a flow path and not on another. A cascade provides aeration and increases oxygen levels in the water. Oxygen is needed for the digestion of organic nutrients and particles in the water (City of Knoxville, 2001).
- Energy dissipation shall be included in the inlet design to reduce resuspension of accumulated sediment (California Stormwater Quality Association, 2003).

-
- Effective wetland design displays “complex microtopography.” In other words, wetlands should have zones of both very shallow (<6 inches) and moderately shallow (<18 inches) depths incorporated, using underwater earth berms to create the zones. This design will provide a longer flow path through the wetland to encourage settling and plant diversity (California Stormwater Quality Association, 2003).
 - The soil must be suitable for wetland vegetation. Hydric soils (soils that are normally saturated) are preferable and can be identified by wetland experts using color and texture. The soil must have an affinity for phosphorous, for which minerals containing aluminum and iron ions are typically desirable (City of Knoxville, 2001).
 - One concern about the long-term performance of wetlands is associated with the vegetation density. If vegetation covers the majority of the facility, open water is confined to a few well-defined channels. This can limit mixing of the stormwater runoff with the permanent pool and reduce the effectiveness as compared to a wet pond where a majority of the area is open water. Thus, wetland vegetation should occupy between 50 and 75 percent of the surface area. Wetland vegetation should be placed along the high and low marshes of the permanent pool. The planting scheme shall be designed to result in high Manning’s n values in the marshes (0.2 to 1.0) to slow the velocity of flow through the wetland and increase residence time.
 - Wetland vegetation species should be selected based upon stress tolerance and hardiness to seasonal variations in water availability (City of Knoxville, 2001). Refer to suggestions and guidelines in **Appendix A** for vegetation selection and planting design.
 - The design should include a buffer to separate the wetland from surrounding land. An average buffer width of 25 feet from the maximum WQv limit is required, with a minimum buffer width of 10 feet. Leaving trees undisturbed in the buffer zone minimizes the disruption of wildlife and reduces opportunity for nuisance vegetation to invade.
 - It is beneficial to provide wildlife habitats within and around a constructed wetland.
 - Standing water throughout the growing season is required to sustain wetland vegetation.
 - Dams that are greater than 10 feet in height but do not fall into state or federal requirement categories shall be designed in accordance with the latest edition of SCS Technical Release No. 60, *Earth Dams and Reservoirs*, as Class C structures (Kansas City Metropolitan Chapter of the American Public Works Administration, 2006).
 - A maintenance ramp and perimeter access shall be included in the design to facilitate access to the basin for maintenance activities (California Stormwater Quality Association, 2003). A 15-foot-wide access strip, with slopes less than 5:1 (H:V) shall be provided around the perimeter of the facility, unless it can be demonstrated that all points of the facility can be maintained with less access provided. The property owner shall also maintain a minimum 15-foot-wide access route to the facility from a street or parking lot (Kansas City Metropolitan Chapter of the American Public Works Administration, 2006).
 - EDWs shall be designed so that runoff flows from storm events greater than the water quality event, up to and including the 1 percent event, safely pass through or around the facility. At a minimum, all facility embankments shall be protected from failure during the 1 percent event.
 - Outflow structures shall be protected by trash racks, well screens, grates, stone filters, submerged inlet pipes to the outflow structure, or other approved devices to ensure that the outlet works will remain functional (Kansas City Metropolitan Chapter of the American Public Works Administration, 2006). A reverse-slope pipe can be used to prevent outlet clogging from debris. A reverse-slope pipe draws from below the permanent pool extending in a reverse angle up to the riser and establishes the water elevation of the permanent pool. Because these outlets draw water from below the level of the permanent pool, they are less likely to be clogged by floating debris (California Stormwater Quality Association, 2003) (Kansas City Metropolitan Chapter of the American Public Works Administration, 2006).

-
- No single outlet orifice shall be less than 4 inches in diameter (smaller orifices are more susceptible to clogging) (California Stormwater Quality Association, 2003). If the calculated orifice diameter necessary to achieve a 40-hour drawdown is less than 4 inches, a perforated riser, orifice plate, or v-notch weir shall be used instead of a single orifice outlet. Keep perforations larger than 1 inch when using orifice plates or perforated risers. Smaller orifice sizes may be used if the weir plate is placed in a riser manhole in a sump-like condition.
 - All pipes through material subject to saturation within earth embankments, regardless of their designated purposes, shall be fitted with watertight cutoff collars or other accepted means of controlling seepage. Such collars shall be of sufficient size and number so as to increase the length of the seepage path along the pipe by at least 15 percent. Spacing between collars shall be 20 to 25 feet. When a single collar is to be used, it shall be placed on the pipe near the point where the centerline of the dam intersects the pipe. If two or more collars are to be installed, they shall generally be placed within the middle third of the pipe length. Generally, such collars should project a minimum of 2 feet beyond the outside of the pipe, regardless of pipe size, and should be no closer than 2 feet to a field joint (Kansas State Board of Agriculture, Division of Water Resources, 1986).
 - The EDW shall be planted with wetland species suitable for design water depths. Local nurseries and the Agricultural Extension Office are good sources of information for plant species and densities. **Appendix A** of this manual provides information on wetland plant species.

8.6.6 Maintenance and Inspections

Routine harvesting of vegetation may increase nutrient removal and prevent the export of these constituents from dead and dying plants falling in the water. Vegetation harvesting in the summer is recommended annually (California Stormwater Quality Association, 2003).

Typical activities and frequencies include:

- Inspect the facility semiannually for burrows, sediment accumulation, structural integrity of the outlet, and litter accumulation (California Stormwater Quality Association, 2003). The banks of the EDW should be checked and areas of erosion repaired. Remove sediments if they are within 18 inches of an outlet opening (Metropolitan Nashville – Davidson County, 2000).
- Areas of erosion shall be evaluated and stabilized (Metropolitan Nashville – Davidson County, 2000) (City of Knoxville, 2001). Repair control structure as needed.
- Maintain emergent and perimeter shoreline vegetation as well as site and road access to facilitate monitoring and maintenance (California Stormwater Quality Association, 2003). Remove nuisance vegetation and animals if present (Metropolitan Nashville – Davidson County, 2000) (City of Knoxville, 2001).
- The side slopes shall conform as closely as possible to regraded or natural land contour, and shall not exceed 4:1 (H:V). Slopes showing excessive erosion may require erosion control and safety measures (Kansas City Metropolitan Chapter of the American Public Works Administration, 2006).
- Remove accumulated sediment from forebays when 50 percent of the forebay capacity is silted (Naval Facilities Engineering Service Center, 2004).
- Remove sediment from the main pool when 10 to 15 percent of the EDW permanent pool has been lost. A probing rod can be used to indicate when sediment has reached the depth corresponding to 10 percent to 15 percent of the EDW's storage volume (Metropolitan Nashville – Davidson County, 2000).

8.6.6.1 Sediment Removal

Some sediment may contain contaminants of which the Kansas Department of Health and Environment (KDHE) or Missouri Department of Natural Resources (MDNR) requires special disposal procedures. If there is any uncertainty about what the sediment contains or it is known to contain contaminants, then KDHE or MDNR should be consulted and their disposal recommendations followed. Sampling and testing shall be performed on sediments accumulated in facilities serving industrial, manufacturing or heavy commercial sites, fueling centers or automotive maintenance areas, large parking areas, or other areas where pollutants (other than “clean” soil) are suspected to accumulate and be conveyed via stormwater runoff (Metropolitan Nashville – Davidson County, 2000).

Some sediment collected may be innocuous (free of pollutants other than clean soil) and can be used as fill material, cover, or land spreading. It is important that this material not be placed in a way that will promote or allow resuspension in stormwater runoff. The sediment should not be placed within the high water level area of the EDW, other BMP, creek, waterway, buffer, runoff conveyance device, or other infrastructure. Some demolition or sanitary landfill operators will allow the sediment to be disposed at their facility for use as cover. This generally requires that the sediment be tested to ensure that it is innocuous (Metropolitan Nashville – Davidson County, 2000).

8.6.7 Design Example

The following sections present an example for designing an EDW. These procedures follow the steps outlined in the Design Procedure Form: Extended Detention Wetland Main Worksheet. When using the worksheet in electronic form, manually enter values in green.

8.6.7.1 Example

You are designing an extended detention wetland to treat stormwater runoff from a 35-acre tributary area that is developed for mixed use, including a shopping center and medium- and high-density residential areas. Size the permanent pool and WQvs of the EDW and incorporate an outlet structure that will release the WQv over a period of 40 hours.

I. Basin Water Quality Volume

Step 1 - Enter the tributary area to the EDW (A_T).

Step 2 - Calculate the WQv using the methodology presented in Section 6 of this manual.

Ila. Permanent Pool Volume, Method 1 (Florida Department of Environmental Regulation, 1988)

This method calculates the permanent pool volume required to provide a minimum detention time of 14 days to allow sufficient time for the uptake of dissolved phosphorus by algae and the settling of fine solids where the particulate phosphorus tends to be concentrated.

Step 1 - Enter the average 14-day wet season rainfall (R_{14}). Based on the period of record for Kansas City, this is 2.2 inches.

Step 2 - Determine the Rational runoff coefficient (C) for the tributary area. This value can be obtained from APWA Section 5602.3 or estimated by delineating pervious and impervious components of the tributary area:

$$C = 0.3 + 0.6 * I;$$

I = percent impervious area divided by 100

Step 3 - Calculate the permanent pool volume (V_{P1}) from the runoff coefficient, tributary area, and average 14-day wet season rainfall:

$$V_{P1} = (C * A_T * R_{14})/12$$

IIb. Permanent Pool Volume, Method 2 (EPA, 1986)

This method calculates the permanent pool volume required to settle out suspended solids to the basin bottom.

- Step 1 - Select the WQv/runoff volume ratio ($V_{B/R}$) from **Figure 8.6** based on desired total suspended solids (TSS) removal efficiency. This ratio should be at least 4.
- Step 2 - Determine the mean storm depth (S_d) for your region. For the Kansas City area, this depth is 0.6 inches.
- Step 3 - Calculate the total impervious tributary area (A_i) to the EDW in acres.
- Step 4 - Calculate the permanent pool volume (V_{P2}) from the values determined in Steps 1, 2, and 3:

$$V_{P2} = (V_{B/R} * S_d * A_i) / 12$$

IIc. Permanent Pool Design Volume

- Step 1 - Choose the larger of two permanent pool volumes calculated in Parts IIa and IIb and 20% to account for sedimentation. This value is the design volume (V_p) for the permanent pool.
- Step 2 - Set the permanent pool volume allocations (V_A) between the forebay, micropool, low marsh, and high marsh. Recommended allocations are given in **Table 8.4**. From the percentages entered ($V\%$), calculate the volumes of each zone from the total permanent pool volume determined in Step 1.

$$V_{A, \text{Forebay}} = V_{\%, \text{Forebay}} * V_P$$

$$V_{A, \text{Micropool}} = V_{\%, \text{Micropool}} * V_P$$

$$V_{A, \text{Low Marsh}} = V_{\%, \text{Low Marsh}} * V_P$$

$$V_{A, \text{High Marsh}} = V_{\%, \text{High Marsh}} * V_P$$

III. Forebay

- Step 1 - Enter forebay volume (Vol_{FB}) as calculated in Part IIc, Step 2.
- Step 2 - Calculate the forebay depth (Z_{FB}) from the volume and the surface area. The forebay depth should be between 4 feet and 6 feet.
- Step 3 - Ensure that the sides and bottom of the forebay are paved or hardened to ease removal of silt and sedimentation from the forebay.

IV. Micropool

- Step 1 - Enter micropool volume (Vol_{MP}) as calculated in Part IIc, Step 2.
- Step 2 - Calculate the micropool depth (Z_{MP}) from the volume calculated in Step 1 and the surface area. If the micropool depth is not between 4 feet and 6 feet, adjust the surface area to achieve a depth in this range.
- Step 3 - Ensure that all deep micropools are surrounded by a safety bench at least 12 feet wide.

Va. Water Quality Outlet Type

- Step 1 - Select type of water quality outlet. Water quality outlet configurations are shown on **Figures 8.7** and **8.8**.
- Step 2 - Proceed to Part Vb, Vc, or Vd based on water quality outlet type selected in Step 1.

Vb. Water Quality Outlet, Single Orifice (City of Knoxville, 2001)

- Step 1 - Enter WQv depth above WQv outlet (Z_{WQ}).
- Step 2 - Calculate the average head of the WQv over the orifice invert (H_{WQ}) as $\frac{1}{2}$ the WQv depth:

$$H_{WQ} = 0.5 * Z_{WQ}$$

Step 3 - Calculate the average water quality outflow rate (Q_{WQ}) that would result in the entire WQv draining over a period of 40 hours:

$$Q_{WQ} = (WQv * 43,560)/(40 * 3,600)$$

Step 4 - Set the value of the orifice discharge coefficient (C_o) based on orifice geometry and thickness of riser/weir plate.

Step 5 - Calculate the required water quality outlet orifice diameter (D_o) from parameters determined in Steps 2, 3, and 4. Orifice diameter should be larger than 4 inches to reduce the chance for clogging. If calculated orifice diameter is less than 4 inches, use perforated riser, weir plate, or v-notch weir outlet instead of single orifice.

$$D_o = 12 * 2 * (Q_{WQ}/(C_o * \pi * (2 * g * H)^{0.5}))^{0.5}$$

Step 6 - To size a single water quality outlet orifice for an EDW with an irregular stage-volume relationship, use the Single Orifice Worksheet. Fill in the first column with cumulative volume values for each depth interval. The Single Orifice Worksheet uses values from Part Vb of the Main Worksheet.

Vc. Water Quality Outlet, Perforated Riser, or Plate (Urban Drainage and Flood Control District, Denver, Colorado, 2005)

Step 1 - Enter WQv depth above WQv outlet (Z_{WQ}).

Step 2 - Calculate the recommended maximum outlet area per row of perforations (A_o) based on the WQv and the depth at the basin outlet:

$$A_o = WQv/(0.013 * Z_{WQ}^2 + 0.22 * Z_{WQ} - 0.10)$$

Step 3 - Assuming a single column, calculate the diameter of a single circular perforation (D_1) for each row based on the outlet area calculated in Step 2.

Step 4 - Set the number of columns of perforations (n_c). Keep this number as low as possible, optimally 1. If the diameter calculated in Step 3 is greater than 2 inches, make the number of columns greater than 1.

Step 5 - Calculate the design circular perforation diameter (D_{per}) based on the area calculated in Step 2 and the number of columns set in Step 4. Iteratively increase the number of columns until this design diameter is between 1 and 2 inches.

Step 6 - Calculate the horizontal perforation column spacing (S_c), center to center, when the number of columns is greater than 1. As long as the perforation diameter calculated in Step 5 is greater than 1, the horizontal perforation column spacing should be 4 inches.

Step 7 - Calculate the number of rows of perforations (n_r), center to center, based on a 4-inch vertical spacing and depth at outlet from Step 1.

Vd. Water Quality Outlet, V-Notch Weir (City of Knoxville, 2001)

Step 1 - Enter WQv depth above WQv outlet (Z_{WQ}).

Step 2 - Calculate the average head of the WQv over the v-notch invert (H_{WQ}) as ½ the WQv depth:

$$H_{WQ} = 0.5 * Z_{WQ}$$

Step 3 - Calculate the average water quality outflow rate (Q_{WQ}) that would result in the entire WQv draining over a period of 40 hours:

$$Q_{WQ} = (WQv * 43,560)/(40 * 3,600)$$

Step 4 - Select the value of the v-notch weir discharge coefficient ($C_v = 2.5$ typical).

Step 5 - Calculate the required v-notch weir angle (θ) from parameters determined in Steps 2, 3, and 4. If the calculated v-notch weir angle is less than 20 degrees, set to 20 degrees.

$$\theta = 2 * \arctan (Q_{WQ} / (C_v * H_{WQ}^{5/2}))$$

Step 6 - Calculate the top width of the v-notch weir (W_v):

$$W_v = 2 * Z_{WQ} * \text{TAN}(\theta/2)$$

Step 7 - To size a v-notch weir for an EDW with an irregular stage-volume relationship, use the V-Notch Weir Worksheet. Fill in the first column with cumulative volume values for each depth interval. The V-Notch Weir Worksheet uses values from Part Vd of the Main Worksheet.

VI. Water Budget

Perform water budget calculations for each zone of the EDW following the techniques in Chapter 13 of the NRCS *Engineering Field Handbook* to ensure that wetland vegetation can be sustained during the growing season.

VII. Trash Racks (Urban Drainage and Flood Control District, Denver, Colorado, 2005)

Step 1 - Calculate the total water quality outlet area (A_{ot}) from Vb, Vc, or Vd, whichever outlet configuration you selected.

Step 2 - Calculate the required trash rack open area (A_t) from the total outlet area. **Figures 8.8 and 8.9** show suggested details for trash racks over perforated riser outlets.

$$A_t = A_{ot} * 77 * e^{(-0.124 * D)} \text{ for single orifice outlet}$$

$$A_t = (A_{ot}/2) * 77 * e^{(-0.124 * D)} \text{ for orifice plate or perforated riser outlet}$$

$$A_t = 4 * A_{ot} \text{ for v-notch weir outlet}$$

VIII. EDW Shape

Ensure that the flow path through the EDW has a length to width ratio of at least 3:1.

IX. EDW Side Slopes (Metropolitan Nashville – Davidson County, 2000)

Basin side slopes should be at least 4:1 (H:V) to facilitate maintenance and public safety. Side slopes should be stabilized, preferably with native vegetative cover.

X. Vegetation (Urban Drainage and Flood Control District, Denver, Colorado, 2005)

Step 1 - EDW berms and side slope areas should be planted with native grasses or with irrigated turf to provide erosion control, depending on the local setting and needs. High and low marshes should be planted with native wetland species to promote sediment settling and biological uptake of nutrients. Vegetation is discussed in more detail in **Appendix A** of this manual.

Step 2 - Describe the mix and density of wetland species to be planted in the marsh areas.

XI. Inlet (Urban Drainage and Flood Control District, Denver, Colorado, 2005)

Dissipate flow energy at the EDW inflow point(s) to limit erosion and promote particle sedimentation.

XII. Access (Urban Drainage and Flood Control District, Denver, Colorado, 2005)

All-weather stable access to the marsh zones, forebay, micropool, and outlet works area shall be provided for maintenance vehicles. Grades should not exceed 10 percent along access paths, and a solid driving surface of gravel, rock, concrete, or gravel-stabilized turf should be provided.

TABLE 8.4
Volume Allocations in Extended Detention Wetlands

EDW Zone	Percent of Total EDW Volume
Forebay	20
Micropool	20
Low Marsh (6" to 18" below permanent pool)	40
High Marsh (0" to 6" below permanent pool)	20

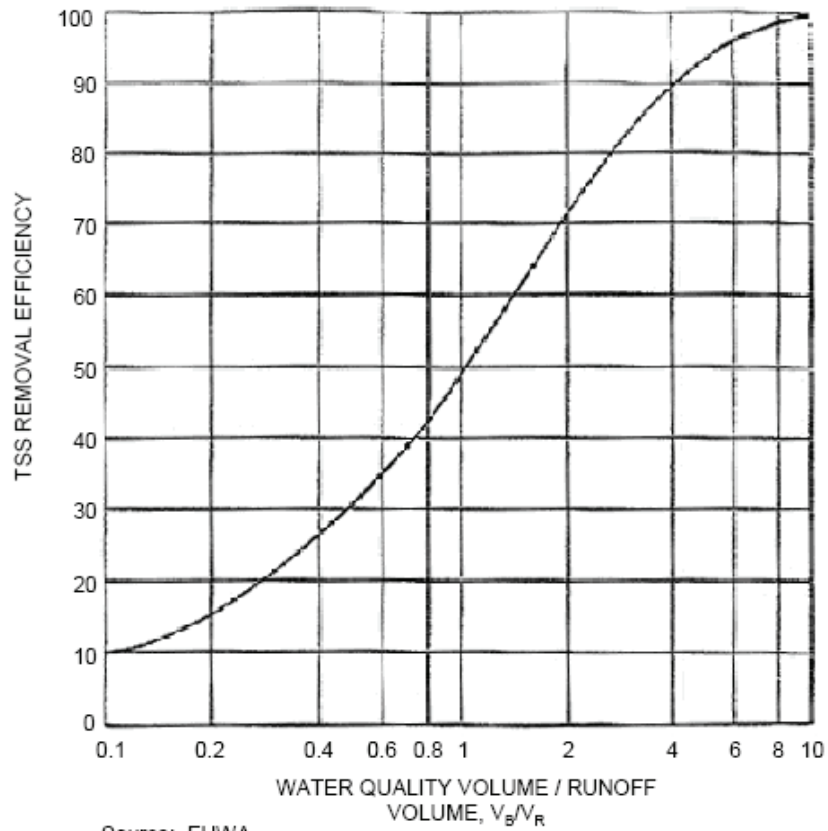

Source: FHWA
 (1989)

Figure 8.6 - TSS Removal Efficiency of an EDW

**Design Procedure Form: Extended Detention Wetland (EDW)
Main Worksheet**

Designer: _____
Checked By: _____
Company: _____
Date: _____
Project: _____
Location: _____

I. Basin Water Quality Volume																	
Step 1) Tributary area to EDW, A_T (ac)	A_T (ac) =	35.0															
Step 2) Calculate WQV using methodology in Section 6	WQV (ac-ft) =	2.2															
IIa. Permanent Pool Volume, Method 1																	
Step 1) Average 14 day wet season rainfall, R_{14} (in)	R_{14} (in) =	2.2															
Step 2) Rational runoff coefficient, C $C = (A_I * C_I + A_P * C_P) / A_T$ A_I = impervious area, C_I = 0.95 A_P = pervious area, C_P = 0.20	C =	0.6															
Step 3) Permanent pool volume by Method 1, V_{P1} (ac-ft) $V_{P1} = (C * A_T * R_{14}) / 12$	V_{P1} (ac-ft) =	3.9															
IIb. Permanent Pool Volume, Method 2																	
Step 1) Ratio of basin volume to runoff volume, $V_{B/R}$ (from Figure 24; $V_{B/R}$ should be ≥ 4.0)	$V_{B/R}$ =	5.0															
Step 2) Mean storm depth, S_d (in)	S_d (in) =	0.6															
Step 3) Impervious tributary area, A_I (ac)	A_I (ac) =	19															
Step 4) Permanent pool volume by Method 2, V_{P2} (ac-ft) $V_{P2} = (V_{B/R} * S_d * A_I) / 12$	V_{P2} (ac-ft) =	4.8															
IIc. Permanent Pool Design Volume																	
Step 1) Permanent pool design volume, V_P , as larger of volumes calculated in 2a and 2b plus 20%	V_P (ac-ft) =	5.7															
Step 2) Permanent pool volume allocations ⁵	<table border="1" style="margin-left: auto; margin-right: auto; border-collapse: collapse;"> <thead> <tr> <th>EDW Zone</th> <th>% of Permanent Pool Volume⁵ $V_{\%}$</th> <th>Volume Allocation V_A (ac-ft)</th> </tr> </thead> <tbody> <tr> <td>Forebay</td> <td align="center">20%</td> <td align="center">1.1</td> </tr> <tr> <td>Micropool</td> <td align="center">20%</td> <td align="center">1.1</td> </tr> <tr> <td>Low Marsh (6" to 18" depth)</td> <td align="center">40%</td> <td align="center">2.3</td> </tr> <tr> <td>High Marsh (0" to 6" depth)</td> <td align="center">20%</td> <td align="center">1.1</td> </tr> </tbody> </table>	EDW Zone	% of Permanent Pool Volume ⁵ $V_{\%}$	Volume Allocation V_A (ac-ft)	Forebay	20%	1.1	Micropool	20%	1.1	Low Marsh (6" to 18" depth)	40%	2.3	High Marsh (0" to 6" depth)	20%	1.1	
EDW Zone	% of Permanent Pool Volume ⁵ $V_{\%}$	Volume Allocation V_A (ac-ft)															
Forebay	20%	1.1															
Micropool	20%	1.1															
Low Marsh (6" to 18" depth)	40%	2.3															
High Marsh (0" to 6" depth)	20%	1.1															
$V_{A,Forebay} = V_{\%Forebay} * V_P$																	
$V_{A,Micropool} = V_{\%Micropool} * V_P$																	
$V_{A,Low Marsh} = V_{\%LowMarsh} * V_P$																	
$V_{A,High Marsh} = V_{\%High Marsh} * V_P$																	
III. Forebay																	
Step 1) Enter forebay volume as calculated in Part IIc, Step 2	Vol_{FB} (ac-ft) =	1.1															
Step 2) Forebay depth, Z_{FB} (ft), should be between 4 and 6 feet	Z_{FB} (ft) =	4															
Step 3) Paved/hard bottom and sides?		Yes															

**Design Procedure Form: Extended Detention Wetland (EDW)
Main Worksheet**

Designer: _____
Checked By: _____
Company: _____
Date: _____
Project: _____
Location: _____

IV. Micropool	
Step 1) Enter micropool volume as calculated in Part IIc, Step 2	Vol _{MP} (ac-ft) = <u>1.1</u>
Step 2) Micropool depth, Z _{MP} (ft), should be between 4 and 6 feet	Z _{MP} (ft) = <u>4</u>
Step 3) Safety bench width, W _{SB} (ft), should be a minimum of 12 ft	W _{SB} (ft) = <u>12</u>
Va. Water Quality Outlet Type	
Step 1) Set water quality outlet type: Type 1 = single orifice Type 2 = perforated riser or plate Type 3 = v-notch weir	Outlet Type = <u>1</u>
Step 2) Proceed to part Vb, Vc, or Vd based on water quality outlet type selected	
Vb. Water Quality Pool Outlet, Single Orifice	
Step 1) Depth of water quality volume above permanent pool, Z _{WQ} (ft)	Z _{WQ} (ft) = <u>0.3</u>
Step 2) Average head of water quality volume over invert of orifice, H _{WQ} (ft) $H_{WQ} = 0.5 * Z_{WQ}$	H _{WQ} (ft) = <u>0.2</u>
Step 3) Average water quality outflow rate, Q _{WQ} (cfs) $Q_{WQ} = (WQv * 43,560) / (40 * 3,600)$	Q _{WQ} (cfs) = <u>0.67</u>
Step 4) Set value of orifice discharge coefficient, C _o C _o = 0.66 when thickness of riser/weir plate is = or < orifice diameter C _o = 0.80 when thickness of riser/weir plate is > orifice diameter	C _o = <u>0.66</u>
Step 5) Water quality outlet orifice diameter (minimum of 4 inches), D _o (in) $D_o = 12 * 2 * (Q_{WQ} / (C_o * \pi * (2 * g * H)^{0.5}))^{0.5}$ (If orifice diameter < 4 inches, use outlet type 2 or 3)	D _o (in) = <u>7.71</u>
Step 6) To size outlet orifice for EDW with an irregular stage-volume relationship, use the Single Orifice Worksheet	
Vc. Water Quality Outlet, Perforated Riser	
Step 1) Depth of water quality volume above permanent pool, Z _{WQ} (ft)	Z _{WQ} (ft) = <u>0.3</u>
Step 2) Recommended maximum outlet area per row, A _o (in ²) $A_o = WQv / (0.012 * Z_{WQ}^2 + 0.14 * Z_{WQ} - 0.060)$ (Equation from Reference 2 for EDW with 40-hour drawdown)	A _o (in ²) = <u>2200</u>
Step 3) Circular perforation diameter per row assuming a single column, D ₁ (in)	D ₁ (in) = <u>52.9</u>
Step 4) Number of columns, n _c	n _c = <u>800</u>
Step 5) Design circular perforation diameter (between 1 and 2 inches), D _{perf} (in)	D _{perf} (in) = <u>1.9</u>
Step 6) Horizontal perforation column spacing when n _c > 1, center to center, S _c If D _{perf} ≥ 1.0 in, S _c = 4	S _c (in) = <u>4</u>
Step 7) Number of rows (4" vertical spacing between perforations, center to center), n _r	n _r = <u>1</u>

**Design Procedure Form: Extended Detention Wetland (EDW)
Main Worksheet**

Designer: _____
Checked By: _____
Company: _____
Date: _____
Project: _____
Location: _____

<u>Vd. Water Quality Outlet, V-Notch Weir</u>	
Step 1) Depth of water quality volume above permanent pool, Z_{WQ} (ft)	Z_{WQ} (ft) = <u>0.3</u>
Step 2) Average head of water quality pool volume over invert of v-notch, H_{WQ} (ft) $H_{WQ} = 0.5 * Z_{WQ}$	H_{WQ} (ft) = <u>0.2</u>
Step 3) Average water quality pool outflow rate, Q_{WQ} (cfs) $Q_{WQ} = (WQv * 43,560)/(40 * 3,600)$	Q_{WQ} (cfs) = <u>0.7</u>
Step 4) V-notch weir coefficient, C_v	C_v = <u>2.5</u>
Step 5) V-notch weir angle, θ (deg) $\theta = 2 * \arctan(Q_{WQ}/(C_v * H_{WQ}^{5/2}))$ V-notch angle should be at least 20 degrees. Set to 20 degrees if calculated angle is smaller.	θ (deg) = <u>176</u>
Step 6) V-notch weir top width, W_v (ft) $W_v = 2 * Z_{WQ} * \tan(\theta/2)$	W_v (ft) = <u>18.3</u>
Step 7) To calculate v-notch angle for EDW with an irregular stage-volume relationship, use the V-notch Weir Worksheet	
<u>VI. Water Budget</u>	
Perform water budget calculations following the procedure in Chapter 13 of the NRCS Engineering Field Handbook to ensure that a permanent pool can be maintained during the growing season.	
<u>VII. Trash Racks</u>	
Step 1) Total outlet area, A_{ot} (in ²)	A_{ot} (in ²) = <u>47</u>
Step 2) Required trash rack open area, A_t (in ²) $A_t = A_{ot} * 77 * e^{(0.124 * D)}$ for single orifice outlet $A_t = (A_{ot}/2) * 77 * e^{(0.124 * D)}$ for orifice plate or perforated riser outlet $A_t = 4 * A_{ot}$ for v-notch weir outlet	A_t (in ²) = <u>1,382</u>
<u>VIII. EDW Shape</u>	
Flow path through EDW should have a minimum length-to-width ratio of 3:1	L:W = <u>3.0</u>
<u>IX. EDW side slopes</u>	
Side slopes should be at least 4:1 (H:V)	Side Slope (H:V) = <u>4.0</u>
<u>X. Vegetation</u>	
Step 1) Check the method of vegetation planted in the EDW or describe "other"	<input checked="" type="checkbox"/> Native Grass <input type="checkbox"/> Irrigated Turf Grass <input checked="" type="checkbox"/> Wetland Species in Pool Other: _____
Step 2) Describe mix and density of wetland species. Appendix A provides plant recommendations for EDWs. _____ _____ _____	
<u>XII. Inlet Protection</u>	
Indicate method of inlet protection/energy dissipation at EDW inlet	<u>Rip-rap apron</u>

**Design Procedure Form: Extended Detention Wetland (EDW)
Main Worksheet**

Designer: _____
Checked By: _____
Company: _____
Date: _____
Project: _____
Location: _____

I. Basin Water Quality Volume																	
Step 1) Tributary area to EDW, A_T (ac)		A_T (ac) = _____															
Step 2) Calculate WQv using methodology in Section 6		WQv (ac-ft) = _____															
IIa. Permanent Pool Volume, Method 1																	
Step 1) Average 14 day wet season rainfall, R_{14} (in)		R_{14} (in) = _____															
Step 2) Rational runoff coefficient, C		C = _____															
$C = (A_I * C_I + A_P * C_P) / A_T$ A_I = impervious area, $C_I = 0.95$ A_P = pervious area, $C_P = 0.20$																	
Step 3) Permanent pool volume by Method 1, V_{P1} (ac-ft)		V_{P1} (ac-ft) = _____															
$V_{P1} = (C * A_T * R_{14}) / 12$																	
IIb. Permanent Pool Volume, Method 2																	
Step 1) Ratio of basin volume to runoff volume, $V_{B/R}$ (from Figure 24; $V_{B/R}$ should be ≥ 4.0)		$V_{B/R}$ = _____															
Step 2) Mean storm depth, S_d (in)		S_d (in) = _____															
Step 3) Impervious tributary area, A_I (ac)		A_I (ac) = _____															
Step 4) Permanent pool volume by Method 2, V_{P2} (ac-ft)		V_{P2} (ac-ft) = _____															
$V_{P2} = (V_{B/R} * S_d * A_I) / 12$																	
IIc. Permanent Pool Design Volume																	
Step 1) Permanent pool design volume, V_P , as larger of volumes calculated in 2a and 2b plus 20%		V_P (ac-ft) = _____															
Step 2) Permanent pool volume allocations ⁵																	
	<table border="1" style="margin-left: auto; margin-right: auto;"> <thead> <tr> <th>EDW Zone</th> <th>% of Permanent Pool Volume⁵</th> <th>Volume Allocation</th> </tr> </thead> <tbody> <tr> <td>Forebay</td> <td align="center">20%</td> <td>_____</td> </tr> <tr> <td>Micropool</td> <td align="center">20%</td> <td>_____</td> </tr> <tr> <td>Low Marsh (6" to 18" depth)</td> <td align="center">40%</td> <td>_____</td> </tr> <tr> <td>High Marsh (0" to 6" depth)</td> <td align="center">20%</td> <td>_____</td> </tr> </tbody> </table>	EDW Zone	% of Permanent Pool Volume ⁵	Volume Allocation	Forebay	20%	_____	Micropool	20%	_____	Low Marsh (6" to 18" depth)	40%	_____	High Marsh (0" to 6" depth)	20%	_____	
EDW Zone	% of Permanent Pool Volume ⁵	Volume Allocation															
Forebay	20%	_____															
Micropool	20%	_____															
Low Marsh (6" to 18" depth)	40%	_____															
High Marsh (0" to 6" depth)	20%	_____															
$V_{A,Forebay} = V_{\%Forebay} * V_P$																	
$V_{A,Micropool} = V_{\%Micropool} * V_P$																	
$V_{A,Low Marsh} = V_{\%LowMarsh} * V_P$																	
$V_{A,High Marsh} = V_{\%High Marsh} * V_P$																	
III. Forebay																	
Step 1) Enter forebay volume as calculated in Part IIc, Step 2		Vol_{FB} (ac-ft) = _____															
Step 2) Forebay depth, Z_{FB} (ft), should be between 4 and 6 feet		Z_{FB} (ft) = _____															
Step 3) Paved/hard bottom and sides?		_____															

**Design Procedure Form: Extended Detention Wetland (EDW)
Main Worksheet**

Designer: _____
Checked By: _____
Company: _____
Date: _____
Project: _____
Location: _____

<u>IV. Micropool</u>	
Step 1) Enter micropool volume as calculated in Part IIc, Step 2	Vol _{MP} (ac-ft) = _____
Step 2) Micropool depth, Z _{MP} (ft), should be between 4 and 6 feet	Z _{MP} (ft) = _____
Step 3) Safety bench width, W _{SB} (ft), should be a minimum of 12 ft	W _{SB} (ft) = _____
<u>Va. Water Quality Outlet Type</u>	
Step 1) Set water quality outlet type: Type 1 = single orifice Type 2 = perforated riser or plate Type 3 = v-notch weir	Outlet Type = _____
Step 2) Proceed to part Vb, Vc, or Vd based on water quality outlet type selected	
<u>Vb. Water Quality Pool Outlet, Single Orifice</u>	
Step 1) Depth of water quality volume above permanent pool, Z _{WQ} (ft)	Z _{WQ} (ft) = _____
Step 2) Average head of water quality volume over invert of orifice, H _{WQ} (ft) $H_{WQ} = 0.5 * Z_{WQ}$	H _{WQ} (ft) = _____
Step 3) Average water quality outflow rate, Q _{WQ} (cfs) $Q_{WQ} = (WQv * 43,560) / (40 * 3,600)$	Q _{WQ} (cfs) = _____
Step 4) Set value of orifice discharge coefficient, C _o C _o = 0.66 when thickness of riser/weir plate is = or < orifice diameter C _o = 0.80 when thickness of riser/weir plate is > orifice diameter	C _o = _____
Step 5) Water quality outlet orifice diameter (minimum of 4 inches), D _o (in) $D_o = 12 * 2 * (Q_{WQ} / (C_o * \pi * (2 * g * H)^{0.5}))^{0.5}$ (If orifice diameter < 4 inches, use outlet type 2 or 3)	D _o (in) = _____
Step 6) To size outlet orifice for EDW with an irregular stage-volume relationship, use the Single Orifice Worksheet	
<u>Vc. Water Quality Outlet, Perforated Riser</u>	
Step 1) Depth of water quality volume above permanent pool, Z _{WQ} (ft)	Z _{WQ} (ft) = _____
Step 2) Recommended maximum outlet area per row, A _o (in ²) $A_o = WQv / (0.012 * Z_{WQ}^2 + 0.14 * Z_{WQ} - 0.060)$ (Equation from Reference 2 for EDW with 40-hour drawdown)	A _o (in ²) = _____
Step 3) Circular perforation diameter per row assuming a single column, D ₁ (in)	D ₁ (in) = _____
Step 4) Number of columns, n _c	n _c = _____
Step 5) Design circular perforation diameter (between 1 and 2 inches), D _{perf} (in)	D _{perf} (in) = _____
Step 6) Horizontal perforation column spacing when n _c > 1, center to center, S _c If D _{perf} >= 1.0 in, S _c = 4	S _c (in) = _____
Step 7) Number of rows (4" vertical spacing between perforations, center to center), n _r	n _r = _____

**Design Procedure Form: Extended Detention Wetland (EDW)
Main Worksheet**

Designer: _____
Checked By: _____
Company: _____
Date: _____
Project: _____
Location: _____

Vd. Water Quality Outlet, V-Notch Weir	
Step 1) Depth of water quality volume above permanent pool, Z_{WQ} (ft)	Z_{WQ} (ft) = _____
Step 2) Average head of water quality pool volume over invert of v-notch, H_{WQ} (ft) $H_{WQ} = 0.5 * Z_{WQ}$	H_{WQ} (ft) = _____
Step 3) Average water quality pool outflow rate, Q_{WQ} (cfs) $Q_{WQ} = (WQV * 43,560)/(40 * 3,600)$	Q_{WQ} (cfs) = _____
Step 4) V-notch weir coefficient, C_v	C_v = _____
Step 5) V-notch weir angle, θ (deg) $\theta = 2 * \arctan(Q_{WQ}/(C_v * H_{WQ}^{5/2}))$ V-notch angle should be at least 20 degrees. Set to 20 degrees if calculated angle is smaller.	θ (deg) = _____
Step 6) V-notch weir top width, W_v (ft) $W_v = 2 * Z_{WQ} * \tan(\theta/2)$	W_v (ft) = _____
Step 7) To calculate v-notch angle for EDW with an irregular stage-volume relationship, use the V-notch Weir Worksheet	
VI. Water Budget	
Perform water budget calculations following the procedure in Chapter 13 of the NRCS Engineering Field Handbook to ensure that a permanent pool can be maintained during the growing season.	
VII. Trash Racks	
Step 1) Total outlet area, A_{ot} (in ²)	A_{ot} (in ²) = _____
Step 2) Required trash rack open area, A_t (in ²) $A_t = A_{ot} * 77 * e^{(0.124 * D)}$ for single orifice outlet $A_t = (A_{ot}/2) * 77 * e^{(0.124 * D)}$ for orifice plate or perforated riser outlet $A_t = 4 * A_{ot}$ for v-notch weir outlet	A_t (in ²) = _____
VIII. EDW Shape	
Flow path through EDW should have a minimum length-to-width ratio of 3:1	L:W = _____
IX. EDW side slopes	
Side slopes should be at least 4:1 (H:V)	Side Slope (H:V) = _____
X. Vegetation	
Step 1) Check the method of vegetation planted in the EDW or describe "other"	<input type="checkbox"/> Native Grass <input type="checkbox"/> Irrigated Turf Grass <input type="checkbox"/> Wetland Species in Pool <input type="checkbox"/> Other: _____
Step 2) Describe mix and density of wetland species. Appendix A provides plant recommendations for EDWs. _____ _____ _____	
XII. Inlet Protection	
Indicate method of inlet protection/energy dissipation at EDW inlet _____	

Variable Dictionary

<u>Variable</u>	<u>Units</u>	<u>Definition</u>
A_i	ac	Impervious watershed area
A_o	in ²	Recommended maximum outlet area per row for perforated riser or weir plate
A_{ot}	in ²	Total open area of outlet structure
A_P	ac	Total required permanent pool surface area
A_t	in ²	Total required trash rack open area
A_T	ac	Tributary area to EDW
A_{WQ}	ac	Required surface area of WQv
C	none	Rational runoff coefficient
C_o	none	Orifice discharge coefficient
C_v	none	V-Notch weir discharge coefficient
D_o	in	Water quality outlet orifice diameter
D_1	in	Circular perforation diameter per row, assuming a single column, for perforated riser or weir plate
D_{perf}	in	Design circular perforation diameter for perforated riser or weir plate
H_{WQ}	ft	Average head of WQv over invert of water quality outlet
n_c	none	Number of columns of perforations for perforated riser or weir plate
n_r	none	Number of rows of perforations for perforated riser or weir plate
θ	deg	V-Notch weir angle
Q_{WQ}	cfs	Average WQv outflow rate
R_{14}	in	Average 14-day wet season rainfall
R_{avg}	in	Average wet season rainfall from period of record
$SA\%$	%	Permanent pool surface area percent by EDW zone
SA_A	ac	Permanent pool surface area allocation by EDW zone
S_c	in	Horizontal perforation column spacing for perforated riser or weir plate
S_d	in	Mean storm depth
$V\%$	%	Permanent pool volume percent by EDW zone
V_A	ac-ft	Permanent pool volume allocation by EDW zone
$V_{B/R}$	none	Ratio of basin volume to runoff volume
V_{design}	ac-ft	Design volume of EDW, accounts for 20% basin filling with sediment
V_P	ac-ft	Permanent pool design volume; taken as larger of V_{P1} and V_{P2}
V_{P1}	ac-ft	Permanent pool volume calculated by method 1
V_{P2}	ac-ft	Permanent pool volume calculated by method 2
Vol_{FB}	ac-ft	Pre-sedimentation forebay volume
Vol_{MP}	ac-ft	Micropool volume
WQv	ac-ft	Water quality volume
W_v	ft	V-notch weir top width
Z_{FB}	ft	Forebay depth
Z_{MP}	ft	Micropool depth
Z_{WQ}	ft	Depth of WQv above invert of outlet

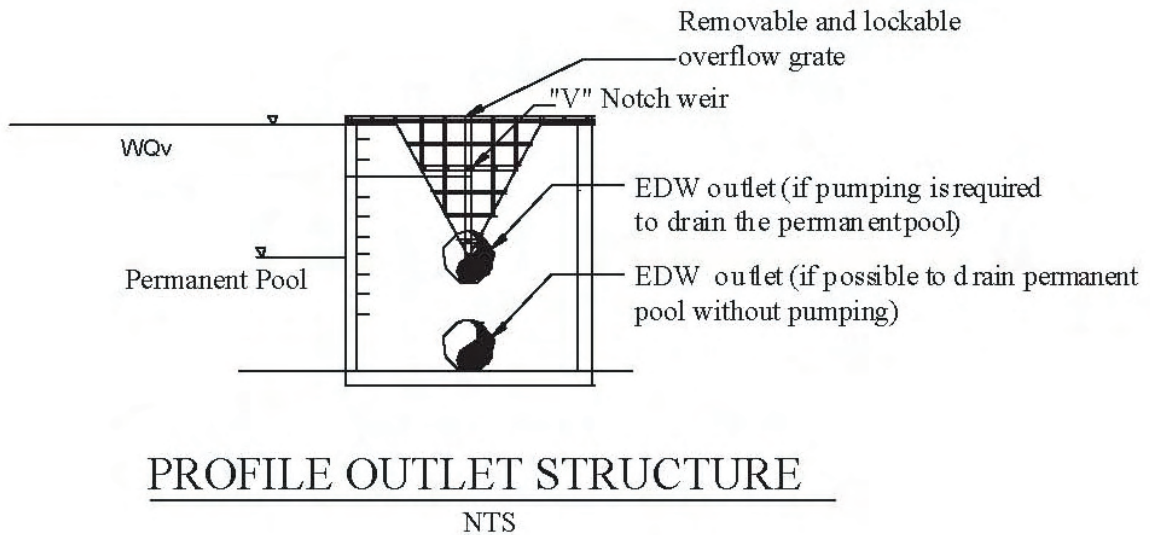
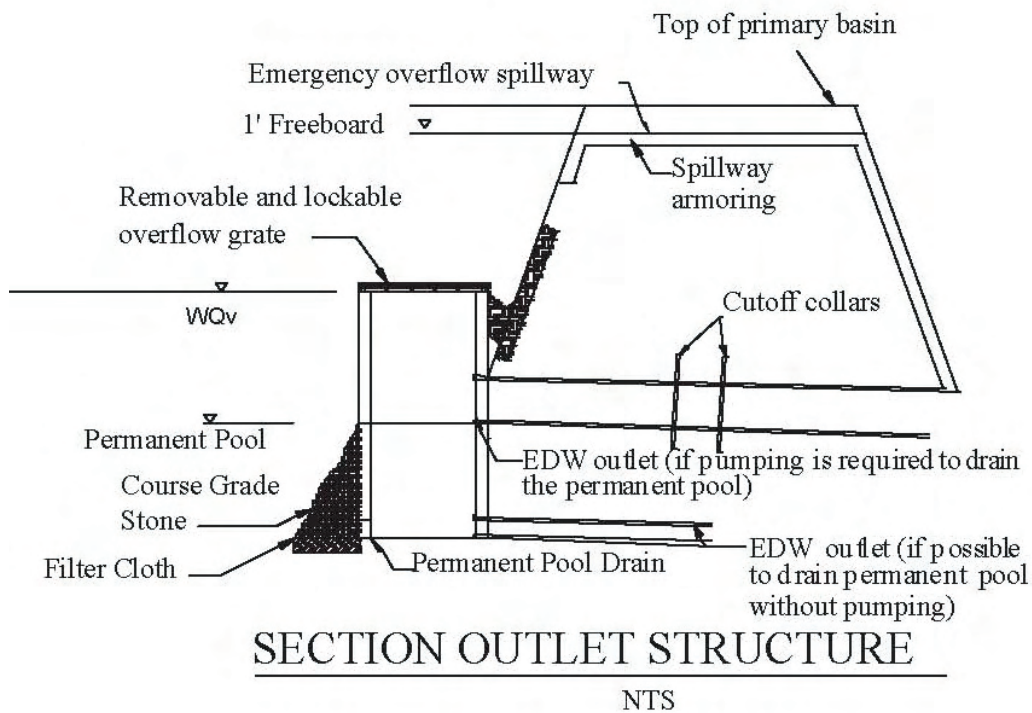
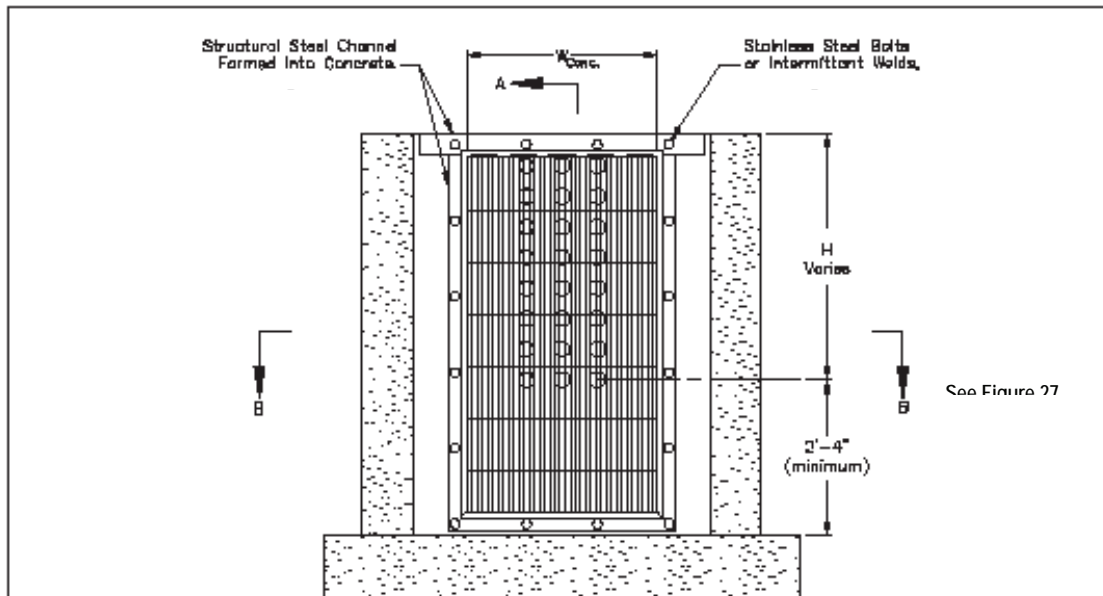

Figure 8.7 - "V" Notch Weir Outlet Structure



A ——— See Figure 27
Elevation

WQv Trash Racks:

1. Wall-screen trash racks shall be stainless steel and shall be attached by intermittent welds along the edge of the mounting frame.
2. Bar grate trash racks shall be aluminum and shall be bolted using stainless steel hardware.
3. Trash Rack widths are for specified trash rack material. Finer well-screen or mesh size than specified is acceptable, however, trash rack dimensions need to be adjusted for materials having a different open area/gross area ratio (R value)
4. Structural design of trash rack shall be based on full hydrostatic head with zero head downstream of the rack.

Overflow Trash Racks:

1. All trash racks shall be mounted using stainless steel hardware and provided with hinged and lockable or boltable access panels.
2. Trash racks shall be stainless steel, aluminum, or steel. Steel trash racks shall be hot dip galvanized and may be hot powder painted after galvanizing.
3. Trash Racks shall be designed such that the diagonal dimension of each opening is smaller than the diameter of the outlet pipe.
4. Structural design of trash rack shall be based on full hydrostatic head with zero head downstream of the rack.

Adapted from Denver Urban Drainage and Flood Control District

Figure 8.8 - WQv Outlet Orifice Plate and Trash Rack Design

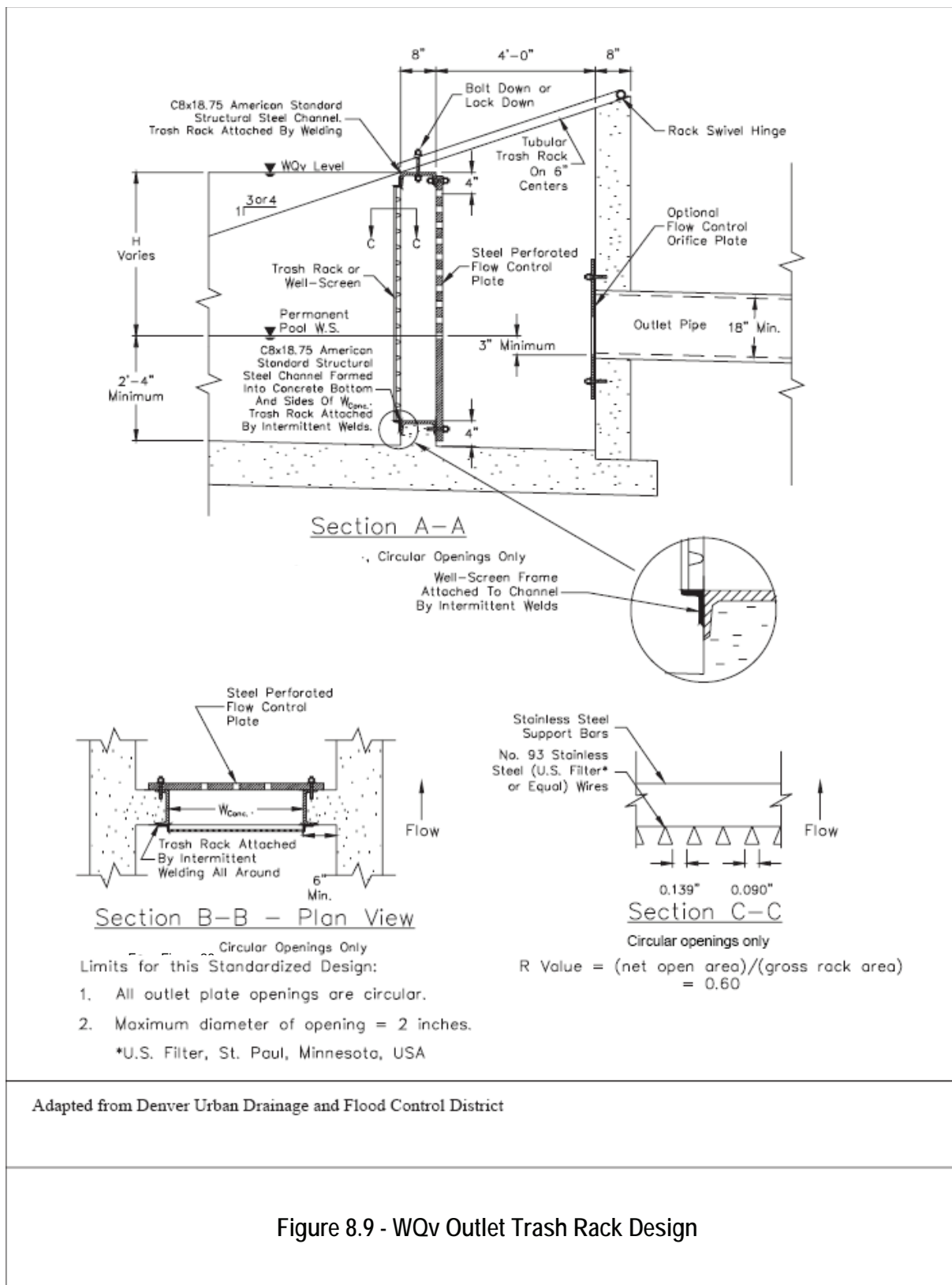

Adapted from Denver Urban Drainage and Flood Control District

Figure 8.9 - WQv Outlet Trash Rack Design

8.7 SAND FILTER

Pocket Sand Filter Plan and Profile Example (for informational purposes only)



Source: King County, Washington- www.metrokc.org

Targeted Constituents

Sediment	●
Nutrients	◐
Trash	●
Metals	◐
Bacteria	●
Oil and Grease	●
Organics	●

Legend (Removal Effectiveness)

High	Medium	Low
●	◐	○

8.7.1 Description

Sand filters are defined as stormwater quality treatment practices in which runoff is diverted to a self-contained bed of sand, collected in underground pipes, and discharged into a stream, channel, or sewer system. A typical sand filter system consists of two or three chambers or basins. The first is the sedimentation chamber, which removes floatable and heavy sediments. The second is the filtration chamber, which removes additional pollutants by filtering the runoff through a sand bed. The third is the discharge chamber. The treated filtrate normally is discharged through an underdrain system either to a storm drainage system or directly to surface waters. Sand filters take up little space and can be used on highly developed sites and sites with steep slopes. They can be added to retrofit existing sites. Sand filters can achieve high removal efficiencies for sediment, biological oxygen demand (BOD), and fecal coliform bacteria. Their ability to remove metals is moderate, and their ability to remove nutrients is often low.

8.7.2 General Application

Sand filters are intended primarily for water quality enhancement. In general, they are preferred over infiltration practices (such as infiltration trenches) when contamination of groundwater with conventional pollutants-BOD, suspended solids, and fecal coliform-is a concern. This usually occurs in areas where underlying soils alone cannot treat runoff adequately or where groundwater tables are high. Most sand filters can be constructed with impermeable basins or chamber bottoms, which help to collect, treat, and release runoff either to a storm drainage system or directly to surface water; this avoids contact between contaminated runoff and groundwater.

Sand filters are only feasible for highly impervious stabilized areas such as parking lots and rooftops. Sand for the filters should conform to AASHTO M-6 or ASTM C-33 ranging in size from 0.02 to 0.04 inch. Different configurations of sand filters are suitable for different types of sites depending on site conditions such as available space and type of development. The basic principles of all configurations are similar. Sand filter configurations include surface, underground, perimeter, and pocket. Each configuration is described in more detail below.

Surface sand filters (sometimes referred to as Austin sand filters) use an off-line sediment chamber to collect the first flush of stormwater; larger flows are diverted around the sedimentation chamber. Stormwater that is diverted into the sediment chamber is freed of coarse sediments. The water then flows from the sedimentation chamber into a depressional sand filter. The depressional area typically contains 18 inches of sand. The surface may be sand or preferably vegetation. Pounded water in the depressional area infiltrates through the sand and is collected in an

underdrain that conveys the treated water to the stream or channel at a downstream point. Calculate sizing of a surface sand filter assuming a porosity of 40 percent for the sand and gravel, a coefficient of permeability of 3.5 feet per day for the sand, and an appropriate sediment basin to reduce the chances of clogging. Size the sedimentation basin based on the fall velocity of the smallest particle that the basin should capture (usually sand). The fall velocities for various sized particles are in ASCE, Manuals and Reports on Engineering Practice, No. 54, Sedimentation Engineering. If the surface of the sand filter is vegetated, be sure to specify a species that will not impede infiltration. Surface sand filters are best suited for treating parking lot and roof runoff where space is not limited. Typically, the surface sand filter system is designed to handle runoff from drainage areas up to 50 acres. Pretreatment is essential to the success of a surface sand filter. **Figure 8.10** illustrates a typical surface sand filter.

Underground sand filters (also called Washington D.C. sand filters) use a three-chamber concrete vault placed at or beneath grade with the existing ground surface. The first chamber of the vault is used for pretreatment. It serves to settle coarse sediments and skim oil and floatable debris. The second chamber contains 18 inches of sand. Gravel, a protective screen, or permeable geotextile prevents clogging of the sand filter. Flow from the sand filter is collected in an underdrain and conveyed to the third chamber. The third chamber acts as a collection point for the stormwater. It fills and conveys the filtered stormwater through pipes to the stream or channel downstream. Provide access manholes of 30-inch minimum diameter for each chamber of the vault to allow cleaning. Typically, the underground sand filter system can handle runoff from completely impervious drainage areas of 1 acre or less. The sand filter system can accept the first 0.5 inch of runoff. Underground sand filters are ideal for retrofit situations where surface area is limited. **Figure 8.11** illustrates a typical underground sand filter.

Perimeter sand filters use a two-chamber concrete vault. A typical application is along the perimeter of a parking lot. The first chamber of the vault is used for pretreatment that settles out coarse sediments. Stormwater flows over a weir into the second chamber that contains an 18-inch layer of sand. An underdrain system collects the filtered stormwater and conveys it to the stream or channel downstream. Provide access manholes for each chamber of the vault. Perimeter sand filters are best suited for parking lots and rooftops where surface area is limited.

Pocket sand filters (also called Delaware sand filters) are simplified surface sand filters only applicable to small sites. Stormwater must be pretreated by a sediment basin, filter strip, or other means before entering a pocket sand filter. The pocket sand filter consists of an excavated, shallow, depressional area. The depressional area contains the 18-inch layer of sand covered by a 3- to 4-inch soil layer that is vegetated. Typically, pocket sand filters are constructed where surrounding soils have a permeability of 0.5 to 2 inches per hour to allow the filtered water to infiltrate into surrounding soils. Be sure to specify a species of vegetation for pocket filters that will survive frequent periods of ponding and drought but will not impede infiltration. Typical pocket sand filter systems can handle runoff from drainage areas of 5 acres or less. A major advantage of the pocket sand filter is its shallow structure depth of only 30 inches, which reduces construction and maintenance costs. **Figure 8.12** illustrates a typical pocket sand filter.

According to estimates, surface (Austin) sand filters, underground (Washington D.C.) sand filters, and pocket (Delaware) sand filters have the potential to remove 85 percent of suspended solids, 55 percent of phosphorous, 35 percent of nitrogen, and between 35 and 90 percent of metals from the stormwater (Claytor and Schueler 1996). Perimeter sand filters are estimated to remove 80 percent of suspended solids, 65 percent of phosphorous, and 45 percent of nitrogen.

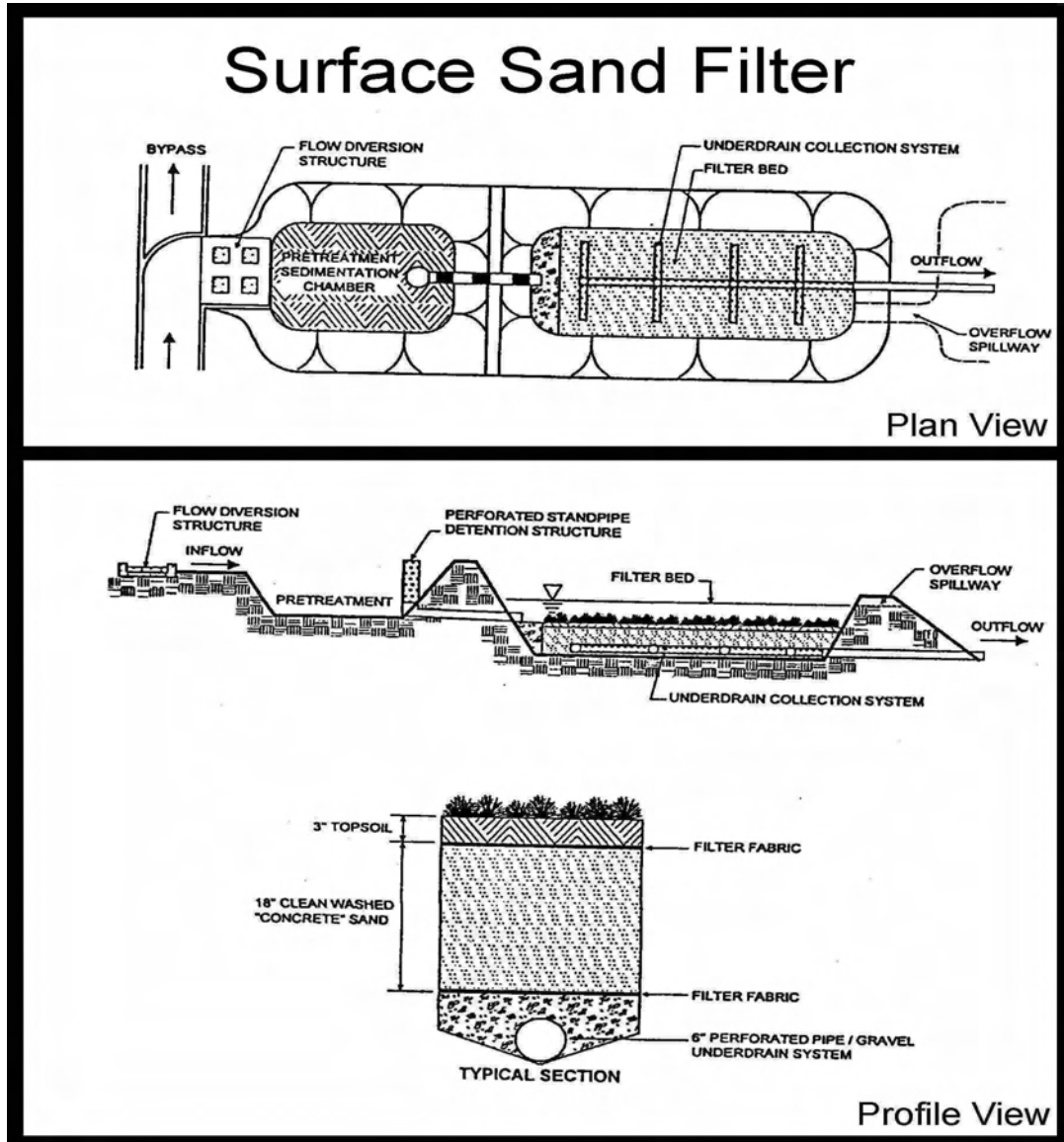

Source: CWP 1996

Figure 8.10 - Surface Sand Filter Plan and Profile Example
(for informational purposes only)

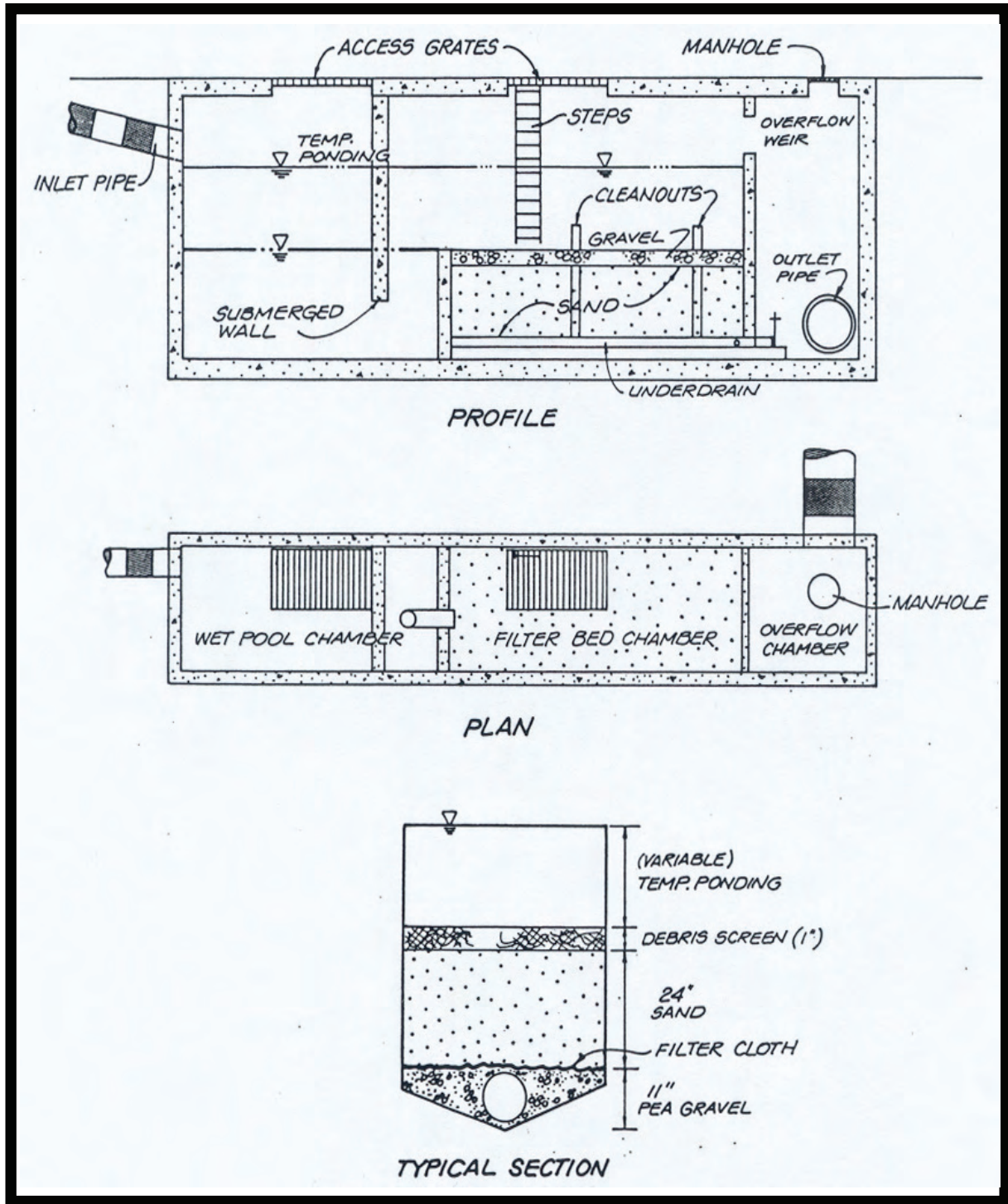

Figure 8.11 - Underground Sand Filter Plan and Profile Example
(for informational purposes only)

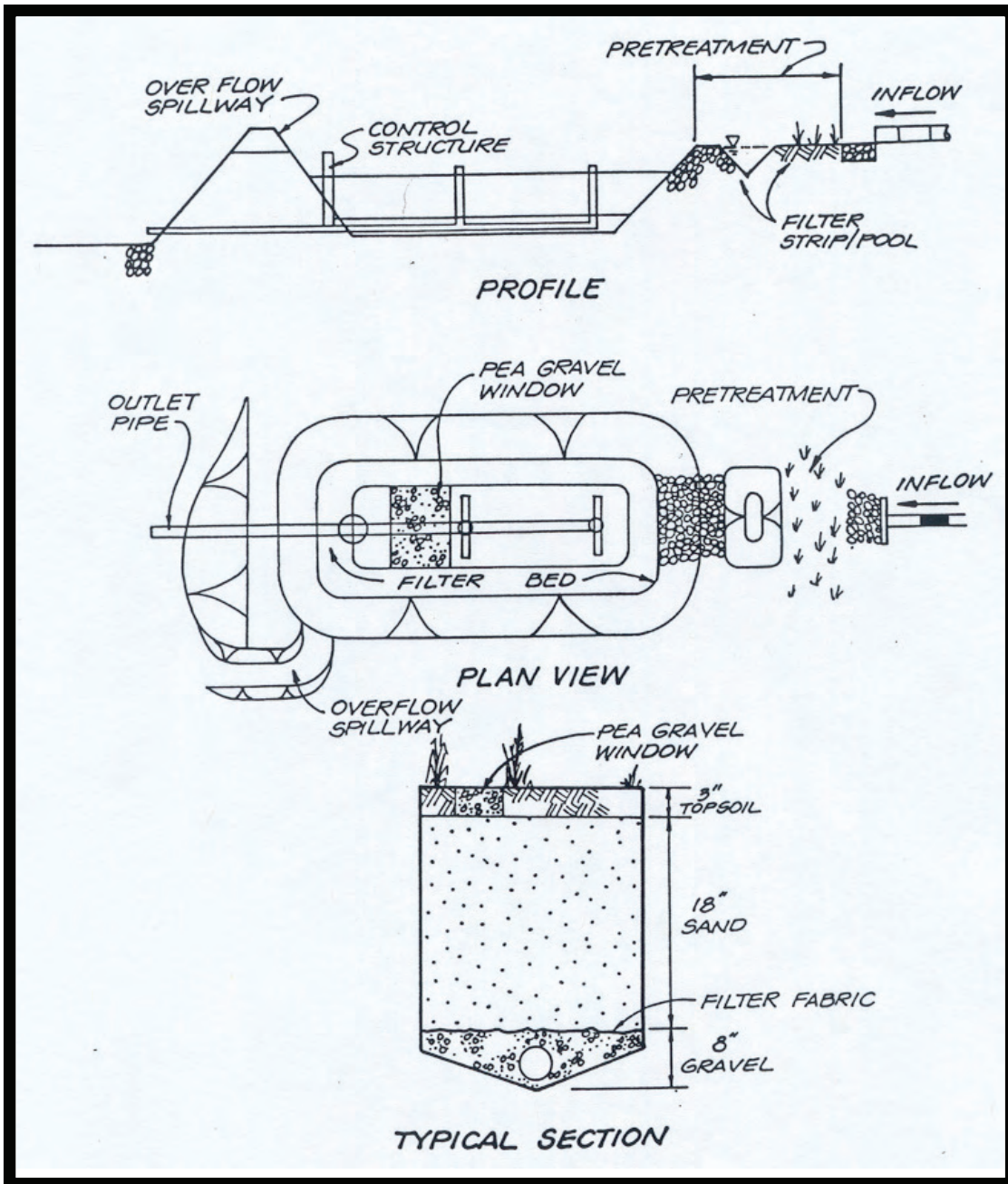

FIGURE 8.12 - Pocket Sand Filter Plan and Profile Example
(for informational purposes only)

8.7.3 Advantages

- Can effectively treat hot-spot runoff
- Consume small amounts of land (underground and perimeter sand filters)
- Improve water quality

8.7.4 Disadvantages

- OSHA-confined space for underground and perimeter sand filters
- Do not add aesthetic value

8.7.5 Design Requirements and Considerations

Restrict the contributing drainage to any sand filter to 5 acres or less. Design sand filters as off-line practices to capture and treat only the water quality storm and bypass all other storms. A flow regulation structure or flow splitter may be required along with the sand filter. Design a sedimentation basin in conjunction with all sand filters. Porosity (n) for sand and gravel should be 0.4 for sizing sand filters.

Determine the size of the sand filter bed surface area using Darcy's law:

$$A_f = WQv * d_f / [k * t_f (h_f + d_f)]$$

Where

A_f = Surface area of the sand filter (square feet)

d_f = Sand filter depth (feet)

k =
Coefficient of permeability for sand bed (feet per day)

h_f = Average height of water above the sand bed (feet; $h_f = \frac{1}{2} * h_{max}$, not to exceed 6 feet)

t_f = Time required for the WQv to filter through the sand bed (days; 40 hours is recommended)

Compute the minimum required storage within the sand filter as follows:

$$V_{min} = \frac{3}{4} * WQv$$

Compute the water volume within the filter bed using the following equation:

$$V_f = A_f * d_f * n$$

Where

n = porosity

For surface sand filters, compute the temporary water storage volume above the filter bed, V_{f-temp} .

Calculate the remaining volume required for the settling basin, V_s . V_s should be approximately 50 percent of V_{min} ; adjustments of h_f may be required to meet this criterion. V_s can be calculated as follows:

$$V_s = V_{min} - (V_f + V_{f-temp})$$

Where

V_{f-temp} = Temporary storage volume in the filter media

Calculate the height in the settling basin, h_s :

$$h_s = V_s / A_s$$

Where

A_s = Surface area of the BMP

Verify that $h_s > 2 * h_f$, and h_s equals or exceeds 3 feet. If not, adjust h_f and repeat the sizing procedure.

For underground sand filters, compute the minimum wet pool volume in the settling basin, V_w . As a minimum, $V_w = A_s * 3$.

Calculate the temporary storage volume required in both chambers:

$$V_{temp} = V_{min} - (V_f + V_w)$$

Compute the total surface area of both chambers, A_t :

$$A_t = A_f + A_s$$

Calculate the additional temporary storage height, h_{add} , using the following equation:

$$h_{add} = V_{temp} / A_t$$

Ensure that h_{add} equals or exceeds $2 * h_f$. Adjustments to h_f may be necessary to meet this requirement.

For perimeter sand filters, compute the minimum wet pool volume in the settling basin, V_w . As a minimum, $V_w = A_s * 2$.

Calculate the temporary storage volume required in both chambers:

$$V_{temp} = V_{min} - (V_f + V_w)$$

Compute the total surface area of both chambers, A_t :

$$A_t = A_s + A_f$$

Calculate the additional temporary storage height, H_{temp} , using the following equation:

$$h_{temp} = V_{temp} / A_t$$

Ensure that h_{temp} equals or exceeds $2 * h_f$. Adjustments to h_f may be necessary to meet this requirement.

For pocket sand filters, compute the temporary water storage volume above the filter bed, V_{temp} :

$$V_{temp} = V_{min} - V_f$$

Calculate the temporary storage height in the settling basin, h_{temp} :

$$H_{temp} = V_{temp} / A_{avg}, \text{ where } A_{avg} \text{ is the average area of the pocket sand filter.}$$

Set the emergency spillway elevation of the pocket sand filter at h_{temp} .

8.7.6 Maintenance and Inspections

The following is a partial list of maintenance issues related to sand filters:

- Inspect for erosion of pretreatment surface and pocket sand filters biannually
- Monitor the water level in underground sand filters quarterly

- Frequently inspect the overflow systems
- Frequently remove organic material from the site
- Frequently inspect and mow vegetation (keep less than 18 inches)
- Frequently remove sediment in the sediment basin or chamber
- Inspect structural components for degradation regularly

8.7.7 Design Example

To be completed at a later date.

8.8 WETLAND SWALES



Source: Olsson Associates

Targeted Constituents		
Sediment	●	High
Nutrients	◐	Medium
Trash	◐	Medium
Metals	◐	Medium
Bacteria	◐	Medium
Oil and Grease	●	High
Organics	●	High

Legend (Removal Effectiveness)		
High	Medium	Low
●	◐	○

8.8.1 Description

Wetland Swales are broad, shallow, natural, or constructed channels with a dense stand of native vegetation covering the side slopes and emergent vegetation covering the channel bottom. Unlike a Bio-Swale, a Wetland Swale does not include a prepared soil filter bed or underdrain system. They slowly convey stormwater runoff, and in the process promote infiltration, plant transpiration, adsorption, settling of suspended solids, and microbial breakdown of pollutants. Wetland Swales essentially act as a very long and linear shallow Wetland treatment system.

8.8.2 General Application

Wetland Swales can serve as part of a Stormwater drainage system and can replace curbs, gutters, and storm sewer systems. **Figure 8.13** illustrates a typical Wetland Swale. The feasibility of installing a Wetland Swale at a particular site depends on the area and slope of the contributing watershed. Wetland Swales can be used where the water table is at or near the surface or where there is a sufficient water balance in poorly drained soils to support a Wetland plant community. Wetland Swales are well suited for roadside applications or along the property boundaries of residential developments. The water quality volume for high density commercial and industrial land uses will most likely be too great to be accommodated with most Swale designs. However, Wetland Swales may be appropriate for pretreatment with other practices for these higher density land uses.

The tributary area should be stabilized before construction of a Wetland Swale. During construction, minimize disturbance to the underlying soil bed. A pre-treatment forebay may be required for sites expecting high levels of

suspended sediment to prevent premature clogging. Energy dissipation is needed at the inlet for all Wetland Swales that receive piped flow. Select grass and plant species that tolerate low maintenance and can survive without significant human influence (see **Appendix A**).

8.8.3 Advantages

- Constructed less expensively and maintained more easily than underground pipes
- Well suited to sites with relatively little slope
- Improve water quality by sedimentation and biological uptake

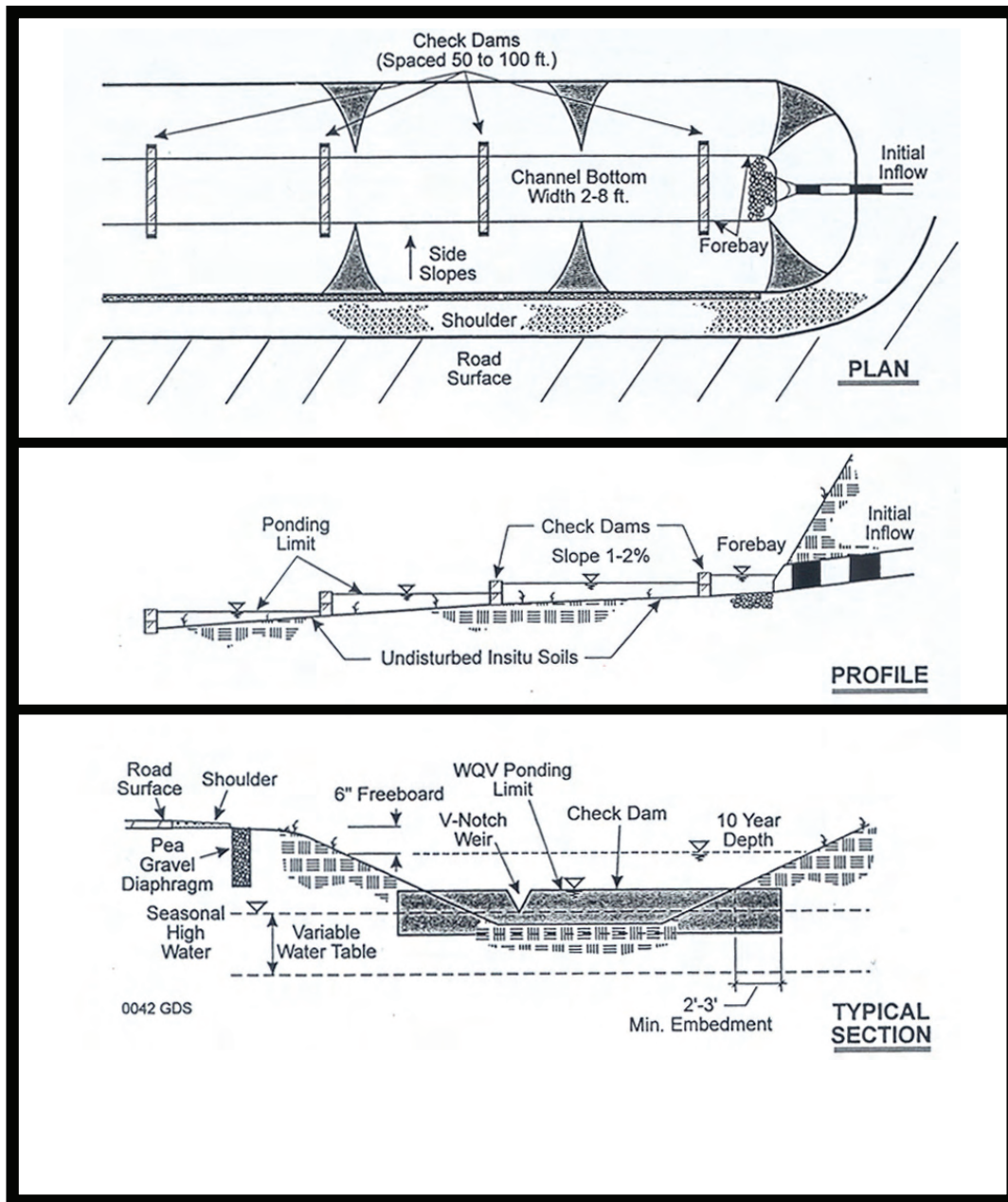

FIGURE 8.13 - Wetland Swale Plan and Profile Example
(for informational purposes only)

-
- Reduce total volume of runoff to surrounding streams and rivers
 - Minimize erosion by slowing the conveyance of water
 - Enhance biological diversity and create beneficial habitat between upland and surface waters.

8.8.4 Disadvantages

- May not be feasible to implement after development has occurred
- Impractical in areas with steep topography
- Area requirements can be excessive for highly developed sites
- May erode when flow volumes and/or velocities are high during storm events
- Not designed to be the fastest conveyance method and, therefore, require exact placement and design to minimize risk of flooding
- May attract mosquito and other nuisance vectors (See Section 8.12)
- Becomes less feasible along roadsides as the number of driveway entrances requiring culvers increase

8.8.5 Design Requirements and Considerations

The detention/retention capacity of a Wetland Swale is governed by the runoff associated with the “water quality storm.” This design approach for sizing Wetland Swales is based on temporarily storing the WQV within a shallow ponding area for a period of 24 hours. This methodology incorporates volume based sizing criteria for the WQV, and a rate based criteria for checking the erosive potential during the 50% storm event. If the Wetland Swale is intended to convey flow in excess of the 50% storm event consult local ordinances for design criteria. Do not use Wetland Swales as a BMP component to convey deep concentrated flow.

The following design specifications are summarized in **Table 8.5**.

8.8.5.1 *Shape and Slope*

- The Swales should generally be trapezoidal in shape, although a parabolic shape is also acceptable (provided the width is equal to or greater than the design bottom width for a trapezoidal cross section). The criteria presented in this section assume a trapezoidal cross section.
- For the trapezoidal cross section, size the bottom width between 2 and 8 feet. The 2-foot minimum allows for construction considerations and ensures a minimum filtering surface for water quality treatment. The 8-foot maximum reduces the likelihood of flow channelization within a portion of the Swale. Widths up to 16 feet may be used if separated by a dividing berm or structure to avoid braiding.
- The side slopes of the channel should be no steeper than 3:1 for maintenance and safety considerations. Flatter slopes are encouraged where adequate space is available to aid in providing pretreatment for lateral flows.
- A longitudinal slope less than 2% is recommended. When natural topography necessitates, steeper slopes may be acceptable if check dams (vertical drops of 6 to 12 inches) are used. These structures will require additional energy dissipating measures and should be placed no closer than 50 to 100 foot interval. V-notched weirs in the check dams can be utilized to direct flow and volumes.

TABLE 8.5
Design Summary for Wetland Swales

Parameter	Swale Design Criteria
Energy Dissipation	Required if piped inflow
Pretreatment	Use forebay if high sediment load expected
Bottom Width	2 feet minimum, 8 feet maximum, widths up to 16 feet are allowable if a dividing berm or structure is used
Side Slopes	3:1 or flatter preferred
Longitudinal Slope	Up to 2% without check dams
Underlying soil bed	Undisturbed soils equal to the Swale width No underdrain system
Drainage Area	5 acres or less
Sizing Criteria	Length, depth, width, and slope necessary to provide surface storage for WQv. Outlet structures sized to release WQv over 24 hours.
Depth and Capacity	Surface storage of WQV with a maximum depth of 18 inches for water quality treatment (12" average depth) Safely convey the 50% event with non-erosive velocity (< 4 fps). Consult local design criteria for flows greater than the 50% storm event.

8.8.5.2 Design Size and Soils

Source: Metropolitan Council of Environmental Services. 2001 Minnesota Urban Small Sites BMP Manual, St. Paul, MN.

Wetland Swales should have a contributing drainage area of 5 acres or less.

- The Swale length, width, depth, and slope should be designed to temporarily accommodate the WQv through surface ponding. The WQv must be retained for 24 hours but ponding may occur indefinitely depending on the depth and elevation of the water table.
- Design Swales to provide a shallow ponding depth for the WQv (a maximum of 18 inches - average depth 12 inches).
- Calculate the velocity and depth of flow through the Swale using the 50% design flow rate. Maximum flow velocity shall not exceed 4 fps and the maximum flow depth shall not exceed 2 ft at the 50% design flow rate. If these conditions are not attained, modify Swale geometry, each time altering the depth, bottom width or longitudinal slopes until these criteria are satisfied.
- Provide bypass for high flows if the Swale cannot be stable during the 10% or greater storm event.
- Check permissible velocities of soil and of selected vegetation to ensure the 50% storm event is non-erosive.

- Compute WQv drawdown time to ensure that it is 24 hours.
- The WQv for high density residential, commercial, and industrial land uses may be too great to be accommodated with most Swale designs. If the WQv is too great to be accommodated with Swale design, additional off-line storage may be incorporated (See **Figure 8.14**). In addition, Wetland Swales may be appropriate in association with other practices for these higher density land uses.

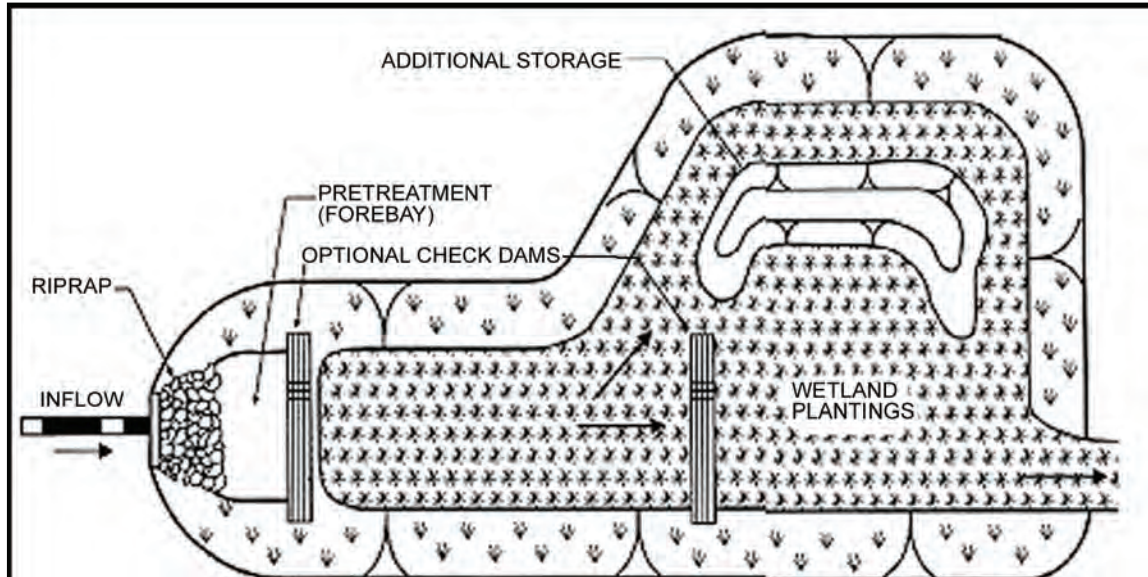

FIGURE 8.14 - Wetland Swale
(source: Minnesota Urban Small Sites BMP Manual)

- See that the soil bed below the Swale consists of undisturbed soils. This area may be periodically inundated and remain wet for long periods of time.
- Do not construct wet Swales in gravelly and coarse sandy soils that cannot easily support dense vegetation.
- Use outlet protection at any discharge point from Wetland Swales to prevent scour at the outlet.
- If the heavy sediment loading at a site is a concern provide pretreatment to protect the filtering and infiltration capacity of the Swale bed. Pretreatment can occur in a sediment forebay behind a check dam with a pipe inlet.

8.8.5.3 Vegetative Cover

Source: Metropolitan Council Environmental Services. 2001 *Minnesota Urban Small Sites BMP Manual*, St. Paul, MN.

- Species selection will depend upon the duration of water inundation, soil type, and amount of light. Desirable vegetative characteristics include species that form dense sod with vigorous, upright growth. Species that have tendencies to mat down should not be used when sediment filtering is the desired outcome.

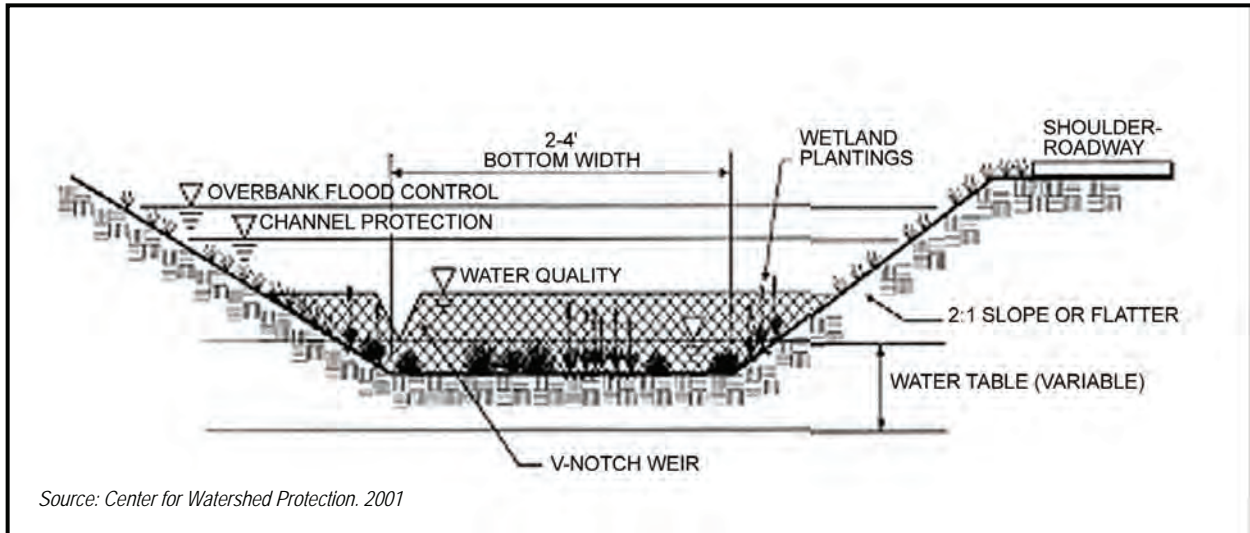

FIGURE 8.15 - Typical Wetland Swale Cross Section

- Specify plant species resistant to periodic inundation and periodic drought. Specify vegetation required to meet design condition (see **Appendix A**).
- Appropriate soil stabilization methods, such as mulch, blankets or mats should be used before the establishment of vegetation. Seeding, sodding, and other items related to establishing vegetation should be in accordance with accepted erosion-control and planning practices.

8.8.6 Maintenance and Inspections

Source: Metropolitan Council Environmental Services. 2001 *Minnesota Urban Small Sites BMP Manual*, St. Paul, MN.

The following is a partial list of actions to maintain Wetland Swales:

- Inspect Swale several times the first few months to ensure plant species are establishing well. If not, reseed or plant an alternative species. Also, inspect the channel for erosion after every rainfall event and repair as necessary.
- If a forebay is used, inspect and remove excessive sediment, trash, and debris and dispose of in an appropriate location.
- Control vegetation by mowing or grubbing techniques (not by chemicals).
- If heavy sediment loading occurs, clean the channel to remove excess material.

8.8.7 Design Example

To be completed at a later date.

8.9 BIOSWALES



Source: Georgia Stormwater Manual

Targeted Constituents

Sediment	●
Nutrients	◐
Trash	○
Metals	◐
Bacteria	◐
Oil and Grease	◐
Organics	◐

Legend (Removal Effectiveness)

High	Medium	Low
●	◐	○

8.9.1 Description

Bio-Swales are broad, shallow, natural, or constructed channels with a dense stand of vegetation covering the side slopes and channel bottom. They slowly convey stormwater runoff, and in the process promote infiltration, reduce flow velocities, and pretreat stormwater. Bio-Swales can have either parabolic or trapezoidal cross sections. Bio-Swales include an engineered soil matrix and an under-drain system for drainage.

8.9.2 General Application

Rather than routing stormwater runoff into a lined channel or into a curb-gutter system, consider using a natural conveyance channel. Bio-Swales promote infiltration, filter pollutants through an engineered media and through plant biological uptake. Do not use channels as a BMP component to convey deep concentrated flow; channels are only effective conveying shallow concentrated flow. Take care to identify the proper location for a Bio-Swale. Minimizing disturbance to the area (for example, avoiding application of pesticides and herbicides) maintains the channel's ability to remove contaminants. Select grass and plant species that tolerate low maintenance and can survive without significant human influence (see **Appendix A**).

8.9.3 Advantages

- Constructed less expensively and maintained more easily than underground pipes
- Underdrain system allows swale to remain dry most of the time and are desirable in residential settings.
- Improve water quality primarily by filtration through an engineered media. Pollutants are also removed through biological uptake.
- Reduce total volume of excess urban runoff to surrounding streams and rivers
- Minimize stream erosion by slowing the conveyance of water
- Enhance biological diversity and create beneficial habitat between upland and surface waters.

8.9.4 Disadvantages

- May not be feasible to implement after development has occurred
- Area requirements can be excessive for high-density development sites

- Not designed to be the fastest conveyance method and, therefore, require exact placement and design to minimize risk of flooding

8.9.5 Design Requirements and Considerations

To maximize pollutant removal efficiency, the time runoff is in contact with the vegetated swale should be maximized, and channelization of high flows should be avoided. This methodology is designed to treat the WQv through a volume-based design. If the wetland Swale is intended to convey flood flows in excess of the WQv, consult local ordinances for design criteria and freeboard requirements.

8.9.5.1 Shape and Slope

- The swales should generally be trapezoidal in shape, although a parabolic shape is also acceptable (provided the width is equal to or greater than the design bottom width for a trapezoidal cross section). The criteria presented in this section assume a trapezoidal cross section. **Figure 8.16** below illustrates a typical Bio-Swale section.
- For the trapezoidal cross section, size the bottom width between 2 and 8 feet. The 2-foot minimum allows for construction considerations and ensures a minimum filtering surface for water quality treatment. The 8-foot maximum reduces the likelihood of flow channelization within a portion of the swale.
- The side slopes of the channel should be no steeper than 3:1 for maintenance and safety considerations. Flatter slopes are encouraged where adequate space is available to aid in providing pretreatment for lateral flows.

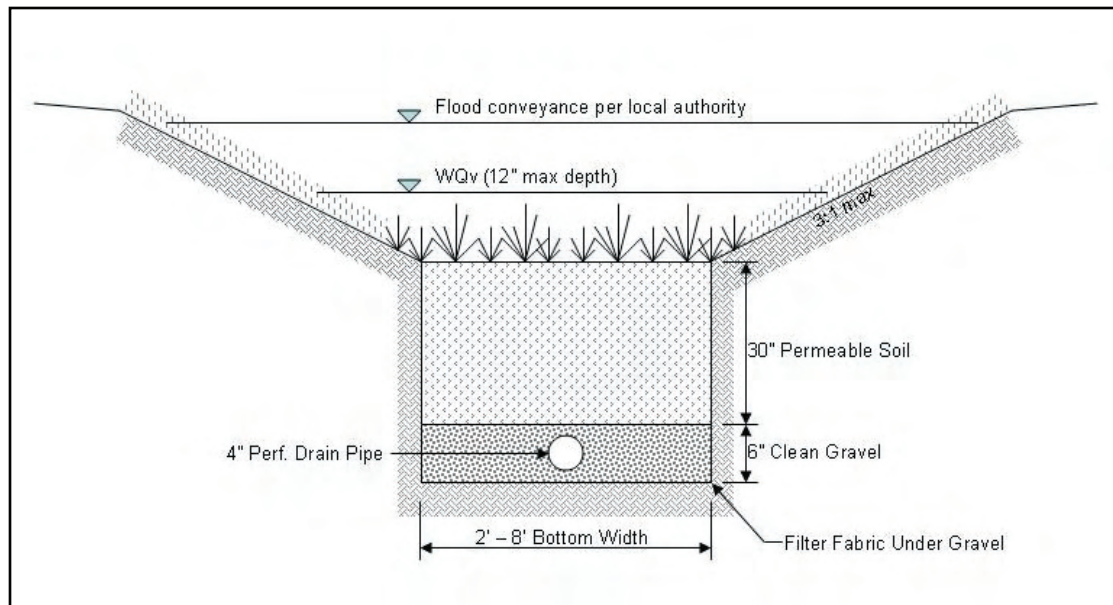

Figure 8.16 - Typical Bioswale Section

- Longitudinal slope between 1%-4% is recommended. When natural topography necessitates, steeper slopes may be acceptable if rock check dams (vertical drops of 6 to 12 inches) are used. These structures will require additional energy dissipating measures and should be placed no closer than 50 to 100 foot interval.

TABLE 8.6
Design Summary for Bio Swales

Parameter	Swale Design Criteria
Energy Dissipation	Required if piped inflow to swale
Pretreatment	Use forebay if high sediment load expected
Bottom Width	2 feet minimum, 8 feet maximum
Side Slopes	3:1 or flatter preferred
Longitudinal Slope	Up to 4% without check dams
Underlying soil bed	6" gravel with perforated underdrain pipe under 30" permeable soil
Sizing Criteria	Bio-Swales shall be sized to store and infiltrate the entire water quality volume (WQv) with less than 12" of ponding at any point in the swale with a maximum ponding time of 40 hours. Additional conveyance capacity and freeboard provided per local authority.
Erosion Protection	Width and slope shall be designed to ensure velocity of less than 5 fps in the 50% (2-year) discharge.

8.9.5.2 Design Procedure

- Compute the water quality runoff volume (WQv) and applicable flood conveyance discharges, as applicable per local criteria.
- Determine pretreatment volume. The forebay should be sized to contain 20% of the contributing WQv. The forebay storage volume counts toward the total WQv requirement and should be subtracted from the WQv for subsequent calculations.
- Determine Bio-Swale dimensions. Design swale to store and infiltrate the WQv with a maximum ponding depth of 12 inches and maximum ponding time of 40 hours. Design the bed of the swale to contain a permeable soil layer of at least 30 inches in depth, above a 4-inch diameter perforated PVC pipe (AASHTO M 252) longitudinal underdrain in a 6-inch gravel layer. The soil media should have an infiltration rate of at least 1 foot per day (1.5 feet per day maximum) and contain a high level of organic material to facilitate pollutant removal.
- Determine number of rock check dams necessary to store the WQv.
- Calculate the velocity and depth of flow through the swale using the 50% flow rate; maximum flow velocity shall not exceed 5.0 ft/s for erosion prevention. If these conditions are not attained, modify swale geometry, each time altering the depth, bottom width or longitudinal slopes until these criteria are satisfied.
- Provide bypass for high flows if the swale cannot be stable during the 10% or greater storm event.
- Check local criteria for flood conveyance and freeboard requirements.

- Use outlet protection at any discharge point from wetland swales to prevent scour at the outlet.
- The underdrain system should discharge to the storm drainage infrastructure or a stable outfall.

8.9.5.3 Vegetative Cover

- Species selection will depend upon the duration of water inundation, soil type, and amount of light. Desirable vegetative characteristics include species that form dense sod with vigorous, upright growth.
- Specify plant species resistant to periodic inundation and periodic drought. Specify vegetation required to meet design condition (see **Appendix A**).
- Appropriate soil stabilization methods, such as mulch, blankets or mats should be used before the establishment of vegetation. Seeding, sodding, and other items related to establishing vegetation should be in accordance with accepted erosion-control and planning practices.

8.9.5.4 Maintenance and Inspections

The following is a partial list of actions to upkeep Bio-Swales:

- Inspect swale several times the first few months to ensure plant species are establishing well. If not, reseed or plant an alternative species. Also, inspect the channel for erosion after every rainfall event and repair as necessary.
- If a forebay is used, inspect and remove excessive sediment, trash, and debris and dispose of in an appropriate location.
- Control vegetation by mowing or grubbing techniques (not by chemicals).
- If heavy sediment loading occurs, clean the channel to remove excess material.

8.10 EXTENDED WET DETENTION



Source: Tetra Tech, Inc.

Targeted Constituents

Sediment	●
Nutrients	◐
Trash	●
Metals	◐
Bacteria	◐
Oil and Grease	○
Organics	◐

Legend (Removal Effectiveness)

High	Medium	Low
●	◐	○

8.10.1 Description

Extended wet detention basins (EWDBs) are designed to collect stormwater runoff in a permanent pool and a temporary water quality pool during storm events (Urban Drainage and Flood Control District, 2005). The primary

removal mechanism is settling as stormwater runoff resides in this pool, but pollutant uptake, particularly of nutrients, also occurs to some degree through biological and chemical activity in the pond (California Stormwater Quality Association, 2003). In addition, a temporary detention volume is provided above this permanent pool to capture the water quality volume (WQv) and enhance sedimentation (Urban Drainage and Flood Control District, 2005).

EWDBs are similar to extended dry detention basins (EDDBs) because they are designed to capture runoff from frequently occurring storms. However, EWDBs differ from EDDBs because the influent water mixes with the permanent pool water as it rises above the permanent pool level. The surcharge captured volume above the permanent pool is then released over 40 hours (Urban Drainage and Flood Control District, 2005). EWDBs are also similar in function to constructed wetlands, and differ primarily in having a greater average depth (California Stormwater Quality Association, 2003).

EWDBs can be very effective in removing pollutants, and, under the proper conditions, can satisfy multiple objectives, including water quality improvement, flooding and erosion protection, creation of wildlife and aquatic habitats, and recreational and aesthetic provision (Urban Drainage and Flood Control District, 2005).

8.10.2 General Application

EWDBs can be used to improve stormwater runoff quality and reduce peak stormwater runoff rates and peak stages. An EWDB can be used to improve the quality of urban runoff from roads, parking lots, residential neighborhoods, commercial areas, and industrial sites, and is generally used to treat larger tributary areas than other best management practices (BMPs), or as follow-up treatment downstream of other BMPs. It can be used as an onsite BMP if the tributary area is sufficient to sustain a permanent pool. An EWDB works well in conjunction with other BMPs, such as upstream onsite source controls and downstream filter basins or wetland channels (Urban Drainage and Flood Control District, 2005). See treatment train **Figure 3.3**. An EWDB can also be designed to provide flood control benefits.

8.10.3 Advantages

- Because of the presence of the permanent wet pool, properly designed and maintained EWDBs can provide significant water quality improvement across a relatively broad spectrum of target constituents, including dissolved nutrients and many urban pollutants (California Stormwater Quality Association, 2003) (Urban Drainage and Flood Control District, 2005).
- Widespread application of EWDBs with sufficient capture volume and 40 hour water quality pool drawdown can provide significant control of channel erosion and enlargement caused by changes to flow frequency relationships resulting from the increase of impervious cover in a watershed (California Stormwater Quality Association, 2003).
- If properly designed, constructed, and maintained, EWDBs can provide substantial aesthetic/recreational value and wildlife and wetlands habitat (California Stormwater Quality Association, 2003).
- EWDBs can easily be designed to incorporate flood control volumes.
- EWDBs can be used for larger tributary areas.

8.10.4 Disadvantages

- The public can sometimes view EWDBs as a safety concern (California Stormwater Quality Association, 2003).
- Maintenance and sediment removal can be more difficult for EWDBs than it is for EDDBs because of the presence of the permanent pool. Possible additional maintenance concerns with an EWDB include floating litter, scum and algal blooms, nuisance odors, and aquatic plants blocking outlet works (Urban Drainage and Flood Control District, 2005).

-
- EWDBs require a permanent pool to function properly (California Stormwater Quality Association, 2003). These facilities may not be feasible in some locations because of insufficient tributary area to maintain the permanent pool.
 - If not properly designed and maintained, the permanent pool may attract large numbers of geese, which can add to the nutrient and fecal coliform loads entering and leaving the facility (Urban Drainage and Flood Control District, 2005).
 - In general, EWDBs can be more expensive and take more land than other BMPs (besides EDDBs).

8.10.5 Design Requirements and Considerations

The following guidelines are to be considered when designing EWDBs:

- EWDBs shall be designed as off-line facilities located outside of stream corridors and buffer areas to limit environmental impacts downstream when maintaining the facility.
- EWDBs shall have between 2 and 1,000 acres tributary to the facility (Kansas City Metropolitan Chapter of the American Public Works Administration, 2006).
- Design of the permanent pool volume should allow for 14 days hydraulic residence time to allow for particulate settling and nutrient uptake. This is accomplished by sizing the pool using regional precipitation data and characteristics of the tributary area to the EWDB. These considerations are illustrated in the design example at the end of this section (Metropolitan Nashville – Davidson County, 2000).
- The EWDB shall be designed to detain the WQv above the permanent pool. Additional flood control volume can also be provided above the permanent pool (Urban Drainage and Flood Control District, 2005). See APWA 5600 for design specifications if flood control is to be incorporated into the design of the EWDB.
- An impermeable liner may be required to maintain an adequate permanent pool level (California Stormwater Quality Association, 2003).
- The permanent pool shall include a littoral bench, or shelf, around the pool's perimeter. This bench serves as both a safety feature and a planting surface for wetland vegetation. The littoral bench shall extend inward at least 10 feet from the perimeter of the permanent pool and shall be between 6 inches to 12 inches below the permanent pool surface (California Stormwater Quality Association, 2003) (Urban Drainage and Flood Control District, 2005). The slope of the bench shall not exceed 6:1. The bench shall be planted with native wetland vegetation to promote biological uptake of nutrients and dissolved pollutants and reduce the formation of algal mats. To maximize biological uptake but prevent plants from encroaching on the open water surface, the vegetated littoral bench shall comprise 25 percent to 50 percent of the permanent pool surface area (Metropolitan Nashville – Davidson County, 2000).
- A sediment forebay shall be incorporated into the EWDB design to trap sediment and trash at all basin inlets, where the sediment and trash can be more easily removed than from the permanent pool (Kansas City Metropolitan Chapter of the American Public Works Administration, 2006). The forebay shall be at least 10 percent of the WQv and shall be 4 to 6 feet deep. These design criteria allow the forebay to function for longer periods between required sediment removal, possibly for up to 5 years. The use of a sediment forebay can extend the sediment removal interval from the permanent pool by 150 percent (Naval Facilities Engineering Service Center, 2004). The forebay consists of a separate cell, formed by an acceptable barrier such as a vegetated earthen weir, gabion, or loose riprap wall (California Stormwater Quality Association, 2003). To make sediment removal easier, the bottom and side slopes of the forebay may be lined with concrete (Urban Drainage and Flood Control District, 2005). Direct maintenance access shall be provided to the forebay.
- Inlet design considerations shall include energy dissipaters to reduce inflow velocity, scour potential, and the turbulence and mixing currents that disturb sedimentation (California Stormwater Quality Association, 2003).

-
- The EWDB outlet structure shall be designed to discharge the WQv over a period of 40 hours (Urban Drainage and Flood Control District, 2005). Refer to Section 6 of this manual for methodology to determine the WQv. When computer software is used to size the water quality outlet, a drawdown of 40 hours is reached when at least 90 percent of the WQv has exited the basin within 40 hours.
 - Locate basin outlet as far away from basin inlet(s) as possible to prevent water from short-circuiting the facility. The flow path(s) should have a minimum length of three times the facility width, as measured across the center of the facility in the smallest dimension at the permanent pool elevation (Metropolitan Nashville – Davidson County, 2000).
 - Permanent pool depths optimally range from 4 feet to 6 feet, and shall be no greater than 12 feet (California Stormwater Quality Association, 2003). The minimum depth of 4 feet shall be provided in addition to an estimated depth of sediment accumulation from 5 years of EWDB service. Annual sediment accumulation depth can be estimated based on characteristics of the tributary area to the facility. This estimate is illustrated in the design example at the end of this section (Kansas City Metropolitan Chapter of the American Public Works Administration, 2006). This minimum depth requirement prevents vegetation from encroaching on the pond open water surface. The maximum mean depth of 12 feet prevents thermal stratification that can result in potential nutrient release problems associated with anaerobic conditions (Metropolitan Nashville – Davidson County, 2000). If the facility is to contain fish, at least one-quarter of the area of the permanent pool must have a minimum depth of 10 feet plus a sedimentation allowance (Kansas City Metropolitan Chapter of the American Public Works Administration, 2006).
 - Side slopes above the littoral bench shall be 4:1 (H:V) or flatter unless retaining walls are used. Side slopes below the littoral bench can be as steep as 3:1 to maximize permanent pool volumes where needed (Metropolitan Nashville – Davidson County, 2000).
 - The sides of earthen berms and walls shall be vegetated with native vegetation to prevent erosion (Metropolitan Nashville – Davidson County, 2000).
 - Do not locate EWDBs on fill sites or on or near steep slopes if it is expected that much of the water will exit through the bottom of the facility, unless the bottom of the facility is modified to prevent excessive infiltration. Depending on soils, bottom modifications can include compaction, incorporating clay into the soil, or an artificial liner (Metropolitan Nashville – Davidson County, 2000).
 - Erosion protection shall be placed at the facility's outfall. Energy dissipation may be required to reduce flow velocities from the primary spillway to nonerosive values (California Stormwater Quality Association, 2003).
 - A maintenance ramp and perimeter access shall be included in the design to facilitate access to the basin for maintenance activities (California Stormwater Quality Association, 2003). A 15-foot-wide access strip, with slopes less than 5:1 (H:V) shall be provided around the perimeter of the facility, unless it can be demonstrated that all points of the facility can be maintained with less access provided. The property owner shall also maintain a minimum 15-foot-wide access route to the facility from a street or parking lot (Kansas City Metropolitan Chapter of the American Public Works Administration, 2006).
 - The maximum water surface shall be a minimum of 20 feet from property lines and building structures. A greater distance may be necessary when the detention facility might compromise foundations or slope stability is a consideration (Kansas City Metropolitan Chapter of the American Public Works Administration, 2006).
 - Ponds that serve smaller local site runoff do not offer as much recreational benefit as ponds serving larger tributary areas. Larger facilities can often be landscaped to offer recreational and aesthetic benefits. Jogging and walking trails, picnic areas, ball fields, and canoeing or boating are some of the typical uses. For example, portions of the facility used for flood control can be kept dry, except during floods, and can be used for exercise areas, soccer fields, or football fields. Wildlife benefits can also be provided in the form of

islands or preservation zones, which allow a view of nature within the park schemes (Metropolitan Nashville – Davidson County, 2000).

- Bedrock must be considered because excavation may be required for grading of a permanent pool. The cost to excavate into bedrock will be significantly higher than the cost to excavate soil. Furthermore, if there is highly fractured bedrock or karst topography, then the siting of an EWDB should be carefully considered because it may not hold water and the additional water flow and/or weight could intensify karst activity (Metropolitan Nashville – Davidson County, 2000).
- EWDBs that do not provide flood storage for the 1 percent storm shall be designed so that runoff flows from the 1 percent event safely pass through the facility. At a minimum, all facility embankments shall be protected from failure during the 1 percent event. An emergency spillway, which conveys large flood flows safely past earth embankments, must be provided for each dam, unless the principal spillway is large enough to pass the peak flow expected from the 1 percent design storm without overtopping the dam (Natural Resources Conservation Service – Maryland, 2000).
- Outflow structures shall be protected by well screen, trash racks, grates, stone filters, submerged inlet pipes to the outflow structure, or other approved devices to ensure that the outlet works will remain functional (Kansas City Metropolitan Chapter of the American Public Works Administration, 2006). No single outlet orifice shall be less than 4 inches in diameter (smaller orifices are more susceptible to clogging). If the calculated orifice diameter necessary to achieve a 40-hour drawdown is less than 4 inches, a perforated riser, orifice plate, or v-notch weir shall be used instead of a single orifice outlet. Keep perforations larger than 1 inch when using orifice plates or perforated risers. Smaller orifice sizes may be used if the weir plate is placed in a riser manhole in a sump-like condition.
- A reverse-slope pipe can be used to prevent outlet clogging from debris. A reverse-slope pipe draws from below the permanent pool extending in a reverse angle up to the riser and establishes the water elevation of the permanent pool. Because these outlets draw water from below the level of the permanent pool, they are less likely to be clogged by floating debris (California Stormwater Quality Association, 2003).
- All pipes through material subject to saturation within earth embankments, regardless of their designated purposes, shall be fitted with watertight cutoff collars or other accepted means of controlling seepage. Such collars shall be of sufficient size and number so as to increase the length of the seepage path along the pipe by at least 15 percent. Spacing between collars shall be 20 to 25 feet. When a single collar is to be used, it shall be placed on the pipe near the point where the centerline of the dam intersects the pipe. If two or more collars are to be installed, they shall generally be placed within the middle third of the pipe length. Generally, such collars should project a minimum of 2 feet beyond the outside of the pipe, regardless of pipe size, and should be no closer than 2 feet to a field joint (Kansas State Board of Agriculture, Division of Water Resources, 1986).
- The facility shall have a separate drain pipe with a manual valve that can completely drain the pond for maintenance purposes. To allow for possible sediment accumulation, the submerged end of the pipe shall be protected, and the drain pipe shall be sized to drain the pond within 24 hours (California Stormwater Quality Association, 2003). The valve shall be located at a point where it can be operated in a safe and convenient manner at all times. Complete gravity drawdown may be impossible for excavated ponds, and a pump may be required to drain the permanent pool.
- Design EWDBs to deter large numbers of geese from gathering in the facility. Geese can add to the nutrient and fecal coliform loads entering and leaving the facility. Planting a buffer of trees, shrubs, and native ground cover around the EWDB can help discourage resident geese populations.
- Public safety shall be considered in EWDB design. Fences and landscaping can be used to impede access to the facility. The facility shall be contoured so as to eliminate any dropoffs or other hazards. The primary spillway opening must not permit access by small children. Outfall pipes above 48 inches in diameter shall

be fenced (California Stormwater Quality Association, 2003). When possible, terraces or benches shall be used to transition into the permanent pool. In some cases there is not sufficient room for grading of this type and the pond may require a perimeter fence (Metropolitan Nashville – Davidson County, 2000).

- Reference Section 44 Additional Practices for Hot Spots for facilities that receive stormwater from contributing areas that have high potential for oil and grease contamination.
- Dams that are greater than 10 feet in height but do not fall into state or federal requirement categories shall be designed in accordance with the latest edition of SCS Technical Release No. 60, Earth Dams and Reservoirs, as Class C structures (Kansas City Metropolitan Chapter of the American Public Works Administration, 2006).
- To maintain a permanent pool, the tributary area to the EWDB should be at least 5.5 acres for each acre-foot of permanent pool volume and at least 10.3 acres for each acre of permanent pool surface area. Table 8.7 presents threshold tributary areas for different Rational C values.

8.10.6 Maintenance and Inspections

The success of an EWDB as a mechanism to benefit water quality is dependent on maintaining the permanent pool, vegetation, skimmer devices (where employed), and inlet and outlet structures. Key maintenance operations include sediment, floatable, and debris removal from inlets, outlets, and skimmers (Metropolitan Nashville – Davidson County, 2000).

Since EWDBs are often selected for their aesthetic considerations as well as pollutant removal, they are often sited in areas of high visibility. Consequently, floating litter and debris may be removed more frequently than would be required simply to support proper functioning of the basin and outlet. EWDBs in highly visible settings should be checked weekly and after every large storm event for floating litter and debris. The frequency with which litter and debris must be removed to maintain aesthetics will vary based on the land use of the contributing area to the facility. The inspection schedule can be altered once aesthetic maintenance requirements are established for a particular site. Vegetation management in the area surrounding the EWDB can also contribute substantially to the overall maintenance requirements (California Stormwater Quality Association, 2003).

Typical activities and frequencies include:

- Inspect the facility semiannually for burrows, sediment accumulation, structural integrity of the outlet, and litter accumulation (California Stormwater Quality Association, 2003). The banks of the EWDB should be checked and areas of erosion repaired. Remove sediments if they are within 18 inches of an outlet opening (Metropolitan Nashville – Davidson County, 2000).
- Trim or harvest vegetation as appropriate to maintain water quality, maintenance access, and aesthetics. Once vegetation reaches maximum density in an EWDB, vegetative growth may slow and consequently so will nutrient uptake. Routine vegetation harvesting may increase a facility's nutrient removal efficiency by providing room for new vegetation to grow. Regular harvesting also prevents outlets from clogging, and the export of nutrients and storage volume reduction from dead and dying plants falling in the water (California Stormwater Quality Association, 2003). Harvested vegetation should be disposed of in a composting facility, yard waste processing center, or landfill. Harvested vegetation shall not be allowed to re-enter the EWDB or downstream water bodies as it would add to the nutrient load.
- Check outlet after each storm event greater than 0.5 inches for clogging and remove any debris.
- Grassy areas shall be mowed annually, unless the unchecked growth of native grass banks interferes with multiuse objectives. Repairs shall be made to signage, walkways, picnic tables, or any other public recreation equipment as needed. If both the operational and aesthetic characteristics of an EWDB are not maintained, then it will be viewed as an eyesore and negative environmental impact even if it is functioning properly (Metropolitan Nashville – Davidson County, 2000).

-
- Remove sediment when 10 percent to 15 percent of the EWDB permanent pool has been lost. A probing rod can be used to indicate when sediment has reached the depth corresponding to 10 percent to 15 percent of the permanent pool volume (Metropolitan Nashville - Davidson County, 2000).
 - Sediment shall be removed when 50 percent of the forebay capacity is silted (Naval Facilities Engineering Service Center, 2004).

8.10.6.1 Sediment Removal

- Some sediment may contain contaminants of which the Kansas Department of Health and Environment (KDHE) or Missouri Department of Natural Resources (MDNR) requires special disposal procedures. If there is any uncertainty about what the sediment contains or it is known to contain contaminants, then KDHE or MDNR should be consulted and their disposal recommendations followed. Sampling and testing shall be performed on sediments accumulated in facilities serving industrial, manufacturing or heavy commercial sites, fueling centers or automotive maintenance areas, large parking areas, or other areas where pollutants (other than "clean" soil) are suspected to accumulate and be conveyed via stormwater runoff (Metropolitan Nashville – Davidson County, 2000).
- Some sediment collected may be innocuous (free of pollutants other than "clean" soil) and can be used as fill material, cover, or land spreading. It is important that this material not be placed in a way that will promote or allow resuspension in stormwater runoff. The sediment should not be placed within the high water level area of the EWDB, other BMP, creek, waterway, buffer, runoff conveyance device, or other infrastructure. Some demolition or sanitary landfill operators will allow the sediment to be disposed at their facility for use as cover if testing ensures that the sediment is innocuous (Metropolitan Nashville – Davidson County, 2000).

8.10.7 Design Example

The following sections present an example for designing an EWDB. These procedures follow the steps outlined in the Design Procedure Form: Extended Wet Detention Basin (EWDB) Main Worksheet. When using the worksheet in electronic form, manually enter values in green.

8.10.7.1 Example

You are designing an extended wet detention basin to treat stormwater runoff from a 100-acre tributary area that is developed for mixed use, including a shopping center and medium- and high-density residential areas. Size the permanent pool and WQVs of the basin and incorporate an outlet structure that will release the WQv over a period of 40 hours.

I. Basin Water Quality Volume

Step 1- Enter the tributary area to the EWDB (A_T).

Step 2- Calculate the WQv using the methodology presented in Section 6 of this manual.

Ila. Permanent Pool Volume, Method 1 (Florida Department of Environmental Regulation, 1988)

This method calculates the permanent pool volume required to provide a minimum detention time of 14 days to allow sufficient time for the uptake of dissolved phosphorus by algae and the settling of fine solids where the particulate phosphorus tends to be concentrated.

Step 1- Enter the average 14-day wet season rainfall (R_{14}). Based on the period of record for Kansas City, this is 2.2 inches.

Step 2- Determine the Rational runoff coefficient (C) for the tributary area. This value can be obtained from APWA Section 5602.3 or estimated by delineating pervious and impervious components of the tributary area:

$$C = 0.3 + 0.6 * I; I = \text{percent impervious area divided by 100}$$

Step 3- Calculate the permanent pool volume (V_{P1}) from the runoff coefficient, tributary area, and average 14-day wet season rainfall:

$$V_{P1} = (C * A_T * R_{14})/12$$

IIb. Permanent Pool Volume, Method 2 (EPA, 1986)

This method calculates the permanent pool volume required to settle out suspended solids to the basin bottom.

Step 1- Select the WQv/runoff volume ratio ($V_{B/R}$) from **Figure 8.6**, based on desired total suspended solids (TSS) removal efficiency. This ratio should be at least 4.

Step 2- Determine the mean storm depth (S_d) for your region. For the Kansas City area, this depth is 0.6 inches.

Step 3- Calculate the total impervious tributary area (A_i) to the EWDB in acres.

Step 4- Calculate the permanent pool volume (V_{P2}) from the values determined in Steps 1, 2, and 3:

$$V_{P2} = (V_{B/R} * S_d * A_i)/12$$

IIc. Permanent Pool Design Volume

Step 1- Choose the larger of two permanent pool volumes calculated in Parts IIa and IIb and add 20% to account for sedimentation. This value is the design volume (V_p) for the permanent pool.

Step 2- Set desired average permanent pool depth (Z_p). This depth should be between 4 feet and 6 feet, unless the pond is being stocked with fish. This average depth should include all parts of the EWDB inundated by the permanent pool, including the littoral bench (Part VI).

Step 3- Calculate the required permanent pool surface area (A_{PP}) to accommodate the permanent pool volume calculated in Step 1. This surface area will include the littoral bench (Part VI).

IIIa. Water Quality Outlet Type

Step 1- Select type of water quality outlet.

Step 2- Proceed to Part IIIb, IIIc, or IIId based on water quality outlet type selected in Step 1.

IIIb. Water Quality Outlet, Single Orifice (City of Knoxville, 2001)

Step 1- Set depth above WQv outlet (Z_{WQ}) based on required WQv and desired facility dimensions (surface area, depth). Facility dimensions should be designed to conform to specific site constraints.

Step 2- Calculate the average head of the WQv over the orifice invert (H_{WQ}) as $\frac{1}{2}$ the WQv depth:

$$H_{WQ} = 0.5 * Z_{WQ}$$

Step 3- Calculate the average water quality outflow rate (Q_{WQ}) that would result in the entire WQv draining over a period of 40 hours:

$$Q_{WQ} = (WQv * 43,560)/(40 * 3,600)$$

Step 4- Set the value of the orifice discharge coefficient (C_o) based on orifice geometry and thickness of riser/weir plate.

Step 5- Calculate the required water quality outlet orifice diameter (D_o) from parameters determined in Steps 2, 3, and 4. Orifice diameter should be larger than 0.5 inches to reduce the chance for clogging.

$$D_o = 12 * 2 * (Q_{WQ}/(C_o * \pi * (2 * g * H)^{0.5}))^{0.5}$$

Step 6- To size a single water quality outlet orifice for an EWDB with an irregular stage-volume relationship, use the Single Orifice Worksheet. Fill in the first column with cumulative volume values for each depth interval. The Single Orifice Worksheet uses values from Part IIIb of the Main Worksheet.

IIIc. Water Quality Outlet, Perforated Riser or Plate (Urban Drainage and Flood Control District, 2005)

Step 1 - Set depth above WQv outlet (Z_{WQ}) based on required WQv and desired facility dimensions (surface area, depth). Facility dimensions should be designed to conform to specific site constraints.

Step 2 - Calculate the recommended maximum outlet area per row of perforations (A_o) based on the WQv and the depth at the basin outlet:

$$A_o = WQv / (0.013 * Z_{WQ}^2 + 0.22 * Z_{WQ} - 0.10)$$

Step 3- Assuming a single column, calculate the diameter of a single circular perforation (D_1) for each row based on the outlet area calculated in Step 2.

Step 4 - Set the number of columns of perforations (n_c). Keep this number as low as possible, optimally 1. If the diameter calculated in Step 3 is greater than 2 inches, make the number of columns greater than 1.

Step 5 - Calculate the design circular perforation diameter (D_{perf}) based on the area calculated in Step 2 and the number of columns set in Step 4. Iteratively increase the number of columns until this design diameter is between 1 and 2 inches.

Step 6 - Calculate the horizontal perforation column spacing (S_c), center to center, when the number of columns is greater than 1. As long as the perforation diameter calculated in Step 5 is greater than 1, the horizontal perforation column spacing should be 4 inches.

Step 7 - Calculate the number of rows of perforations (n_r), center to center, based on a 4-inch vertical spacing and depth at outlet from Step 1.

IIIId. Water Quality Outlet, V-Notch Weir (City of Knoxville, 2001)

Step 1 - Set depth above WQv outlet (Z_{WQ}) based on required WQv and desired facility dimensions (surface area, depth). Facility dimensions should be designed to conform to specific site constraints.

Step 2 - Calculate the average head of the WQv over the v-notch invert (H_{WQ}) as $\frac{1}{2}$ the WQv depth:

$$H_{WQ} = 0.5 * Z_{WQ}$$

Step 3- Calculate the average water quality outflow rate (Q_{WQ}) that would result in the entire WQv draining over a period of 40 hours:

$$Q_{WQ} = (WQv * 43,560) / (40 * 3,600)$$

Step 4- Set the value of the v-notch weir discharge coefficient ($C_v = 2.5$ typical).

Step 5- Calculate the required v-notch weir angle (θ) from parameters determined in Steps 2, 3, and 4. If the calculated v-notch weir angle is less than 20 degrees, set to 20 degrees.

$$\theta = 2 * (180/\pi) * \arctan(Q_{WQ} / (C_v * H_{WQ}^{5/2}))$$

Step 6- Calculate the top width of the v-notch weir (W_v):

$$W_v = 2 * Z_{WQ} * \text{TAN}(\theta/2)$$

Step 7- To size a v-notch weir for an EWDB with an irregular stage-volume relationship, use the V-Notch Weir Worksheet. Fill in the first column with cumulative volume values for each depth interval. The V-Notch Weir Worksheet uses values from Part IIIId of the Main Worksheet.

IV. Trash Racks (Urban Drainage and Flood Control District, 2005)

Step 1- Calculate the total water quality outlet area (A_{ot}) from IIIb, IIIc, or III d, whichever outlet configuration you selected.

Step 2- Calculate the required trash rack open area (A_t) from the total outlet area. **Figures 8.17 and 8.18** show suggested details for trash racks over perforated riser outlets.

$$A_t = A_{ot} * 77 * e^{(-0.124 * D)} \text{ for single orifice outlet}$$

$$A_t = (A_{ot}/2) * 77 * e^{(-0.124 * D)} \text{ for orifice plate or perforated riser outlet}$$

$$A_t = 4 * A_{ot} \text{ for v-notch weir outlet}$$

V. Forebay (Urban Drainage and Flood Control District, 2005)

Step 1 - Forebay volume (Vol_{FB}) should equal at least 10 percent of the WQv calculated in Part I, Step 2.

Step 2 - Set the forebay depth (Z_{FB}) as at least 3 feet deep.

Step 3 - Calculate the minimum forebay surface area (A_{FB}) from the volume in Step 1 and depth in Step 2.

Step 4 - Ensure that the sides and bottom of the forebay are paved or hardened to ease removal of silt and sedimentation from the forebay.

VI. Littoral Bench (Urban Drainage and Flood Control District, 2005)

Step 1 - Littoral bench should comprise between 25 percent and 50 percent of the total permanent pool surface area calculated in Part IIc, Step 3.

Step 2- Estimate minimum and maximum littoral bench widths based on areas calculated in Step 1. Bench width should be at least 10 feet.

Step 3 - Set desired bench width (W_{LB}) within range calculated in Step 2.

Step 4 - Set the bench depth (Z_{LB}) between 6 inches and 12 inches below the permanent pool surface.

VII. Basin Side Slopes (Urban Drainage and Flood Control District, 2005)

Basin side slopes should be at least 4:1 (H:V) to facilitate maintenance and public safety. Side slopes should be stabilized, preferably with native vegetative cover.

VIII. Dam Embankment Side Slopes (Urban Drainage and Flood Control District, 2005) (Kansas State Board of Agriculture, Division of Water Resources, 1986)

Dam embankment side slopes should be at least 3:1 (H:V) for public safety. Embankment soils should be compacted to at least 95 percent of their maximum density according to ASTM D 698-70 (Modified Proctor). Embankment slopes should be planted with turf forming grasses. Earth dam designs shall comply with all requirements set forth in the Kansas State Board of Agriculture Division of Water Resources *Engineering Guide – 2*.

IX. Vegetation (Urban Drainage and Flood Control District, 2005)

Basin berms and side slope areas should be planted with native grasses or with irrigated turf to provide erosion control, depending on the local setting and needs. Littoral bench should be planted with native wetland species to promote biological uptake of nutrients. Refer to suggestions and guidelines in **Appendix A** for vegetation selection and planting design.

X. Inlet Protection (Urban Drainage and Flood Control District, 2005)

Dissipate flow energy at basin's inflow point(s) to limit erosion and promote particle sedimentation.

XI. Access (Urban Drainage and Flood Control District, 2005)

All-weather stable access to the bottom, forebay, littoral bench, and outlet works area shall be provided for maintenance vehicles. Grades should not exceed 10 percent along access paths, and a solid driving surface of gravel, rock, concrete, or gravel-stabilized turf should be provided.

Table 8.7
Threshold Tributary Areas to EWDB

	Rational Runoff Coefficient, C							
	0.3	0.4	0.5	0.6	0.7	0.8	0.9	1.0
Minimum Tributary Area per Acre-Foot of Volume	18.4	13.8	11.0	9.2	7.9	6.9	6.1	5.5
Minimum Tributary Area per Acre of Surface Area	34.2	25.7	20.5	17.1	14.7	12.8	11.4	10.3

**Design Procedure Form: Extended Wet Detention Basin (EWDB)
Main Worksheet**

Designer: _____
Checked By: _____
Company: _____
Date: _____
Project: _____
Location: _____

<u>I. Basin Water Quality Volume</u>	
Step 1) Tributary area to EWDB, A_T (ac)	A_T (ac) = <u>100.0</u>
Step 2) Calculate WQv using methodology in Section 6	WQv (ac-ft) = <u>6.23</u>
<u>IIa. Permanent Pool Volume, Method</u>	
Step 1) Average 14 day wet season rainfall, R_{14} (in)	R_{14} (in) = <u>2.2</u>
Step 2) Rational runoff coefficient, C $C = 0.3 + 0.6 * I$ I = percent impervious area divided by 100	C = <u>0.6</u>
Step 3) Permanent pool volume by Method 1, V_{P1} (ac-ft) $V_{P1} = (C * A_T * R_{14})/12$	V_{P1} (ac-ft) = <u>11.0</u>
<u>IIb. Permanent Pool Volume, Method</u>	
Step 1) Ratio of basin volume to runoff volume, $V_{B/R}$ (from Figure 12; $V_{B/R}$ should be ≥ 4.0)	$V_{B/R}$ = <u>5.0</u>
Step 2) Mean storm depth, S_d (in)	S_d (in) = <u>0.60</u>
Step 3) Impervious tributary area, A_I (ac)	A_I (ac) = <u>57</u>
Step 4) Permanent pool volume by Method 2, V_{P2} (ac-ft) $V_{P2} = (V_{B/R} * S_d * A_I)/12$	V_{P2} (ac-ft) = <u>14.25</u>
<u>IIc. Permanent Pool Design Volume</u>	
Step 1) Design permanent pool volume, V_P , as larger of volumes calculated in IIa and IIb plus 20%	V_P (ac-ft) = <u>17.10</u>
Step 2) Average permanent pool depth, Z_P (ft)	Z_P (ft) = <u>5.0</u>
Step 3) Permanent pool surface area, A_P (ac)	A_P (ac) = <u>3.42</u>

IIIa. Water Quality Outlet Type

Step 1) Set water quality outlet type:

- Type 1 = single orifice
- Type 2 = perforated riser or plate
- Type 3 = v-notch weir

Outlet Type = 1

Step 2) Proceed to part IIIb, IIIc, or IIId based on water quality outlet type selected

IIIb. Water Quality Pool Outlet, Single Orifice

Step 1) Depth of water quality volume above permanent pool, Z_{WQ} (ft)

Z_{WQ} (ft) = 3.0

Step 2) Average head of water quality volume over invert of orifice, H_{WQ} (ft)

$$H_{WQ} = 0.5 * Z_{WQ}$$

H_{WQ} (ft) = 1.5

Step 3) Average water quality outflow rate, Q_{WQ} (cfs)

$$Q_{WQ} = (WQV * 43,560) / (40 * 3,600)$$

Q_{WQ} (cfs) = 1.88

Step 4) Set value of orifice discharge coefficient, C_o

- $C_o = 0.66$ when thickness of riser/weir plate is = or < orifice diameter
- $C_o = 0.80$ when thickness of riser/weir plate is > orifice diameter

C_o = 0.66

Step 5) Water quality outlet orifice diameter (minimum of 1/2 inch), D_o (in)

$$D_o = 12 * 2 * (Q_{WQ} / (C_o * \pi * (2 * g * H)^{0.5}))^{0.5}$$

(If orifice diameter < 4 inches, use outlet type 2 or 3)

D_o (in) = 7.3

Step 6) To size outlet orifice for EWDB with an irregular stage-volume relationship, use the Single Orifice Worksheet

IIIc. Water Quality Outlet, Perforated Riser

Step 1) Depth of water quality volume above permanent pool, Z_{WQ} (ft)

Z_{WQ} (ft) = 3.0

Step 2) Recommended maximum outlet area per row, A_o (in²)

$$A_o = WQV / (0.013 * Z_{WQ}^2 + 0.22 * Z_{WQ} - 0.10)$$

A_o (in²) = 9.2

Step 3) Circular perforation diameter per row assuming a single column, D_1 (in)

D_1 (in) = 3.42

Step 4) Number of columns, n_c

n_c = 3

Step 5) Design circular perforation diameter (between 1 and 2 inches), D_{perf} (in)

D_{perf} (in) = 1.98

Step 6) Horizontal perforation column spacing when $n_c > 1$, center to center, S_c

$$\text{If } D_{perf} \geq 1.0 \text{ in, } S_c = 4$$

S_c (in) = 4

Step 7) Number of rows (4" vertical spacing between perforations, center to center), n_r

n_r = 9

IIIId. Water Quality Outlet, V-Notch Weir⁶

Step 1) Depth of water quality volume above permanent pool, Z_{WQ} (ft)	Z_{WQ} (ft) =	<u>3.0</u>
Step 2) Average head of water quality pool volume over invert of v-notch, HWQ (ft) $H_{WQ} = 0.5 * Z_{WQ}$	H_{WQ} (ft) =	<u>1.5</u>
Step 3) Average water quality pool outflow rate, Q_{WQ} (cfs) $Q_{WQ} = (WQv * 43,560)/(40 * 3,600)$	Q_{WQ} (cfs) =	<u>1.88</u>
Step 4) V-notch weir coefficient, C_v	C_v =	<u>2.5</u>
Step 5) V-notch weir angle, θ (deg) $\theta = 2 * (180/\pi) * \arctan(Q_{WQ}/(C_v * H_{WQ}^{5/2}))$ V-notch angle should be at least 20 degrees. Set to 20 degrees if calculated angle is smaller.	θ (deg) =	<u>31</u>
Step 6) V-notch weir top width, W_v (ft) $W_v = 2 * Z_{WQ} * \text{TAN}(\theta/2)$	W_v (ft) =	<u>1.6</u>
Step 7) To calculate v-notch angle for EWDB with an irregular stage-volume relationship, use the V-notch Weir Worksheet		

IV. Trash Racks

Step 1) Total outlet area, A_{ot} (in ²)	A_{ot} (in ²) =	<u>42</u>
Step 2) Required trash rack open area, A_t (in ²) $A_t = A_{ot} * 77 * e^{(-0.124 * D)}$ for single orifice outlet $A_t = (A_{ot}/2) * 77 * e^{(-0.124 * D)}$ for orifice plate or perforated riser outlet $A_t = 4 * A_{ot}$ for v-notch weir outlet	A_t (in ²) =	<u>1,303</u>

V. Forebay

Step 1) Volume should equal at least 10% of WQv	Min Vol _{FB} (ac-ft) =	<u>0.62</u>
Step 2) Forebay depth, Z_{FB} (ft)	Z_{FB} (ft) =	<u>3.0</u>
Step 3) Minimum forebay surface area, A_{FB} (ac)	Min A_{FB} (ac) =	<u>0.21</u>
Step 4) Paved/hard bottom and sides?		<u>Yes</u>

VI. Littoral Bench

Step 1) Littoral bench should be 25% - 50% of the permanent pool surface area
Min A_{LB} (ac) = 0.86
Max A_{LB} (ac) = 1.71

Step 2) Approximate minimum and maximum bench widths, assuming circular permanent pool
Min W_{LB} (ft) = 27
Max W_{LB} (ft) = 54

Step 3) Design bench width around perimeter of EWDB, W_{LB} (ft) W_{LB} (ft) = 30

Step 4) Bench depth below permanent pool surface, Z_{LB} (ft) Z_{LB} (ft) = 0.5 - 1.0

VII. Basin side slopes

Basin side slopes should be at least 4:1 (H:V) Side Slope (H:V) = 4.0

VIII. Dam Embankment side slopes

Dam Embankment side slopes should be at least 3:1 (H:V) Dam Embankment (H:V) = 3.0

IX. Vegetation

Check the method of vegetation planted in the EWDB or describe "other"
 Native Grass
 Irrigated Turf Grass
 Native Aquatic Species
Other: _____

X. Inlet Protection

Indicate method of inlet protection/energy dissipation at EWDB inlet Rip-rap apron

**Design Procedure Form: Extended Wet Detention Basin (EWDB)
Main Worksheet**

Designer: _____
Checked By: _____
Company: _____
Date: _____
Project: _____
Location: _____

<u>I. Basin Water Quality Volume</u>	
Step 1) Tributary area to EWDB, A_T (ac)	A_T (ac) = _____
Step 2) Calculate WQv using methodology in Section 6	WQv (ac-ft) = _____
<u>IIa. Permanent Pool Volume, Method</u>	
Step 1) Average 14 day wet season rainfall, R_{14} (in)	R_{14} (in) = _____
Step 2) Rational runoff coefficient, C $C = 0.3 + 0.6 * I$ $I = \text{percent impervious area divided by 100}$	C = _____
Step 3) Permanent pool volume by Method 1, V_{P1} (ac-ft) $V_{P1} = (C * A_T * R_{14})/12$	V_{P1} (ac-ft) = _____
<u>IIb. Permanent Pool Volume, Method</u>	
Step 1) Ratio of basin volume to runoff volume, $V_{B/R}$ (from Figure 12; $V_{B/R}$ should be ≥ 4.0)	$V_{B/R}$ = _____
Step 2) Mean storm depth, S_d (in)	S_d (in) = _____
Step 3) Impervious tributary area, A_I (ac)	A_I (ac) = _____
Step 4) Permanent pool volume by Method 2, V_{P2} (ac-ft) $V_{P2} = (V_{B/R} * S_d * A_I)/12$	V_{P2} (ac-ft) = _____
<u>IIc. Permanent Pool Design Volume</u>	
Step 1) Design permanent pool volume, V_P , as larger of volumes calculated in IIa and IIb plus 20%	V_P (ac-ft) = _____
Step 2) Average permanent pool depth, Z_P (ft)	Z_P (ft) = _____
Step 3) Permanent pool surface area, A_P (ac)	A_P (ac) = _____

IIIa. Water Quality Outlet Type

Step 1) Set water quality outlet type: Outlet Type = _____
Type 1 = single orifice
Type 2 = perforated riser or plate
Type 3 = v-notch weir

Step 2) Proceed to part IIIb, IIIc, or IIId based on water quality outlet type selected

IIIb. Water Quality Pool Outlet, Single Orifice

Step 1) Depth of water quality volume above permanent pool, Z_{WQ} (ft) Z_{WQ} (ft) = _____

Step 2) Average head of water quality volume over invert of orifice, H_{WQ} (ft) H_{WQ} (ft) = _____
 $H_{WQ} = 0.5 * Z_{WQ}$

Step 3) Average water quality outflow rate, Q_{WQ} (cfs) Q_{WQ} (cfs) = _____
 $Q_{WQ} = (WQV * 43,560) / (40 * 3,600)$

Step 4) Set value of orifice discharge coefficient, C_o C_o = _____
 $C_o = 0.66$ when thickness of riser/weir plate is = or < orifice diameter
 $C_o = 0.80$ when thickness of riser/weir plate is > orifice diameter

Step 5) Water quality outlet orifice diameter (minimum of 1/2 inch), D_o (in) D_o (in) = _____
 $D_o = 12 * 2 * (Q_{WQ} / (C_o * \pi * (2 * g * H)^{0.5}))^{0.5}$
(If orifice diameter < 4 inches, use outlet type 2 or 3)

Step 6) To size outlet orifice for EWDB with an irregular stage-volume relationship, use the Single Orifice Worksheet

IIIc. Water Quality Outlet, Perforated Riser

Step 1) Depth of water quality volume above permanent pool, Z_{WQ} (ft) Z_{WQ} (ft) = _____

Step 2) Recommended maximum outlet area per row, A_o (in²) A_o (in²) = _____
 $A_o = WQV / (0.013 * Z_{WQ}^2 + 0.22 * Z_{WQ} - 0.10)$

Step 3) Circular perforation diameter per row assuming a single column, D_1 (in) D_1 (in) = _____

Step 4) Number of columns, n_c n_c = _____

Step 5) Design circular perforation diameter (between 1 and 2 inches), D_{perf} (in) D_{perf} (in) = _____

Step 6) Horizontal perforation column spacing when $n_c > 1$, center to center, S_c (in) S_c (in) = _____
If $D_{perf} \geq 1.0$ in, $S_c = 4$

Step 7) Number of rows (4" vertical spacing between perforations, center to center), n_r n_r = _____

IIIId. Water Quality Outlet, V-Notch Weir⁶

Step 1) Depth of water quality volume above permanent pool, Z_{WQ} (ft) Z_{WQ} (ft) = _____

Step 2) Average head of water quality pool volume over invert of v-notch, HWQ (ft)
 $H_{WQ} = 0.5 * Z_{WQ}$ H_{WQ} (ft) = _____

Step 3) Average water quality pool outflow rate, Q_{WQ} (cfs)
 $Q_{WQ} = (WQv * 43,560)/(40 * 3,600)$ Q_{WQ} (cfs) = _____

Step 4) V-notch weir coefficient, C_v C_v = _____

Step 5) V-notch weir angle, θ (deg)
 $\theta = 2 * (180/\pi) * \arctan(Q_{WQ}/(C_v * H_{WQ}^{5/2}))$
V-notch angle should be at least 20 degrees. Set to 20 degrees if calculated angle is smaller. θ (deg) = _____

Step 6) V-notch weir top width, W_v (ft)
 $W_v = 2 * Z_{WQ} * \text{TAN}(\theta/2)$ W_v (ft) = _____

Step 7) To calculate v-notch angle for EWDB with an irregular stage-volume relationship, use the V-notch Weir Worksheet

IV. Trash Racks

Step 1) Total outlet area, A_{ot} (in²) A_{ot} (in²) = _____

Step 2) Required trash rack open area, A_t (in²)
 $A_t = A_{ot} * 77 * e^{(-0.124 * D)}$ for single orifice outlet
 $A_t = (A_{ot}/2) * 77 * e^{(-0.124 * D)}$ for orifice plate or perforated riser outlet
 $A_t = 4 * A_{ot}$ for v-notch weir outlet A_t (in²) = _____

V. Forebay

Step 1) Volume should equal at least 10% of WQv Min Vol_{FB} (ac-ft) = _____

Step 2) Forebay depth, Z_{FB} (ft) Z_{FB} (ft) = _____

Step 3) Minimum forebay surface area, A_{FB} (ac) Min A_{FB} (ac) = _____

Step 4) Paved/hard bottom and sides? _____

VI. Littoral Bench

Step 1) Littoral bench should be 25% - 50% of the permanent pool surface area
Min A_{LB} (ac) = _____
Max A_{LB} (ac) = _____

Step 2) Approximate minimum and maximum bench widths, assuming circular permanent pool
Min W_{LB} (ft) = _____
Max W_{LB} (ft) = _____

Step 3) Design bench width around perimeter of EWDB, W_{LB} (ft)
 W_{LB} (ft) = _____

Step 4) Bench depth below permanent pool surface, Z_{LB} (ft)
 Z_{LB} (ft) = _____

VII. Basin side slopes

Basin side slopes should be at least 4:1 (H:V) Side Slope (H:V) = _____

VIII. Dam Embankment side slopes

Dam Embankment side slopes should be at least 3:1 (H:V) Dam Embankment (H:V) = _____

IX. Vegetation

Check the method of vegetation planted in the EWDB or describe "other"

___ Native Grass
___ Irrigated Turf Grass
___ Native Aquatic Species
___ Other: _____

X. Inlet Protection

Indicate method of inlet protection/energy dissipation at EWDB inlet _____

Variable Dictionary

<u>Variable</u>	<u>Units</u>	<u>Definition</u>
A _I	ac	Impervious tributary area
A _{FB}	ac	Forebay surface area
A _{LB}	ac	Littoral bench area
A _o	in ²	Recommended maximum outlet area per row of perforations, for perforated riser or weir plate
A _{ot}	in ²	Total open area of outlet structure
A _P	ac	Pervious tributary area
A _{PP}	ac	Permanent pool surface area
A _t	in ²	Total required trash rack open area
A _T	ac	Tributary area to EWDB
C	none	Rational runoff coefficient
C _o	none	Orifice discharge coefficient
C _v	none	V-Notch weir discharge coefficient
D _o	in	Water quality outlet orifice diameter
D ₁	in	Circular perforation diameter per row, assuming a single column, for perforated riser or weir plate
D _{perf}	in	Design circular perforation diameter for perforated riser or weir plate
H _{WQ}	ft	Average head of WQv over invert of water quality outlet
I	none	Percent impervious area of tributary area to EWDB divided by 100
n _c	none	Number of columns of perforations for perforated riser or weir plate
n _r	none	Number of rows of perforations for perforated riser or weir plate
θ	deg	V-Notch weir angle
Q _{WQ}	cfs	Average WQv outflow rate
R ₁₄	in	Average 14-day wet season rainfall
S _c	in	Horizontal perforation column spacing for perforated riser or weir plate
S _d	in	Mean storm depth
V _{B/R}	none	Ratio of basin volume to runoff volume
V _P	ac-ft	Design permanent pool volume, accounts for 20% of basin filling with sediment
V _{P1}	ac-ft	Permanent pool volume as calculated by method 1
V _{P2}	ac-ft	Permanent pool volume as calculated by method 2
Vol _{FB}	ac-ft	Pre-sedimentation forebay volume
W _{LB}	ft	Littoral bench width
W _v	ft	V-notch weir top width
WQV	ac-ft	Water quality volume
Z _{FB}	ft	Forebay depth
Z _{LB}	ft	Littoral bench depth below permanent pool surface
Z _P	ft	Average permanent pool depth
Z _{WQ}	ft	Depth of WQv above invert of outlet

Part IIIb, Step 5) Water quality outlet orifice diameter derivation from Orifice Equation

$$Q_{WQ} = C_o * A * (2 * g * H)^{0.5} \quad (\text{Orifice Equation})$$

$$Q_{WQ} = C_o * (\pi * D_o^2 / 4) * (2 * g * H)^{0.5} \quad (D_o = \text{orifice diameter in feet})$$

$$D_o = \{4 * Q_{WQ} / [C_o * \pi * (2 * g * H)^{0.5}]\}^{0.5} \quad (\text{Solve for } D_o, \text{ in feet})$$

$$D_o = 12 * 2 * \{Q_{WQ} / [C_o * \pi * (2 * g * H)^{0.5}]\}^{0.5} \quad (\text{Simplify and convert } D_o \text{ to inches})$$

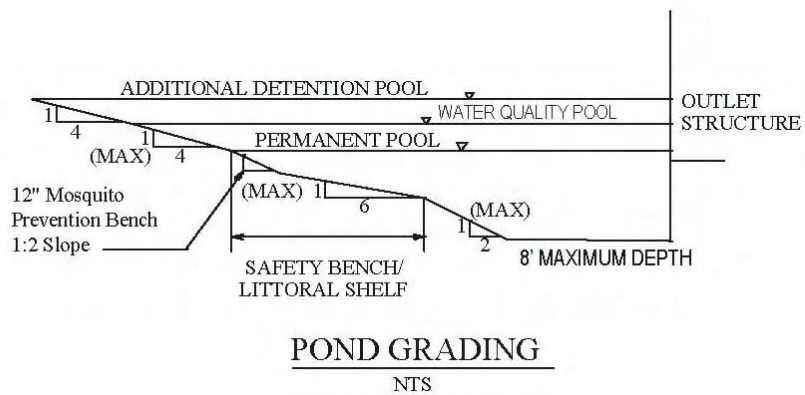
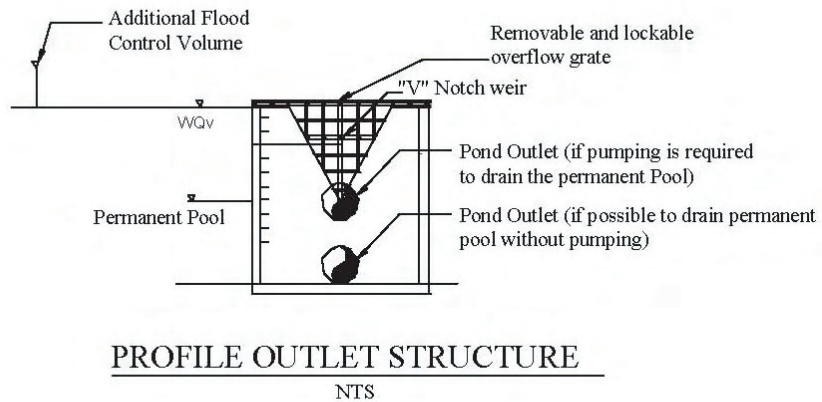
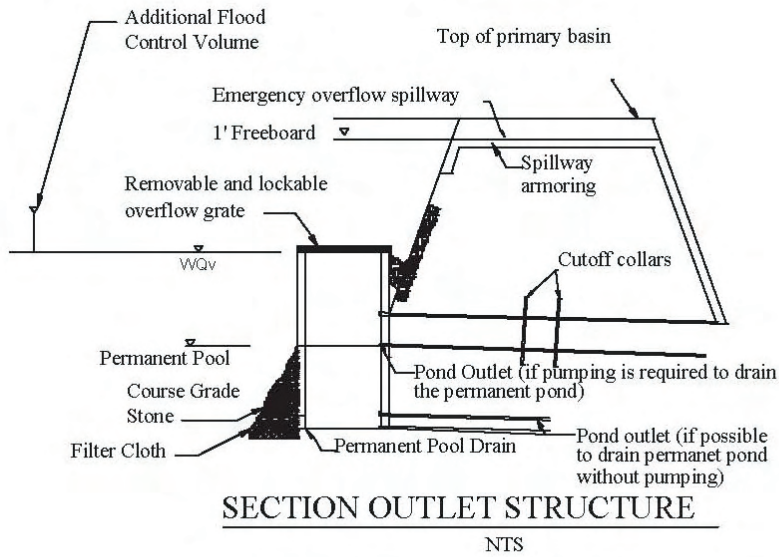

Figure 8.17 - "V" Notch Weir Outlet Structure (2)

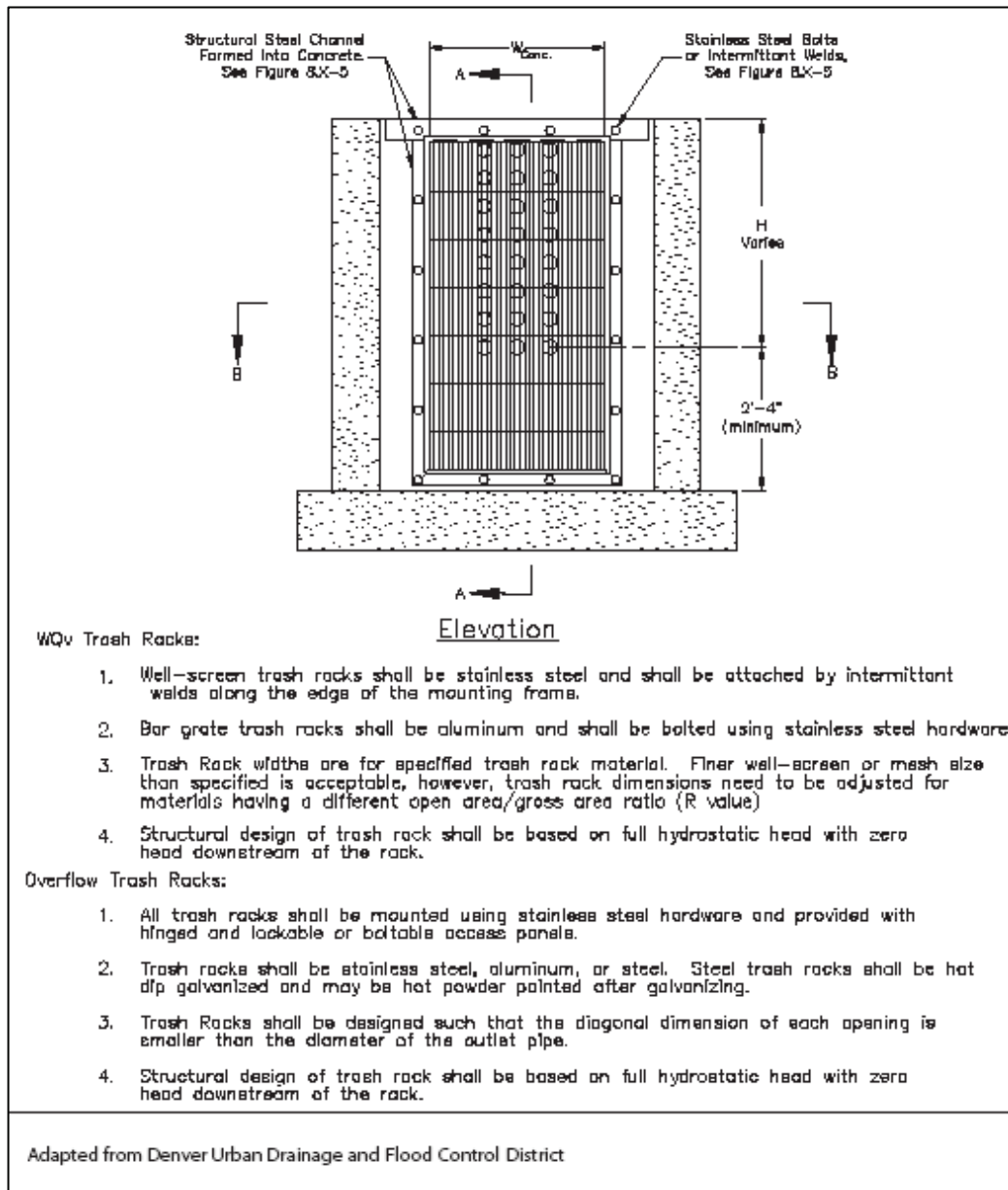

Figure 8.18 - WQv Outlet Trash Rack Design (2)

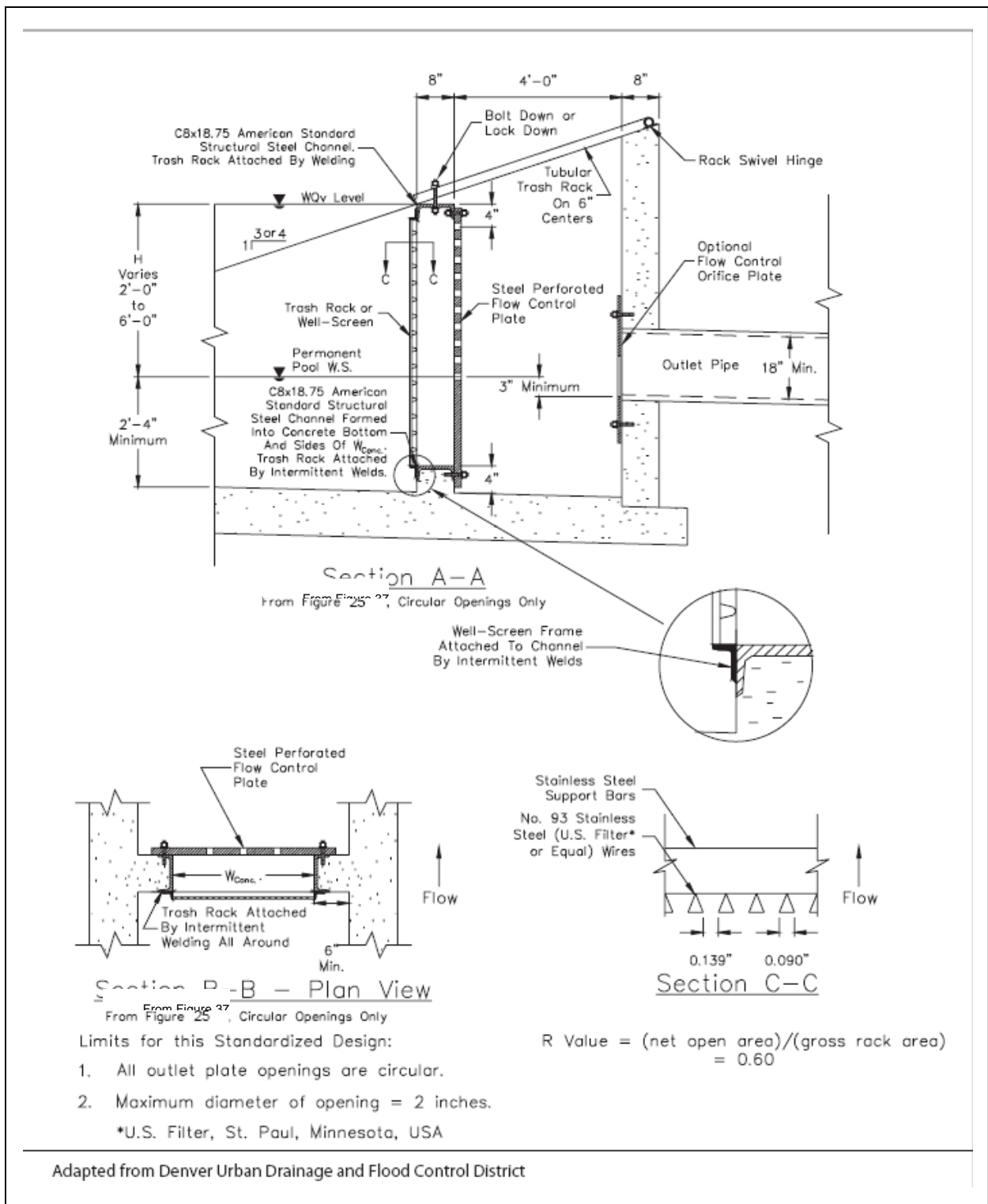

Figure 8.19 - WQv Outlet Trash Rack Design (2)

8.11 NATIVE VEGETATION SWALE

Targeted Constituents	
Sediment	●
Nutrients	◐
Trash	○
Metals	◐
Bacteria	◐
Oil and Grease	○
Organics	◐

Legend (Removal Effectiveness)		
High	Medium	Low
●	◐	○

8.11.1 Description

Native grass swales are broad, shallow, natural, or constructed channels with a dense native grass stand covering the side slopes and channel bottom. They slowly convey stormwater runoff and, in the process promote infiltration, reduce flow velocities, and pretreat stormwater. Native grass swales can have either parabolic or trapezoidal cross sections and are intended to be used as a substitute for traditional pipe systems to convey roadway, parking lot and other site drainage.

8.11.2 General Application

Native grass swales can serve as part of a stormwater drainage system and can replace curb and gutter storm sewer systems. **Figure 8.20** illustrates a typical Native Grass Swale. Native grass swales promote infiltration and also help settle many particulate contaminants by slowing flow velocities. Native Grass Swales are intended to treat areas of approximately 5 acres or less to maintain their effectiveness. Larger drainage areas produce too much water for the swale to be effective. Do not use swales as a BMP component to convey deep concentrated flow; swales are only effective conveying shallow concentrated flow. Take care to identify the proper location for a native grass swale. Minimizing disturbance to the area (for example, avoiding application of pesticides and herbicides) maintains the channel's ability to remove contaminants. Select grass species tolerant of frequent inundation from **Appendix A**.

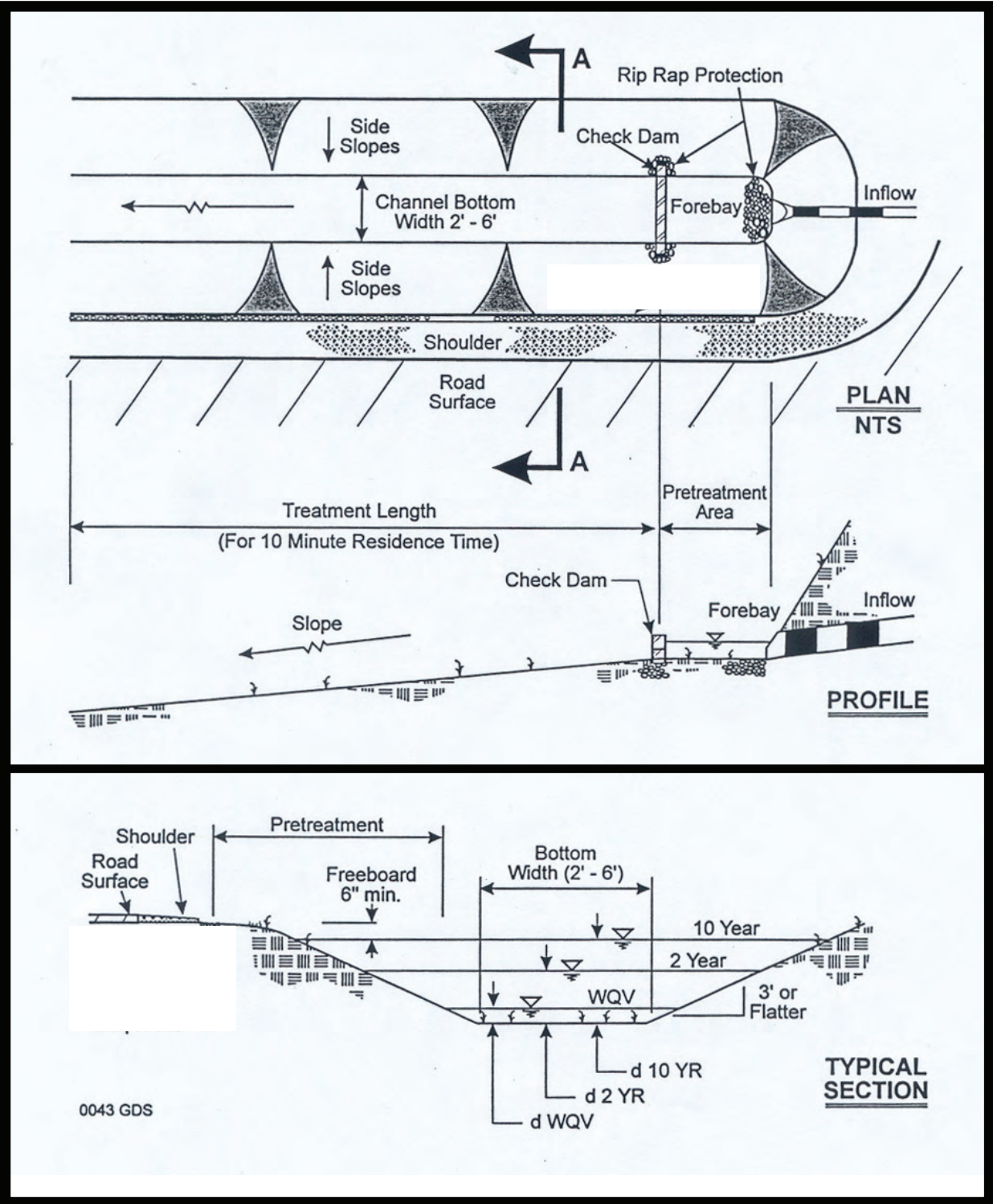

Source: CWP 1996

FIGURE 8.20 – Native Vegetation Swale Plan and Profile Example
(for informational purposes only)

8.11.3 Advantages

- Constructed less expensively and maintained more easily than underground pipes
- Improve water quality by infiltration, sedimentation and biological uptake
- Reduce total volume of runoff to surrounding streams and rivers
- Minimize erosion by slowing the conveyance of water.

8.11.4 Disadvantages

- May require irrigation to establish proper vegetative cover for controlling erosion and reducing pollution in the channel
- May require the use of erosion control or turf reinforcement mats on slopes as prior to full establishment of the vegetation.
- May not be feasible to implement after development has occurred
- Area requirements can be excessive for highly developed sites.
- Require relatively large areas, proper sloping, and connection with other conveyance components
- Not designed to be the fastest conveyance method and, therefore, require exact placement and design to minimize risk of flooding.

8.11.5 Design Considerations

The design approach for sizing native grass swales is based on conveying the water quality flow at a shallow depth (<4"). This methodology incorporates a flowrate-based sizing criteria for the water quality, 1%, and 10% frequency storm (see **Figure 8.20**). Provide bypass for high flows if the swale cannot be stable during the 10% or greater storm.

The following design specifications are summarized in **Table 8.8**.

8.11.5.1 Shape and Slope

- The swales should generally be trapezoidal in shape, although a parabolic shape is also acceptable (provided the width is equal to or greater than the design bottom width for a trapezoidal cross section). The criteria presented in this section assume a trapezoidal cross section.
- For the trapezoidal cross section, size of the bottom width between two and eight feet. The two feet minimum allows for construction considerations and ensures a minimum filtering surface for water quality treatment. The eight feet maximum reduces the likelihood of flow channelization within a portion of the swale.
- The side slopes of the channel should be no steeper than 3:1 for maintenance and safety considerations. Flatter slopes are encouraged where adequate space is available to aid in providing pretreatment for lateral flows.
- The longitudinal slope of the swale should be moderately flat to provide the slowest flow rate possible. When natural topography necessitates, steeper slopes may be acceptable if check dams (vertical drops of 6 to 12 inches) are used (see **Figure 8.21**). These structures will require additional energy dissipating measures and should be placed no closer than 50 to 100 foot interval.
- The minimum length of a native grass swale should be 100 feet to provide adequate water quality treatment.

TABLE 8.8
Design Summary for Native Vegetation Swales

Parameter	Swale Design Criteria
Energy Dissipation	Required if piped inflow
Preferred Shape	Trapezoidal or Parabolic
Bottom Width	2 feet minimum; 8 feet maximum.
Side Slopes	3:1 or flatter preferred
Longitudinal Slope	1.0% to 2.5% without check dams
Underlying soil bed	Undisturbed soils equal to the Swale width No underdrain system
Drainage Area	5 acres or less
Minimum Length	Length based on 5-minute residence time, or 100 feet; which ever is greater.
Depth and Capacity	Convey the WQf with a maximum depth of 4 inches and a maximum velocity of 1fps Safely convey the 50% event with non-erosive velocity (< 4 fps). Consult local design criteria for flows greater than the 50% storm event.

8.11.5.2 Design Size and Soils

- Design swales to provide a shallow flow depth for the water quality storm (a maximum of 4 inches for the water quality flow is recommended), safely convey the 50% storm with design velocities appropriate for the soil and cover types, and provide adequate capacity for the 10% and 1% storm with a minimum of 1 foot of freeboard if applicable.
- Provide minimum freeboard above 1% storm water surface profile (1.0 foot minimum or as required by local ordinance)
- Ensure the soil bed below the swale consists of undisturbed or lightly compacted soils. This area may be periodically inundated and remain wet for long periods of time.
- Do not construct native grass swales in gravelly and coarse sandy soils that cannot easily support dense vegetation.
- In areas with steep slopes, employ native grass swales in locations where they can be parallel to the contours.
- Size swales to convey the 10% and 1% storm volumes and design channel slopes to prevent erosion during the 50% storm events.
- Use outlet protection at any discharge point from native grass swales to prevent scour at the outlet.

-
- Identify the swale bottom, width, depth, length, and slope necessary to convey the water quality flow rate with a shallow ponding depth (approximate maximum of 4 inches).
 - Compute the 50%, 10%, and 1% frequency storm event peak discharges.
 - Check the 10% and 1% velocity for erosive potential (adjust swale geometry, if necessary reevaluate WQv design parameters).
 - Provide pretreatment to protect the filtering and infiltration capacity of the swale bed. Pretreatment can occur in a sediment forebay behind a check dam with a pipe inlet.
 - Use check dams in native grass swales to achieve flatter sections with slower velocities. V-notched weirs in the check dams can be utilized to direct flow and volumes.
 - Design native grass swales with trapezoidal or parabolic cross sections, and with side slopes no greater than 3:1 (horizontal:vertical) and bottom widths ranging from 2 to 8 feet.
 - Check permissible velocities of selected vegetation to ensure the 50% frequency storm is non-erosive.

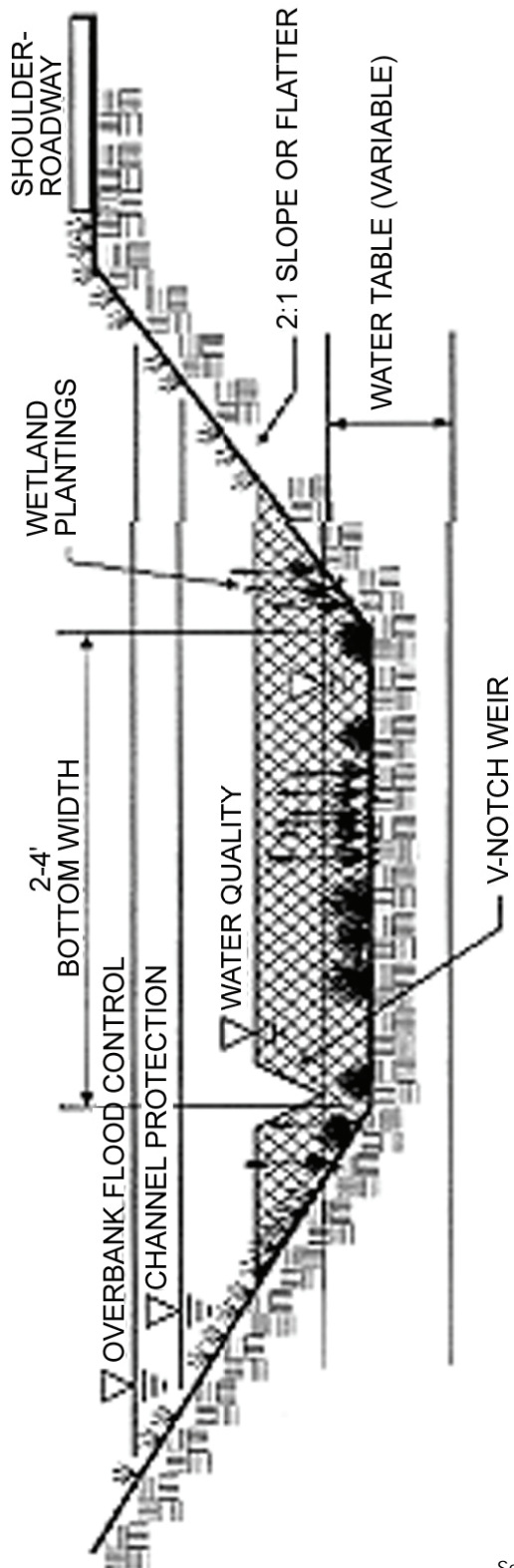

FIGURE 8.21 – Typical Native Vegetation Swale Ditch Check
 (for informational purposes only)

Source: Center for Watershed Protection . 2001

8.11.5.3 Vegetative Cover

- Native grass species selection will depend upon the duration of water inundation, soil type, the amount of sunlight and aesthetic considerations.
- Specify native grass species resistant to periodic inundation and periodic drought.
- Use native plant plugs for initial installation.
- Appropriate soil stabilization methods, such as mulch, blankets or mats should be used before the establishment of vegetation. Seeding, sodding, and other items related to establishing vegetation should be in accordance with accepted erosion-control and planning practices.

8.11.6 Maintenance and Inspections

Source: Metropolitan Council Environmental Services. 2001 *Minnesota Urban Small Sites BMP Manual*, St. Paul, MN.

The following is a partial list of actions to upkeep wetland swales:

- Inspect swale several times the first few months to ensure plant species are establishing well. If not, reseed or plant an alternative species. Also, inspect the channel for erosion after every rainfall event and repair as necessary.
- If a forebay is used, inspect and remove excessive sediment, trash, and debris and dispose of in an appropriate location.
- Control vegetation by mowing or grubbing techniques (not by chemicals).
- If heavy sediment loading occurs, clean the channel to remove excess particulates.

8.11.7 Design Example

8.11.7.1 Design Calculations

Step 1 - Find peak flowrate (Q) for tributary area to swale for water quality rainfall event using Rational Method.

$$Q_{WQ} = K \cdot C \cdot i \cdot A$$

Where:

Q = Peak flowrate of runoff (cfs)

C = Runoff Coefficient = $0.3 + 0.6 \times I$, where I is percent impervious divided by 100

I = Rainfall intensity for water quality rainfall event at the duration equal to the calculated time of concentration (inches/hr) from Section 6.

A = Tributary drainage area (acres)

K = Dimensionless coefficient to account for antecedent precipitation

1.0 for the Water Quality Storm

Step 2 - Solve Manning's equation for a specified variable. For this example, we will calculate flowrate at the maximum allowable depth to verify the swale can carry the proposed peak flowrate. This step is most easily accomplished using a spreadsheet or solver program.

Step 3 - Solve $V = Q/A$ for velocity using calculated variable and Q calculated in Step 1. If V is greater than 1 ft/s, the width of channel, longitudinal slope of channel, or Manning's n value may need to be adjusted to obtain a velocity less than 1 fps, and therefore appropriate for shallow flow.

Step 4 – Solve for the minimum swale length: $L = V \times 5 \text{ min} \times 60 \text{ sec/min}$. Minimu 100 feet.

Step 5 - Find peak flowrate (Q) for tributary area to swale for the 50% rainfall event using Rational Method.

Step 6 - Solve $V = Q/A$ for velocity using calculated area and Q calculated in Step 4. If V is greater than 4 ft/s, the shape of channel or longitudinal slope of channel may need to be adjusted to obtain a non-erosive velocity less than 4 fps.

Note that an agency may require that a swale also be designed for conveyance of a defined design storm (e.g. 10% or 1% storm event). Additional calculations may be necessary to size the swale for other larger events.

8.11.7.2 Design Example

A 1.73-acre commercial site is being developed on a previously undeveloped site and proposes using a native vegetation swale to carry stormwater runoff and treat the water quality event. The swale will be 7-foot wide with 5:1 side slopes and a longitudinal slope of 1.0%. The site's runoff coefficient, C, is 0.67 with an assumed 10 minute time of concentration. Verify the swale design with the BMP manual guidelines.

Step 1 - Calculate the water quality rainfall event Q using the Rational Method. Methodology can be found in Section 6 of this manual.

$$Q = (1.0) \times (0.67) \times (1.68 \text{ in/hr}) \times (1.73 \text{ acre}) = 1.95 \text{ cfs}$$

Step 2 - Using a solver program, peak flow rate for a 4-inch flow depth in the swale was calculated using Manning's equation.

Trapezoidal (5:1) Swale Example

n value	Depth (D) feet	Width (W) feet	Area (A) (ft ²)	Wetted Perimeter (ft)	Hydraulic Radius (R _n) (ft)	Longitudinal Slope (ft/ft)	Iterated Q (CFS)
0.09	0.17	7.00	2.86	10.37	0.28	0.01	1.99

The proposed swale can carry 1.99 cfs at a 4-inch depth; therefore the swale will carry the Water Quality peak flow of 1.95 cfs below the maximum 4-inch depth.

Step 3 - Calculate Velocity.

$$V = (1.99 \text{ cfs}) / (2.86 \text{ ft}^2) = 0.70 \text{ ft/s. This is less than 1 ft/s, and therefore meets recommendations for the Water Quality Storm.}$$

Step 4 – Calculate Length

$$L = 0.70 \text{ ft/s} \times 5 \text{ min} \times 60 \text{ sec/min} = 210 \text{ ft}$$

Step 5 - Calculate the 50% rainfall event Q using the Rational Method. Methodology can be found in APWA 5602.

$$Q = (1.0) \times (0.67) \times (4.30 \text{ in/hr}) \times (1.76 \text{ acre}) = 5.10 \text{ cfs}$$

Step 6 - Using a solver program, 50% storm event flow depth and area in the swale were calculated using Manning's equation.

Trapezoidal (5:1) Swale Example

n value	Depth (D) feet	Width (W) feet	Iterated Area (A) ft ²	Wetted Perimeter (ft)	Hydraulic Radius(H _R) (ft)	Long Slope (ft/ft)	Q (CFS)
0.09	0.58	7.00	5.45	12.68	0.43	0.01	5.10

$V = (5.10 \text{ cfs}) / (5.45 \text{ ft}^2) = 0.94 \text{ ft/s}$. This is less than 4 ft/s, and therefore meets recommendations for non-erosive velocities.

8.12 EXTENDED DRY DETENTION BASIN



Source: California Stormwater Quality Association, 2003.

Targeted Constituents

Sediment	●
Nutrients	○
Trash	●
Metals	●
Bacteria	●
Oil and Grease	○
Organics	●

Legend (Removal Effectiveness)

High	Medium	Low
●	●	○

8.12.1 Description

Extended dry detention basins (EDDBs) are designed to detain the stormwater water quality volume (WQv) for 40 hours to allow particles and associated pollutants to settle (Urban Drainage and Flood Control District, Denver, Colorado, 2005). Unlike extended wet detention basins, these facilities do not maintain a permanent pool between storm events (California Stormwater Quality Association, 2003). However, EDDBs may develop wetland vegetation and sometimes shallow pools in the bottom portions of the facilities (e.g., sediment forebays) that can enhance the basin's soluble pollutant removal efficiency through maintenance removal and biological uptake (Urban Drainage and Flood Control District, Denver, Colorado, 2005).

8.12.2 General Application

EDDBs can be used to improve stormwater runoff quality and reduce peak stormwater runoff rates and peak stages. If these basins are constructed early in the development cycle, they can also be used to trap sediment from construction activities within the tributary drainage area. The accumulated sediment, however, will need to be removed after upstream land disturbances cease and before the basin is placed into final long-term use.

EDDBs can be used to improve the quality of urban runoff coming from roads, parking lots, residential neighborhoods, commercial areas, and industrial sites, and are generally used for site or regional treatment (Urban Drainage and Flood Control District, Denver, Colorado, 2005). They can be used as an onsite BMP that works well with other BMPs, such as upstream onsite source controls and downstream infiltration/filtration basins or wetland channels. If desired, additional volume can be provided in an EDDB for flood control benefits (Urban Drainage and Flood Control District, Denver, Colorado, 2005).

8.12.3 Advantages

- Because of the simplicity of design, extended detention basins are relatively easy and inexpensive to construct and operate (California Stormwater Quality Association, 2003).
- EDDBs can provide substantial capture of sediment and the pollutants adsorbed onto the surfaces of the particles (California Stormwater Quality Association, 2003).
- Widespread application of EDDBs with sufficient capture volume can provide significant control of channel erosion and enlargement caused by changes to flow frequency relationships resulting from the increase of impervious cover in a watershed (California Stormwater Quality Association, 2003).

-
- EDDBs can be designed to provide other benefits, such as recreation and open space opportunities, in addition to reducing peak runoff rates and improving water quality (Urban Drainage and Flood Control District, Denver, Colorado, 2005) (Metropolitan Nashville – Davidson County, 2000).

8.12.4 Disadvantages

- EDDBs have only moderate pollutant removal when compared to some other structural stormwater practices, and they are relatively ineffective at removing soluble pollutants (California Stormwater Quality Association, 2003).
- Dry ponds can potentially detract from the value of a home because of the adverse aesthetics of dry, bare areas and inlet and outlet structures; however, wet ponds can increase property values (California Stormwater Quality Association, 2003).

8.12.5 Design Requirements and Considerations

The following guidelines shall be considered when designing EDDBs (Figure 8.22):

- EDDBs shall be designed to limit environmental impacts downstream when maintaining the facility (Metropolitan Nashville – Davidson County, 2000). EDDBs shall be placed outside of stream corridors and stream buffer zones.
- Capture volume shall be sized to treat the WQv and discharge over a period of 40 hours. Refer to Section 6 of this manual.
- When computer software is used to size the water quality outlet, a drawdown of 40 hours is reached when at least 90 percent of the WQv has exited the basin within 40 hours.
- A sediment forebay shall be incorporated into the EDDB design to trap sediment and trash at all basin inlets, where the sediment and trash can be more easily removed than from the permanent pool (Kansas City Metropolitan Chapter of the American Public Works Administration, 2006). The forebay shall be at least 10 percent of the WQv and shall be 4 to 6 feet deep. The forebay can also facilitate maintenance by concentrating sediment in an accessible location. The forebay consists of a separate cell, formed by an acceptable barrier such as a vegetated earthen weir. To make sediment removal easier, the bottom and side slopes of the forebay may be lined with concrete (Urban Drainage and Flood Control District, Denver, Colorado, 2005) (Camp Dresser & McKee, Inc., 2005). This area should be designed to minimize aesthetic problems associated with sediment and debris accumulation and saturated soils in this portion of the basin (Camp Dresser & McKee, Inc., 2005). Other pretreatment devices and processes may also be applicable.
- Additional design inlet considerations should include energy dissipaters to reduce inflow velocity, scour potential, and the turbulence and mixing currents that disturb sedimentation (Urban Drainage and Flood Control District, Denver, Colorado, 2005) (Camp Dresser & McKee, Inc., 2005).
- Locate basin outlet as far away from basin inlet as possible to prevent water from short-circuiting the facility (Metropolitan Nashville – Davidson County, 2000).
- Basin depths shall range from 2 feet to 5 feet for the WQv (California Stormwater Quality Association, 2003). A shallow pond with large surface area performs better than a deep pond with the same volume (Metropolitan Nashville – Davidson County, 2000).
- Side slopes shall be at least 4:1 (H:V) if basin is designed for the WQv only (Metropolitan Nashville – Davidson County, 2000). A side slope of 3:1 is acceptable for basins designed to capture flood flows.
- Vegetate side slopes and bottom using native vegetation to the maximum extent practical (Metropolitan Nashville – Davidson County, 2000).
- Provide embankment freeboard of at least 1 foot when detaining the WQv only. If flood storage volume is also included in the design, refer to Section 5600 for embankment design criteria.

-
- Do not locate EDDBs on fill sites or on or near steep slopes if it is expected that much of the water will exit through the bottom of the facility, unless the bottom of the facility is modified to prevent excessive infiltration (Metropolitan Nashville – Davidson County, 2000).
 - Energy dissipation shall be included in the inlet design to reduce resuspension of accumulated sediment (California Stormwater Quality Association, 2003).
 - Erosion protection shall be placed at the facility's outfall. Energy dissipation may be required to reduce flow velocities from the primary spillway to nonerosive values (California Stormwater Quality Association, 2003).
 - A maintenance ramp and perimeter access shall be included in the design to facilitate access to the basin for maintenance activities (California Stormwater Quality Association, 2003).
 - When desirable and feasible, EDDBs shall be incorporated within a larger flood control basin or as a part of a full-spectrum detention facility. See APWA 5600 for design specifications if flood control is to be incorporated into the design of the EDDB. Also, whenever possible, designers should try to accommodate within the basin other urban uses such as passive recreation and wildlife habitat (Urban Drainage and Flood Control District, Denver, Colorado, 2005).
 - EDDBs that do not provide flood storage for the 1 percent storm shall be designed so that runoff flows from the 1 percent event safely pass through the facility. At a minimum, all facility embankments shall be protected from failure during the 1 percent event. An emergency spillway, which conveys large flood flows safely past earth embankments, must be provided for each dam unless the principal spillway is large enough to pass the peak flow expected from the 1 percent design storm without overtopping the dam (Natural Resources Conservation Service – Maryland, 2000).
 - The EDDB bottom should be 1 to 2 feet above the wet season groundwater table, as groundwater may surface within the basin or contribute baseflow to the basin (Urban Drainage and Flood Control District, Denver, Colorado, 2005). This also allows for some infiltration.
 - Outflow structures shall be protected by well screen, trash racks, grates, stone filters, or other approved devices to ensure that the outlet works will remain functional (Kansas City Metropolitan Chapter of the American Public Works Administration, 2006). No single outlet orifice shall be less than 4 inches in diameter (smaller orifices are more susceptible to clogging). If the calculated orifice diameter necessary to achieve a 40-hour drawdown is less than 4 inches, a perforated riser, orifice plate, or v-notch weir shall be used instead of a single orifice outlet. Keep perforations larger than 1 inch when using orifice plates or perforated risers. Smaller orifice sizes may be used if the weir plate is placed in a riser manhole in a sump-like condition.
 - Public safety shall be considered in EDDB design. Fences and landscaping can be used to impede access to the facility. The facility shall be contoured so as to eliminate any dropoffs or other hazards. The primary spillway opening must not permit access by small children. Outfall pipes above 48 inches in diameter shall be fenced (California Stormwater Quality Association, 2003).
 - Facilities that receive stormwater from contributing areas that have potential for oil and grease contamination must include a baffle, skimmer, and grease trap to prevent these substances from being discharged from the facility (Metropolitan Nashville – Davidson County, 2000).

8.12.6 Maintenance and Inspections

Routine maintenance activity is often thought to consist mostly of sediment and trash and debris removal; however, these activities often constitute only a small fraction of the maintenance hours. Often, the largest EDDB maintenance activity in terms of labor hours is vegetation management, such as routine mowing (California Stormwater Quality Association, 2003).

Consequently, maintenance costs should be estimated based primarily on the mowing frequency and the time required. Mowing should be done at least annually to avoid establishment of woody vegetation, but may need to be performed much more frequently if aesthetics are an important consideration (California Stormwater Quality Association, 2003).

Typical activities and frequencies include:

- Schedule semiannual inspection for the beginning and end of the wet season and after each extreme storm event for standing water, slope stability, sediment accumulation, trash and debris, and presence of burrows (California Stormwater Quality Association, 2003) (Metropolitan Nashville – Davidson County, 2000). The banks and bottom of the EDDB shall be checked and areas of erosion repaired. Remove nuisance wetland species and take appropriate measures to control mosquitoes. Remove sediments if they are within 18 inches of an orifice plate (Metropolitan Nashville – Davidson County, 2000).
- Remove accumulated trash and debris in the basin and around the outlet structure during the semiannual inspections. The frequency of this activity may be altered to meet specific site conditions (California Stormwater Quality Association, 2003).
- Trim vegetation at the beginning and end of the wet season and inspect monthly to prevent establishment of woody vegetation and for aesthetic and vector reasons (California Stormwater Quality Association, 2003).
- Check outlet after each storm event greater than 0.5 inches for clogging and remove any debris.
- Grassy areas shall be mowed annually, unless the unchecked growth of native grass banks interferes with multiuse objective. Repairs shall be made to signage, walkways, picnic tables, or any other public recreation equipment as needed. If both the operational and aesthetic characteristics of a dry pond are not maintained, then it will be viewed as an eyesore and negative environmental impact even if it is functioning properly (Metropolitan Nashville – Davidson County, 2000).
- Remove sediment when accumulation reaches 6 inches, or if resuspension is observed or probable. Sediment may be permitted to accumulate deeper than 6 inches if there is a permanent marker indicating the depth where sediment needs to be removed and that mark has not been met (Metropolitan Nashville – Davidson County, 2000).

8.12.6.1 Sediment Removal

Some sediment may contain contaminants of which the Kansas Department of Health and Environment (KDHE) or Missouri Department of Natural Resources (MDNR) requires special disposal procedures. If there is any uncertainty about what the sediment contains or it is known to contain contaminants, then KDHE or MDNR should be consulted and their disposal recommendations followed. Sampling and testing shall be performed on sediments accumulated in facilities serving industrial, manufacturing or heavy commercial sites, fueling centers or automotive maintenance areas, large parking areas, or other areas where pollutants (other than “clean” soil) are suspected to accumulate and be conveyed via stormwater runoff (Metropolitan Nashville – Davidson County, 2000).

Some sediment collected may be innocuous (free of pollutants other than “clean” soil) and can be used as fill material, cover, or land spreading. It is important that this material not be placed in a way that will promote or allow resuspension in stormwater runoff. The sediment shall not be placed within the high water level area of the EDDB, other BMP, creek, waterway, buffer, runoff conveyance device, or other infrastructure. Some demolition or sanitary landfill operators will allow the sediment to be disposed at their facility for use as cover. This generally requires that the sediment be tested to ensure that it is innocuous (Metropolitan Nashville – Davidson County, 2000).

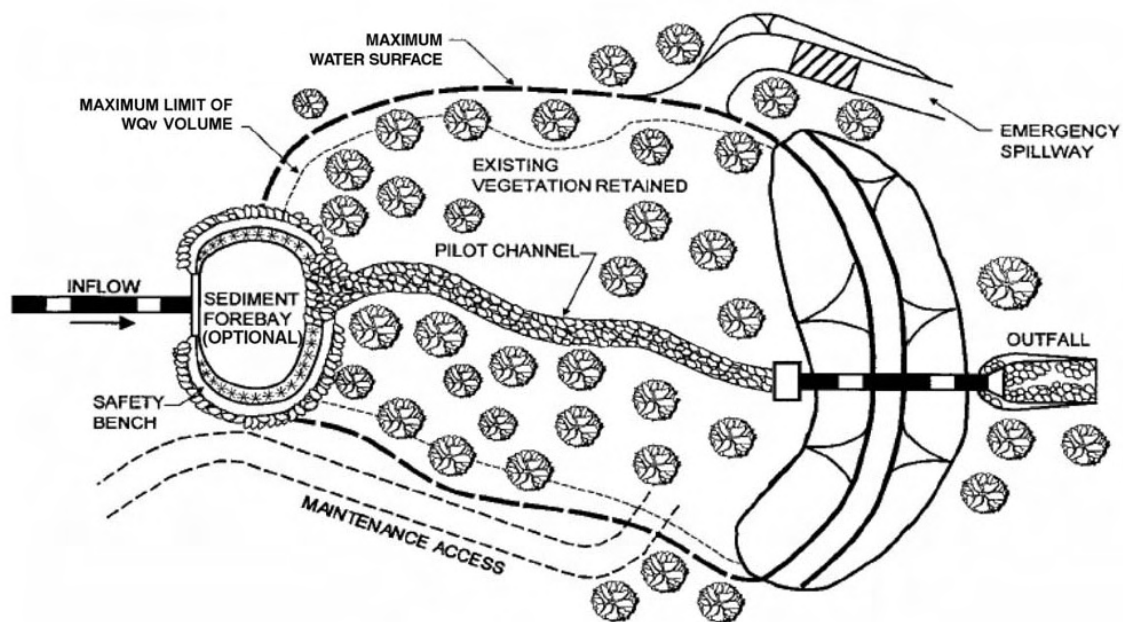

Plan

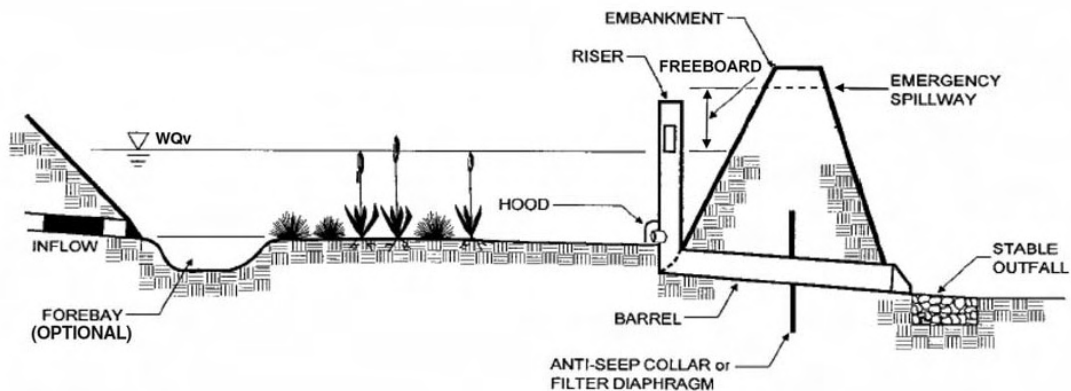

Profile

Figure 8.22 - Schematic of an Extended Dry Detention Basin

(Adapted from Maryland Department of Environment, 2000)

8.12.7 Design Example

The following sections present an example for designing an EDDB. These procedures follow the steps outlined in the Design Procedure Form: Extended Dry Detention Basin (EDDB) Main Worksheet. When using the worksheet in electronic form, manually enter values in green.

8.12.7.1 Example

You are developing a 26-acre lot of previously undeveloped land for mixed use, to include a small shopping center and medium density residential areas. Design an extended dry detention basin to treat the water quality rainfall event for the Kansas City Metropolitan Area of 1.4 inches. Incorporate an outlet structure that will release the WQv over a period of 40 hours.

I. Basin Water Quality Storage Volume

- Step 1 - Enter the tributary area to the EDDB (AT).
- Step 2 - Calculate the WQv using the methodology presented in Section 6 of this manual.
- Step 3 - Add 20 percent to account for silt and sediment deposition in the basin (V_{design}).

IIa. Water Quality Outlet Type

- Step 1 - Select type of water quality outlet: single orifice, v-notch weir, or perforated riser/plate.
- Step 2 - Proceed to Part IIb, IIc, or II d based on water quality outlet type selected in Step 1.

IIb. Water Quality Outlet, Single Orifice (City of Knoxville, 2001)

- Step 1 - Set depth above WQv outlet (Z_{WQ}) based on required WQv and desired facility dimensions (surface area, depth). Facility dimensions should be designed to conform to specific site constraints.
- Step 2 - Calculate the average head of the WQv over the orifice invert (H_{WQ}) as ½ the WQv depth:

$$H_{WQ} = 0.5 * Z_{WQ}$$

- Step 3 - Calculate the average water quality outflow rate (Q_{WQ}) that would result in the entire WQv draining over a period of 40 hours:

$$Q_{WQ} = (WQv * 43,560)/(40 * 3,600)$$

- Step 4 - Set the value of the orifice discharge coefficient (C_o) based on orifice geometry and thickness of riser/weir plate.
- Step 5 - Calculate the required water quality outlet orifice diameter (D_o) from parameters determined in Steps 2, 3, and 4. Orifice diameter should be larger than 0.5 inches to reduce the chance for clogging.

$$D_o = 12 * 2 * (Q_{WQ}/(C_o * \pi * (2 * g * H)^{0.5}))^{0.5}$$

- Step 6 - To size a single water quality outlet orifice for an EDDB with an irregular stage-volume relationship, use the Single Orifice Worksheet. Fill in the first column with cumulative volume values for each depth interval. The Single Orifice Worksheet uses values from Part IIb of the Main Worksheet.

IIc. Water Quality Outlet, Perforated Riser, or Plate

(Urban Drainage and Flood Control District, Denver, Colorado, 2005)

- Step 1 - Set depth above WQv outlet (Z_{WQ}) based on required WQv and desired facility dimensions (surface area, depth). Facility dimensions should be designed to conform to specific site constraints.
- Step 2 - Calculate the recommended maximum outlet area per row of perforations based on the WQv and the depth at the basin outlet:

$$A_o = WQv/(0.013 * Z_{WQ}^2 + 0.22 * Z_{WQ} - 0.10)$$

- Step 3 - Assuming a single column, calculate the diameter of a single circular perforation for each row (D_i) based on the outlet area calculated in Step 2.

-
- Step 4 - Set the number of columns of perforations (n_c). Keep this number as low as possible, optimally 1. If the diameter calculated in Step 3 is greater than 2 inches, make the number of columns greater than 1.
 - Step 5 - Calculate the design circular perforation diameter (D_{perf}) based on the area calculated in Step 2 and the number of columns set in Step 4. Iteratively increase the number of columns until this design diameter is between 1 and 2 inches.
 - Step 6 - Calculate the horizontal perforation column spacing (S_c), center to center, when the number of columns is greater than 1. As long as the perforation diameter calculated in Step 5 is greater than 1, the horizontal perforation column spacing should be 4 inches.
 - Step 7 - Calculate the number of rows of perforations (n_r), center to center, based on a 4-inch vertical spacing and depth at outlet from Step 1.

IId. Water Quality Outlet, V-notch Weir (City of Knoxville, 2001)

Step 1 - Set depth above WQv outlet (Z_{WQ}) based on required WQv and desired facility dimensions (surface area, depth). Facility dimensions should be designed to conform to specific site constraints.

Step 2- Calculate the average head of the WQv (H_{WQ}) over the v-notch invert as $\frac{1}{2}$ the WQv depth:

$$H_{WQ} = 0.5 * Z_{WQ}$$

Step 3- Calculate the average water quality outflow rate (Q_{WQ}) that would result in the entire WQv draining over a period of 40 hours:

$$Q_{WQ} = (WQv * 43,560)/(40 * 3,600)$$

Step 4 - Select the value of the v-notch weir discharge coefficient ($C_v = 2.5$ typical)

Step 5 - Calculate the required v-notch weir angle (θ) from parameters determined in Steps 2, 3, and 4. If the calculated v-notch weir angle is less than 20 degrees, set to 20 degrees.

$$\theta = 2 * (180/\pi) * \arctan(Q_{WQ}/(C_v * H_{WQ}^{5/2}))$$

Step 6 - Calculate the top width of the v-notch weir:

$$W_v = 2 * Z_{WQ} * \tan(\theta/2)$$

Step 7 - To size a v-notch weir for an EDDB with an irregular stage-volume relationship, use the V-Notch Weir Worksheet. Fill in the first column with cumulative volume values for each depth interval. The V-Notch Weir Worksheet uses values from Part IId of the Main Worksheet.

III. Flood Control

If facility is to provide flood control storage in addition to the WQv, design basin to specifications given in the Kansas City Metropolitan Chapter of the American Water Works Association Specifications Section 5608.

IV. Trash Racks (Urban Drainage and Flood Control District, Denver, Colorado, 2005)

Step 1- Calculate the total water quality outlet area (A_{ot}) from IId, IId, or IId, whichever outlet configuration you selected.

Step 2- Calculate the required trash rack open area (A_t) from the total outlet area. **Figures 8.25 and 8.26** show suggested details for trash racks over perforated riser outlets.

$$A_t = A_{ot} * 77 * e^{(-0.124 * D)} \text{ for single orifice outlet}$$

$$A_t = (A_{ot}/2) * 77 * e^{(-0.124 * D)} \text{ for orifice plate or perforated riser outlet}$$

$$A_t = 4 * A_{ot} \text{ for v-notch weir outlet}$$

V. Basin Shape (Urban Drainage and Flood Control District, Denver, Colorado, 2005) (City of Knoxville, 2001)

- Step 1- The flow path through the facility shall be made as long as possible to increase stormwater runoff residence time in the basin (Urban Drainage and Flood Control District, Denver, Colorado, 2005).
- Step 2- A pilot channel can be constructed through the main part of the facility to convey low flows from the forebay to the bottom stage. Make it at least 4 inches deep if concrete lined sides and 8 inches if buried riprap sides are used. At a minimum, provide conveyance capacity equal to twice the release capacity at the upstream forebay outlet (Urban Drainage and Flood Control District, Denver, Colorado, 2005).
- Step 3- The top stage is the basin bottom adjacent to the pilot channel on either side. It shall be at least 1 foot deep (D_{ts}) with its bottom sloped 1 percent to 2 percent toward the pilot channel (S_{ts}) (Urban Drainage and Flood Control District, Denver, Colorado, 2005).
- Step 4- The bottom stage is the deep portion of the EDDB around the outlet structure. This part of the basin shall be 1.25 to 3.0 feet deeper than the top stage. The bottom stage shall store 10 percent to 25 percent of the WQv below the top stage (V_{bs}).

VI. Forebay (Optional) (Urban Drainage and Flood Control District, Denver, Colorado, 2005)

- Step 1- Forebay volume (Vol_{FB}) should equal at least 10 percent of the WQv calculated in Part I, Step 2.
- Step 2- Set the desired peak forebay depth (Z_{FB}) in the water quality rainfall event. This depth is commonly maintained with a secondary berm in the EDDB.
- Step 3- Calculate the required forebay surface area (A_{FB}) based on the volume calculated in Step 1 and peak depth calculated in Step 2.
- Step 4- Ensure that the sides and bottom of the forebay are paved or hardened to ease removal of silt and sedimentation from the forebay.

VII. Basin Side Slopes (Urban Drainage and Flood Control District, Denver, Colorado, 2005)

Basin side slopes shall be at least 4:1 (H:V) if basin is designed for the water quality control volume only. A side slope of 3:1 is acceptable for basins designed to capture flood flows.

VIII. Dam Embankment Side Slopes (Urban Drainage and Flood Control District, Denver, Colorado, 2005) (Kansas State Board of Agriculture, Division of Water Resources, 1986)

Dam embankment side slopes should be at least 3:1 (H:V) for public safety. Embankment soils should be compacted to at least 95 percent of their maximum density according to ASTM D 698-70 (Modified Proctor). Embankment slopes should be planted with turf-forming grasses. Earth dam designs shall comply with all federal, state, and local requirements.

IX. Vegetation (Urban Drainage and Flood Control District, Denver, Colorado, 2005)

Bottom vegetation provides erosion control and sediment entrapment. Basin bottom, berms, and side slope areas may be planted with native grasses or with irrigated turf, depending on the local setting and needs. Refer to suggestions and guidelines in **Appendix A** for vegetation selection and planting design.

X. Inlet Protection (Urban Drainage and Flood Control District, Denver, Colorado, 2005)

Dissipate flow energy at basin's inflow point(s) to limit erosion and promote particle sedimentation.

XI. Access (Urban Drainage and Flood Control District, Denver, Colorado, 2005)

All-weather stable access to the bottom, forebay, and outlet works area shall be provided for maintenance vehicles. Grades should not exceed 10 percent along access paths, and a solid driving surface of gravel, rock, concrete, or gravel-stabilized turf should be provided.

**Design Procedure Form: Extended Dry Detention Basin (EDDB)
Main Worksheet**

Designer: _____
Checked By: _____
Company: _____

Date: _____
Project: **EXAMPLE**
Location: _____
Page: 1 of 3

I. Basin Water Quality Storage Volume

Step 1) Tributary area to EDDB, A_T (ac) A_T (ac) = **26.0**
Step 2) Calculate WQv using methodology in Section 6 WQv (ac-ft) = **1.62**
Step 3) Add 20 percent to account for silt and sediment deposition in the basin V_{design} (ac-ft) = **1.94**

IIa. Water Quality Outlet Type

Step 1) Set water quality outlet type Outlet Type = **2**
Type 1 = single orifice
Type 2 = perforated riser or plate
Type 3 = v-notch weir
Step 2) Proceed to Step IIb, IIc, or IId based on water quality outlet type selected

IIb. Water Quality Outlet, Single Orifice

Step 1) Depth of water quality volume at outlet, Z_{WQ} (ft) Z_{WQ} (ft) = **3.0**
Step 2) Average head of water quality volume over invert of orifice, H_{WQ} (ft)
 $H_{WQ} = 0.5 * Z_{WQ}$ H_{WQ} (ft) = **1.5**
Step 3) Average water quality outflow rate, Q_{WQ} (cfs)
 $Q_{WQ} = (WQ_v * 43,560) / (40 * 3,600)$ Q_{WQ} (cfs) = **0.49**
Step 4) Set value of orifice discharge coefficient, C_o
 $C_o = 0.66$ when thickness of riser/weir plate is \leq orifice diameter
 $C_o = 0.80$ when thickness of riser/weir plate is $>$ orifice diameter C_o = **0.66**
Step 5) Water quality outlet orifice diameter (minimum of 4 inches), D_o (in)
 $D_o = 12 * 2 * (Q_{WQ} / (C_o * \pi * (2 * g * H)^{0.5}))^{0.5}$ D_o (in) = **3.7**
(if orifice diameter $<$ 4 inches, use outlet type 2 or 3)
Step 6) To size outlet orifice for EDDB with an irregular stage-volume relationship, use the Single Orifice Worksheet

IIc. Water Quality Outlet, Perforated Riser

Step 1) Depth at outlet above lowest perforation, Z_{WQ} (ft) Z_{WQ} (ft) = **3.0**
Step 2) Recommended maximum outlet area per row, A_o (in²)
 $A_o = (WQ_v) / (0.013 * Z_{WQ}^2 + 0.22 * Z_{WQ} - 0.10)$ A_o (in²) = **2.4**
Step 3) Circular perforation diameter per row assuming a single column, D_1 (in) D_1 (in) = **1.75**
Step 4) Number of columns, n_c n_c = **1**
Step 5) Design circular perforation diameter (should be between 1 and 2 inches), C_{perf} (in) D_{perf} (in) = **1.75**
Step 6) Horizontal perforation column spacing when $n_c > 1$, center to center, S_c
If $D_{perf} \geq 1.0$ inch, $S_c = 4$ S_c (in) = **N/A**
Step 7) Number of rows (4" vertical spacing between perforations, center to center), n_r n_r = **9**

Design Procedure Form: Extended Dry Detention Basin (EDDB)

Main Worksheet

Designer: _____
 Checked By: _____
 Company: _____

Date: _____
 Project: **EXAMPLE**
 Location: _____
 Page: 2 of 3

II. Water Quality Outlet, V-notch Weir

- Step 1) Depth of water quality volume above permanent pool, Z_{WQ} (ft) Z_{WQ} (ft) = **3.0**
- Step 2) Average head of water quality pool volume over invert of v-notch, H_{WQ} (ft)
 $H_{WQ} = 0.5 \cdot Z_{WQ}$ H_{WQ} (ft) = **1.5**
- Step 3) Average water quality pool outflow rate, Q_{WQ} (cfs)
 $Q_{WQ} = (WQv \cdot 43,560) / (40 \cdot 3,600)$ Q_{WQ} (cfs) = **0.49**
- Step 4) V-notch weir coefficient, C_v C_v = **2.5**
- Step 5) V-notch weir angle, θ (deg)
 $\theta = 2 \cdot (180/\pi) \cdot \arctan(Q_{WQ} / (C_v \cdot H_{WQ}^{5/2}))$
 V-notch angle should be at least 20 degrees. Set to 20 degrees if calculated angle is smaller. θ (deg) = **8**
- Step 6) Top width of V-notch weir, W_v (ft)
 $W_v = 2 \cdot Z_{WQ} \cdot \tan(\theta/2)$ W_v (ft) = **0.43**
- Step 7) To calculate v-notch angle for EDDB with an irregular stage-volume relationship, use the V-notch Weir Worksheet

III. Flood Control

Refer to APWA Specifications Section 5608

IV. Trash Racks

- Step 1) Total outlet area, A_{ot} (in²) A_{ot} (in²) = **21.5**
- Step 2) Required trash rack open area, A_t (in²)
 $A_t = A_{ot} \cdot 77 \cdot e^{-(U \cdot 1.24 \cdot U)}$ for single orifice outlet
 $A_t = (A_{ot} / 2) \cdot 77 \cdot e^{-(U \cdot 1.24 \cdot U)}$ for orifice plate outlet
 $A_t = 4 \cdot A_{ot}$ for v-notch weir outlet A_t (in²) = **668**

V. Basin Shape

- Step 1) Length to width ratio should be at least 3:1 (L:W) wherever practicable (L:W) = **3.0**
- Step 2) Low flow channel side lining Concrete: **X**
 Soil / riprap: **—**
 No low flow channel: **—**
- Step 3) Top stage floor drainage slope (toward low flow channel), S_{fs} (%) S_{fs} (%) = **2.0**
 Top stage depth, D_{fs} (ft) D_{fs} (ft) = **1.5**
- Step 4) Bottom stage volume, V_{bs} (ac-ft) V_{bs} (% of WQv) = **15%**
 V_{bs} (ac-ft) = **0.24**

**Design Procedure Form: Extended Dry Detention Basin (EDDB)
Main Worksheet**

Designer: _____
 Checked By: _____
 Company: _____

Date: _____
 Project: **EXAMPLE**
 Location: _____
 Page: 3 of 3

VI. Forebay (Optional)

Step 1) Volume should be greater than 10% of WQv Min Vol_{FB} (ac-ft) = **0.19**
 Step 2) Forebay depth, Z_{FB} (ft) Z_{FB} (ft) = **1.5**
 Step 3) Forebay surface area, A_{FB} (ac) Min A_{FB} (ac) = **0.13**
 Step 4) Paved/hard bottom and sides? **Yes**

VII. Basin side slopes

Basin side slopes should be at least 4:1 (H:V) Side Slope (H:V) = **4.0**

VIII. Dam Embankment side slopes

Dam Embankment side slopes should be at least 3:1 (H:V) Dam Embankment (H:V) = **3.0**

IX. Vegetation

Check the method of vegetation planted in the EDDB or describe "other"
 Native Grass
 Irrigated Turf Grass
 Other: _____

X. Inlet Protection

Indicate method of inlet protection/energy dissipation at EDDB inlet **Riprap apron**

XI. Access

Indicate that access has been provided for maintenance vehicles **Yes**

**Design Procedure Form: Extended Dry Detention Basin (EDDB)
Main Worksheet**

Designer: _____
Checked By: _____
Company: _____

Date: _____
Project: _____
Location: _____
Page: 1 of 3

I. Basin Water Quality Storage Volume

- Step 1) Tributary area to EDDB, A_T (ac) A_T (ac) = _____
- Step 2) Calculate WQv using methodology in Section 6 WQv (ac-ft) = _____
- Step 3) Add 20 percent to account for silt and sediment deposition in the basin V_{design} (ac-ft) = _____

IIa. Water Quality Outlet Type

- Step 1) Set water quality outlet type Outlet Type = _____
 Type 1 = single orifice
 Type 2 = perforated riser or plate
 Type 3 = v-notch weir
- Step 2) Proceed to Step IIb, IIc, or IId based on water quality outlet type selected

IIb. Water Quality Outlet, Single Orifice

- Step 1) Depth of water quality volume at outlet, Z_{WQ} (ft) Z_{WQ} (ft) = _____
- Step 2) Average head of water quality volume over invert of orifice, h_{WQ} (ft)
 $H_{WQ} = 0.5 * Z_{WQ}$ H_{WQ} (ft) = _____
- Step 3) Average water quality outflow rate, Q_{WQ} (cfs)
 $Q_{WQ} = (WQ_v * 43,560) / (40 * 3,600)$ Q_{WQ} (cfs) = _____
- Step 4) Set value of orifice discharge coefficient, C_o
 $C_o = 0.66$ when thickness of riser/weir plate is \leq orifice diameter
 $C_o = 0.80$ when thickness of riser/weir plate is $>$ orifice diameter C_o = _____
- Step 5) Water quality outlet orifice diameter (minimum of 4 inches), D_o (in)
 $D_o = 12 * 2 * (Q_{WQ} / (C_o * \pi * (2 * g * H)^{0.5}))^{0.5}$
 (if orifice diameter $<$ 4 inches, use outlet type 2 or 3) D_o (in) = _____
- Step 6) To size outlet orifice for EDDB with an irregular stage-volume relationship, use the Single Orifice Worksheet

IIc. Water Quality Outlet, Perforated Riser

- Step 1) Depth at outlet above lowest perforation, Z_{WQ} (ft) Z_{WQ} (ft) = _____
- Step 2) Recommended maximum outlet area per row, A_o (in²)
 $A_o = (WQ_v) / (0.013 * Z_{WQ}^2 + 0.22 * Z_{WQ} - 0.10)$ A_o (in²) = _____
- Step 3) Circular perforation diameter per row assuming a single column, D_1 (in) D_1 (in) = _____
- Step 4) Number of columns, n_c n_c = _____
- Step 5) Design circular perforation diameter (should be between 1 and 2 inches), D_{perf} (in) D_{perf} (in) = _____
- Step 6) Horizontal perforation column spacing when $n_c > 1$, center to center, S_c
 If $D_{perf} \geq 1.0$ inch, $S_c = 4$ S_c (in) = _____
- Step 7) Number of rows (4" vertical spacing between perforations, center to center), n_r n_r = _____

**Design Procedure Form: Extended Dry Detention Basin (EDDB)
Main Worksheet**

Designer: _____
Checked By: _____
Company: _____

Date: _____
Project: _____
Location: _____
Page: 2 of 3

II. Water Quality Outlet, V-notch Weir

- Step 1) Depth of water quality volume above permanent pool, Z_{WQ} (ft) Z_{WQ} (ft) = _____
- Step 2) Average head of water quality pool volume over invert of v-notch, H_{WQ} (ft)
 $H_{WQ} = 0.5 * Z_{WQ}$ H_{WQ} (ft) = _____
- Step 3) Average water quality pool outflow rate, Q_{WQ} (cfs)
 $Q_{WQ} = (WQV * 43,560) / (40 * 3,600)$ Q_{WQ} (cfs) = _____
- Step 4) V-notch weir coefficient, C_v C_v = _____
- Step 5) V-notch weir angle, θ (deg)
 $\theta = 2 * (180/\pi) * \arctan(Q_{WQ} / (C_v * H_{WQ}^{5/2}))$
 V-notch angle should be at least 20 degrees. Set to 20 degrees if calculated angle is smaller. θ (deg) = _____
- Step 6) Top width of V-notch weir, W_v (ft)
 $W_v = 2 * Z_{WQ} * \tan(\theta/2)$ W_v (ft) = _____
- Step 7) To calculate v-notch angle for EDDB with an irregular stage-volume relationship, use the V-notch Weir Worksheet

III. Flood Control

Refer to APWA Specifications Section 5608

IV. Trash Racks

- Step 1) Total outlet area, A_{ot} (in²) A_{ot} (in²) = _____
- Step 2) Required trash rack open area, A_t (in²)
 $A_t = A_{ot} * 77 * e^{-(0.124 * U)}$ for single orifice outlet
 $A_t = (A_{ot} / 2) * 77 * e^{-(0.124 * U)}$ for orifice plate outlet
 $A_t = 4 * A_{ot}$ for v-notch weir outlet A_t (in²) = _____

V. Basin Shape

- Step 1) Length to width ratio should be at least 3:1 (L:W) wherever practicable (L:W) = _____
- Step 2) Low flow channel side lining Concrete: _____
Soil / riprap: _____
No low flow channel: _____
- Step 3) Top stage floor drainage slope (toward low flow channel), S_{fs} (%) S_{fs} (%) = _____
 Top stage depth, D_{fs} (ft) D_{fs} (ft) = _____
- Step 4) Bottom stage volume, V_{bs} (ac-ft) V_{bs} (% of WQV) = _____
 V_{bs} (ac-ft) = _____

Design Procedure Form: Extended Dry Detention Basin (EDDB)
Main Worksheet

Designer: _____
Checked By: _____
Company: _____

Date: _____
Project: _____
Location: _____
Page: 3 of 3

VI. Forebay (Optional)

Step 1) Volume should be greater than 10% of WQv Min Vol_{FB} (ac-ft) = _____
Step 2) Forebay depth, Z_{FB} (ft) Z_{FB} (ft) = _____
Step 3) Forebay surface area, A_{FB} (ac) Min A_{FB} (ac) = _____
Step 4) Paved/hard bottom and sides? _____

VII. Basin side slopes

Basin side slopes should be at least 4:1 (H:V) Side Slope (H:V) = _____

VIII. Dam Embankment side slopes

Dam Embankment side slopes should be at least 3:1 (H:V) Dam Embankment (H:V) = _____

IX. Vegetation

Check the method of vegetation planted in the EDDB or describe "other" _____
___ Native Grass
___ Irrigated Turf Grass
___ Other: _____

X. Inlet Protection

Indicate method of inlet protection/energy dissipation at EDDB inlet _____

XI. Access

Indicate that access has been provided for maintenance vehicles _____

Variable Dictionary

<u>Variable</u>	<u>Units</u>	<u>Definition</u>
A _{ot}	in ²	Total open area of outlet structure
A _{FB}	ac	Forebay surface area
A _t	in ²	total required trash rack open area
A _T	ac	Tributary area to EDDB
C _o	none	Orifice discharge coefficient
C _v	none	V-Notch weir discharge coefficient
D _o	in	Water quality outlet orifice diameter
D ₁	in	Circular perforation diameter per row, assuming a single column, for perforated riser or weir plate
D _{perf}	in	Design circular perforation diameter for perforated riser or weir plate
D _{ts}	ft	EDDB top stage depth
H _{WQ}	ft	Average head of WQv over invert of water quality outlet
n _c	none	Number of columns of perforations for perforated riser or weir plate
n _r	none	Number of rows of perforations for perforated riser or weir plate
θ	deg	V-Notch weir angle
Q _{WQ}	cfs	Average WQv outflow rate
S _c	in	Horizontal perforation column spacing for perforated riser or weir plate
S _{ts}	%	Top stage floor drainage slope toward low flow channel
V _{bs}	ac-ft	Bottom stage volume
V _{design}	ac-ft	Design volume of EDDB, accounts for 20% basin filling with sediment
Vol _{FB}	ac-ft	Pre-sedimentation forebay volume
WQV	ac-ft	Water quality volume
W _v	ft	V-notch weir width
Z _{FB}	ft	Forebay depth
Z _{WQ}	ft	Depth of WQv above invert of outlet

Part 2b.(v) Water quality outlet orifice diameter derivation from Orifice Equation

$$Q_{WQ} = C_o * A * (2 * g * H)^{0.5} \quad \text{(Orifice Equation)}$$

$$Q_{WQ} = C_o * (\pi * D_o^2 / 4) * (2 * g * H)^{0.5} \quad \text{(Do = orifice diameter in feet)}$$

$$D_o = \{4 * Q_{WQ} / [C_o * \pi * (2 * g * H)^{0.5}]\}^{0.5} \quad \text{(Solve for Do, in feet)}$$

$$D_o = 12 * 2 * \{Q_{WQ} / [C_o * \pi * (2 * g * H)^{0.5}]\}^{0.5} \quad \text{(Simplify and convert Do to inches)}$$

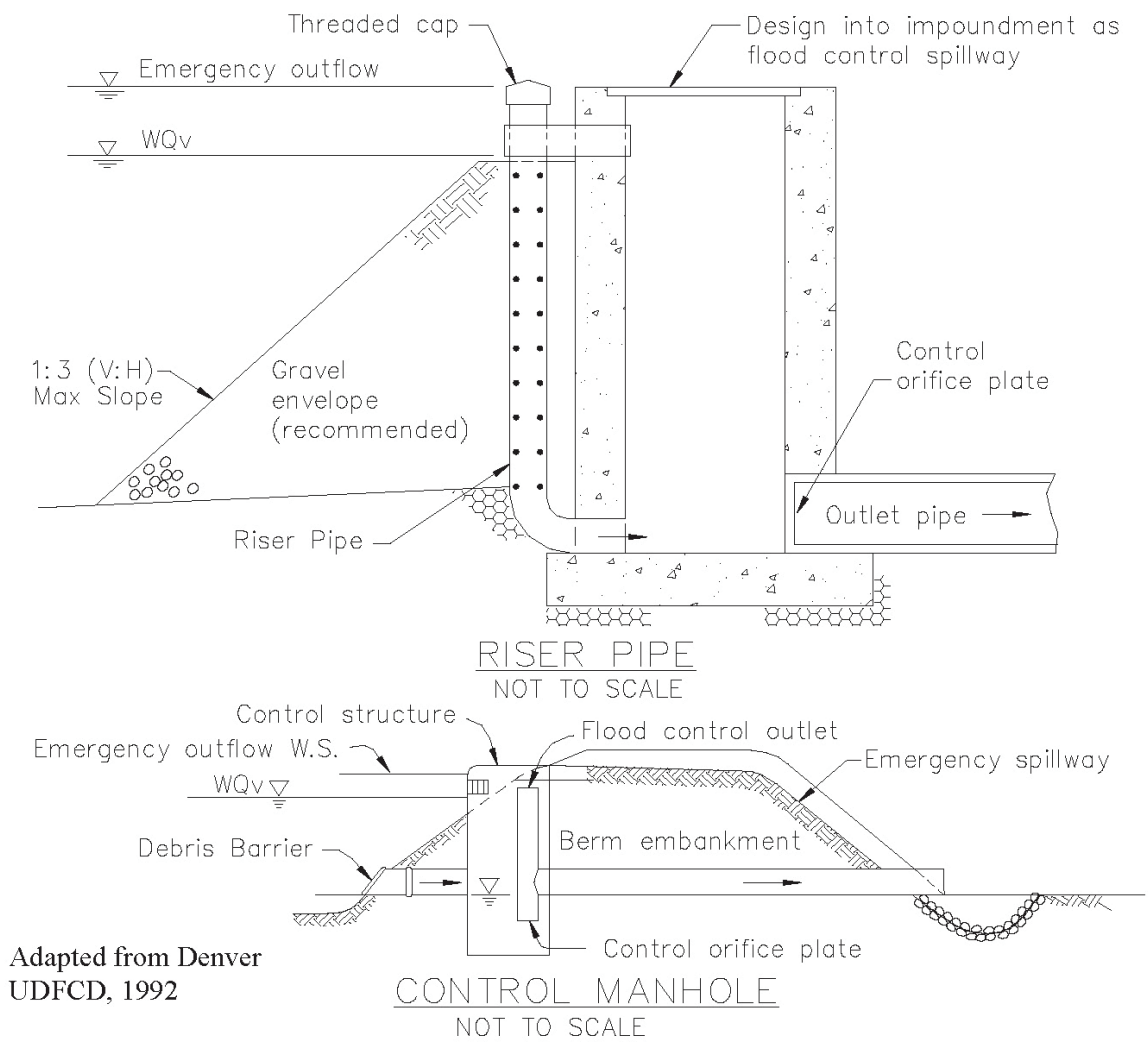

Adapted from Denver
UDFCD, 1992

Figure 8.23 - Sandpipe Outlet Structure

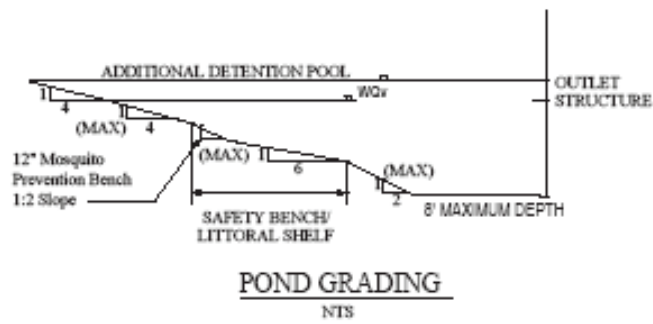
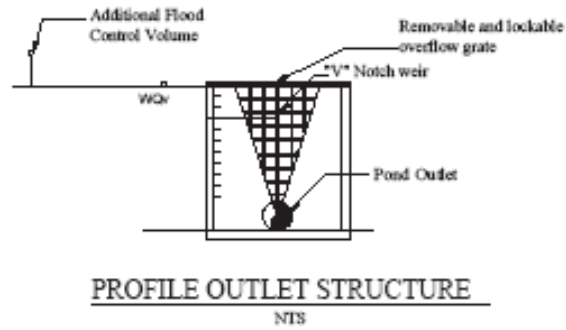
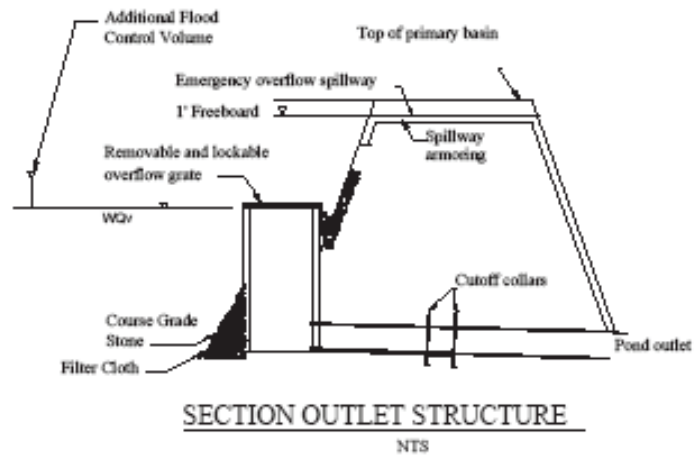
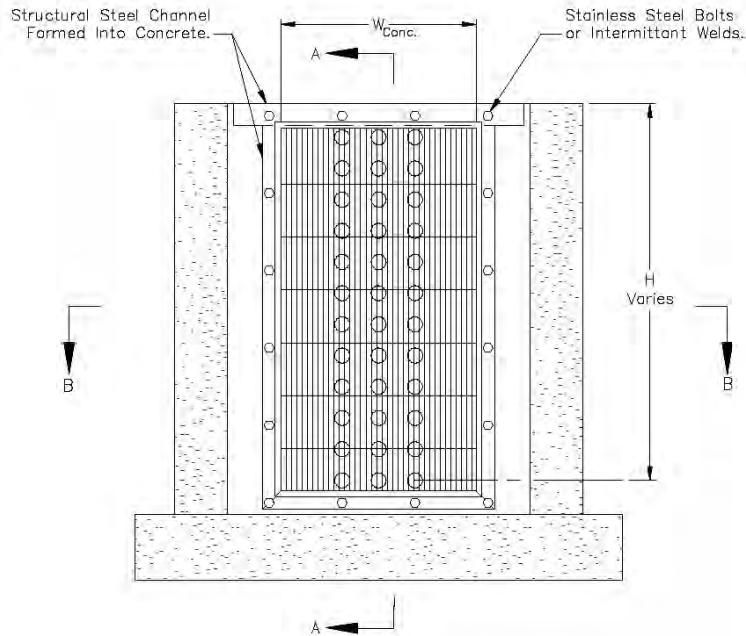

Figure 8.24 - "V" Notch Weir Outlet Structure (3)



Elevation

WQv Trash Racks:

1. Well-screen trash racks shall be stainless steel and shall be attached by intermittent welds along the edge of the mounting frame.
2. Bar grate trash racks shall be aluminum and shall be bolted using stainless steel hardware.
3. Trash Rack widths are for specified trash rack material. Finer well-screen or mesh size than specified is acceptable, however, trash rack dimensions need to be adjusted for materials having a different open area/gross area ratio (R value)
4. Structural design of trash rack shall be based on full hydrostatic head with zero head downstream of the rack.

Overflow Trash Racks:

1. All trash racks shall be mounted using stainless steel hardware and provided with hinged and lockable or boltable access panels.
2. Trash racks shall be stainless steel, aluminum, or steel. Steel trash racks shall be hot dip galvanized and may be hot powder painted after galvanizing.
3. Trash Racks shall be designed such that the diagonal dimension of each opening is smaller than the diameter of the outlet pipe.
4. Structural design of trash rack shall be based on full hydrostatic head with zero head downstream of the rack.

Adapted from Denver Urban Drainage and Flood Control District

Figure 8.25 - WQv Outlet Trash Rack Design (3)

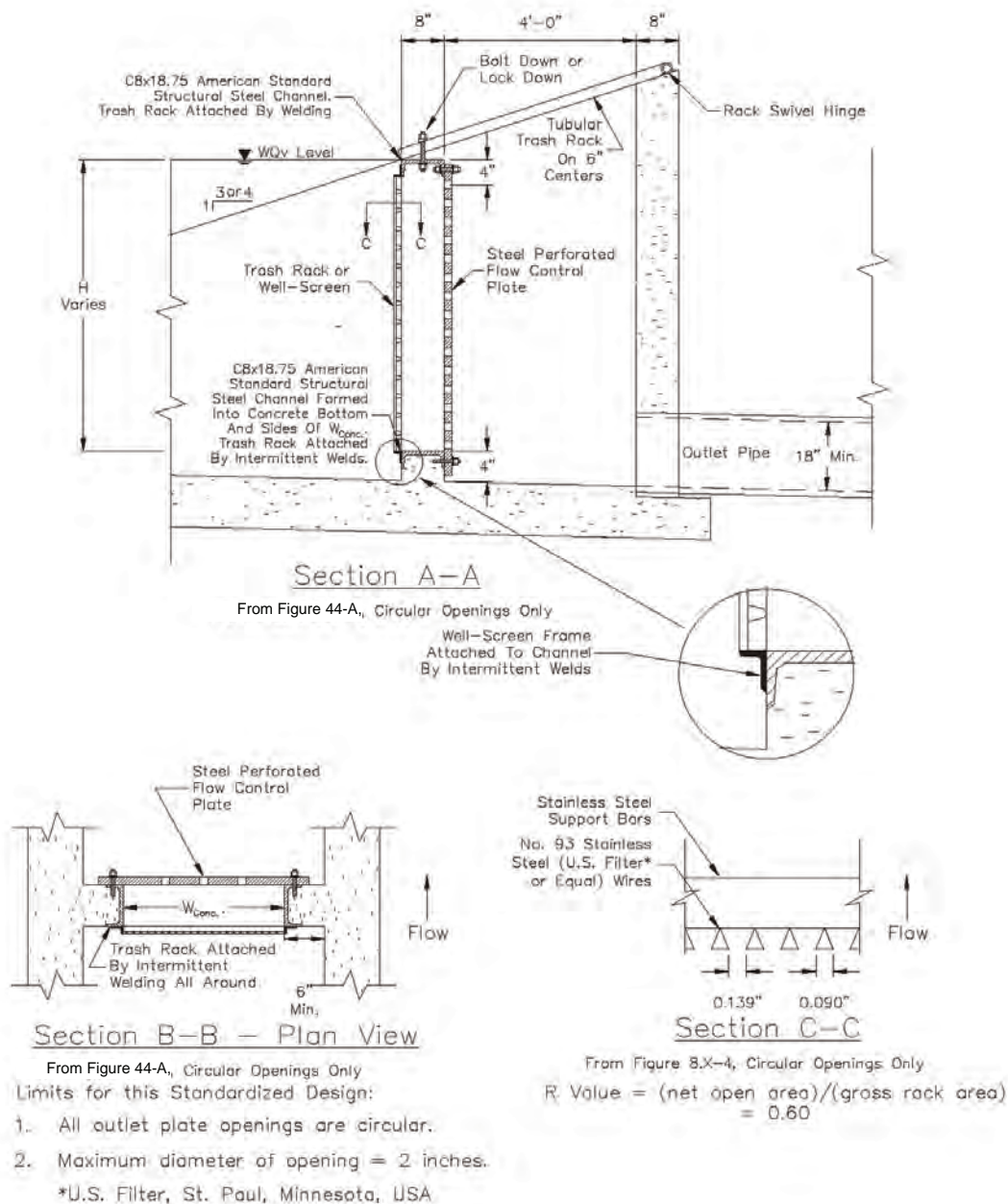

Adapted from Denver Urban Drainage and Flood Control District

Figure 8.26 - WQ_v Outlet Trash Rack Design (3)

8.13 TURF SWALES

8.13.1 Description

Turf grass swales are broad, shallow, natural, or constructed channels with a dense stand turf grass covering the side slopes and channel bottom. They slowly convey stormwater runoff, and in the process promote infiltration,, reduce flow velocities, and pretreat stormwater. Turf swales can have either parabolic or trapezoidal cross sections. Turf grass swales are intended to be used as a substitute for traditional pipe systems to treat and convey roadway drainage.

8.13.2 General Application



Picture Source: Olsson Associates

Targeted Constituents

Sediment	●
Nutrients	◐
Trash	○
Metals	◐
Bacteria	◐
Oil and Grease	○
Organics	◐

Legend (Removal Effectiveness)

High	Medium	Low
●	◐	○

Rather than routing stormwater runoff into a lined channel or into a curb-gutter system, consider using a natural conveyance channel. Turf swales promote infiltration and also help settle many particulate contaminants. Do not use channels as a BMP component to convey deep concentrated flow; channels are only effective conveying shallow concentrated flow. Take care to identify the proper location for a Turf swale. Minimizing disturbance to the area (for example, avoiding application of pesticides and herbicides) maintains the channel's ability to remove contaminants. Select grass species that tolerate frequent inundation.

8.13.3 Advantages

- Constructed less expensively and maintained more easily than underground pipes
- Improve water quality by infiltration, sedimentation and biological uptake
- Reduce total volume of runoff to surrounding streams and rivers
- Minimize erosion by slowing the conveyance of water.

8.13.4 Disadvantages

- May require irrigation to maintain proper vegetative cover for controlling erosion and reducing pollution in the channel
- May not be feasible to implement after development has occurred
- Require relatively large areas, proper sloping, and connection with other conveyance components

- Not designed to be the fastest conveyance method and, therefore, require exact placement and design to minimize risk of flooding.

8.13.5 Design Considerations

Source: Metropolitan Council Environmental Services. 2001 *Minnesota Urban Small Sites BMP Manual*, St. Paul, MN.

The design approach for sizing turf swales is based on conveying the water quality flow at a shallow depth (<4"). This methodology incorporates a flowrate-based sizing criteria for the water quality, 1%, and 10% frequency storm. Provide bypass for high flows if the swale cannot be stable during the 10% or greater storm.

The following design specifications are summarized in **Table 8.9**.

Table 8.9
Design Summary for Turf Swales

Parameter	Swale Design Criteria
Energy Dissipation	Required if incoming flow is piped
Side Slopes	4:1 recommended; 3:1 maximum
Longitudinal Slope	1-2%, velocity for 50% storm must not exceed erosive velocity for turf.
Underlying soil bed	Undisturbed soils equal to the swale width. No underdrain system.
Drainage Area	5 acres or less
Depth	WQ _r depth of 4 inches or less.
Flow Velocity	< 1 fps for WQ event; 4 fps for 2-yr storm
Minimum Swale Length	Length based on a 5 minute residence time, or 100 feet, whichever is greater.
Bottom Width	2-foot minimum; 6-foot maximum
Manning's "n"	0.15 for water quality treatment (depth < 4 inches); varies from 0.15 – 0.03 for depths of 4 to 12 inches; 0.03 minimum for depths > 12 inches

8.13.5.1 Shape and Slope

- The swales should generally be trapezoidal in shape, although a parabolic shape is also acceptable (provided the width is equal to or greater than the design bottom width for a trapezoidal cross section). The criteria presented in this section assume a trapezoidal cross section.
- For the trapezoidal cross section, size of the bottom width between two and six feet. The two feet minimum allows for construction considerations and ensures a minimum filtering surface for water quality treatment. The six feet maximum reduces the likelihood of flow channelization within a portion of the swale.
- The side slopes of the channel should be no steeper than 3:1 for maintenance and safety considerations. Flatter slopes are encouraged where adequate space is available to aid in providing pretreatment for lateral flows.
- The longitudinal slope of the swale should be moderately flat to provide the slowest flow rate possible. When natural topography necessitates, steeper slopes may be acceptable if check dams (vertical drops of 6 to 12 inches) are used. These structures will require additional energy dissipating measures and should be placed no closer than 50 to 100 foot interval.

8.13.6 Design Size and Soils

Source: Metropolitan Council Environmental Services. 2001 Minnesota Urban Small Sites BMP Manual, St. Paul, MN.

- Design swales to provide a shallow flow depth for the water quality storm (a maximum of 4 inches for the water quality flow is recommended), safely convey the 2 year storm with design velocities appropriate for the soil and cover types, and provide adequate capacity for the 10 year and 100 year storm with a minimum of 1 foot of freeboard if applicable.
- See that the soil bed below the swale consists of undisturbed soils. This area may be periodically inundated and remain wet for long periods of time.
- Do not construct turf swales in gravelly and coarse sandy soils that cannot easily support dense vegetation.
- In areas with steep slopes, employ turf swales in locations where they can be parallel to the contours.
- Size channels to convey the 10 and 100-year storm volumes and design channel slopes to prevent erosion during the 2-year storm events.
- Use outlet protection at any discharge point from turf swales to prevent scour at the outlet.
- Provide minimum freeboard above 100-year storm water surface profile (1.0 foot minimum or as required by local ordinance).
- Identify the swale bottom, width, depth, length, and slope necessary to convey the water quality flow rate with a shallow depth (approximate maximum of 4 inches).
- Compute the 2-year, 10-year, and 100-year frequency storm event peak discharges.
- Check the 10-year and 100-year velocity for erosive potential (adjust swale geometry, if necessary reevaluate WQv design parameters).
- Provide pretreatment to protect the filtering and infiltration capacity of the swale bed. Pretreatment can occur in a sediment forebay behind a check dam with a pipe inlet.
- Use check dams in turf swales to achieve flatter sections with slower velocities. V-notched weirs in the check dams can be utilized to direct flow and volumes.
- Design turf swales with trapezoidal or parabolic cross sections, and with side slopes no greater than 3:1 (horizontal:vertical) and bottom widths ranging from 2 to 6 feet.
- Check permissible velocities of selected vegetation to ensure the 2-year frequency storm is non-erosive.

8.13.6.1 Vegetative Cover

Source: Metropolitan Council Environmental Services. 2001 Minnesota Urban Small Sites BMP Manual, St. Paul, MN.

- Grass species selection will depend upon the duration of water inundation, soil type, and amount of light.
- Specify grass species resistant to periodic inundation and periodic drought
- Appropriate soil stabilization methods, such as mulch, blankets or mats should be used before the establishment of vegetation. Seeding, sodding, and other items related to establishing vegetation should be in accordance with accepted erosion-control and planning practices.

8.13.7 Maintenance and Inspections

Source: Metropolitan Council Environmental Services. 2001 Minnesota Urban Small Sites BMP Manual, St. Paul, MN.

The following is a partial list of actions to upkeep turf swales:

- Inspect swale several times the first few months to ensure plant species are establishing well. If not, reseed or plant an alternative species. Also, inspect the channel for erosion after every rainfall event and repair as necessary.
- If a forebay is used, inspect and remove excessive sediment, trash, and debris and dispose of in an appropriate location.
- Control vegetation by mowing or grubbing techniques (not by chemicals).
- If heavy sediment loading occurs, clean the channel to remove excess particulates.

8.13.8 Design Example

8.13.8.1 Calculations

Step 1 - Find peak flowrate (Q) for tributary area to swale for water quality rainfall event using Rational Method.

$$Q_{WQ} = K \cdot C \cdot i \cdot A$$

Where:

Q = Peak flowrate of runoff (cfs)

C = Runoff Coefficient = $0.3 + 0.6 \times I$, where I is percent impervious divided by 100

I = Rainfall intensity for water quality rainfall event at the duration equal to the calculated time of concentration (inches/hr) from Section 6.

A = Tributary drainage area (acres)

K = Dimensionless coefficient to account for antecedent precipitation

1.0 for the Water Quality Storm

Step 2 - Solve Manning's equation for a specified variable. For this example, we will calculate flowrate at the maximum allowable depth to verify the swale can carry the proposed peak flowrate. This step is most easily accomplished using a spreadsheet or solver program.

Step 3 - Solve $V = Q/A$ for velocity using calculated variable and Q calculated in Step 1. If V is greater than 1 ft/s, the width of channel, longitudinal slope of channel, or Manning's n value may need to be adjusted to obtain a velocity less than 1 fps, and therefore appropriate for shallow flow.

Step 4 - Solve for minimum swale length: $L = V \times 5 \text{ min} \times 60 \text{ sec/min}$. Minimum 100 feet.

Step 5 - Find peak flowrate (Q) for tributary area to swale for the 50% rainfall event using Rational Method.

Step 6 - Solve $V = Q/A$ for velocity using calculated area and Q calculated in Step 4. If V is greater than 4 ft/s, the shape of channel or longitudinal slope of channel may need to be adjusted to obtain a non-erosive velocity less than 4 fps.

Note that an agency may require that a swale also be designed for conveyance of a defined design storm (e.g. 10% or 1% storm event). Additional calculations may be necessary to size the swale for other larger events.

8.13.8.2 Design Example

A 5.0 acre site is being developed by a church (C=0.75) in the Kansas City Metro. 0.25 acres of the site will be tributary to a proposed 4-foot turf swale, with a Manning's n value of 0.03 and side slopes at 5:1. Assume a time of

concentration of 10 minutes to the swale. Proposed longitudinal slope is 2.0-percent. Design the swale for the water quality rainfall event.

Step 1 - Calculate the water quality rainfall event Q using the Rational Method. Methodology can be found in Section 6 of this manual.

$$Q = (1.0) * (0.75) * (1.68 \text{ in/hr}) * (0.25 \text{ acre}) = 0.32 \text{ cfs}$$

Step 2 - Using a solver program, depth in the swale was calculated for the peak Water Quality flow using Manning's equation.

Trapezoidal (5:1) Swale Example

n value	Iterated Depth (D) feet	Width (W) feet	Area (A) (ft ²)	Wetted Perimeter (ft)	Hydraulic Radius (R _n) (ft)	Longitudinal Slope (ft/ft)	Q (CFS)
0.03	0.06	5.50	0.32	6.07	0.053	0.02	0.32

The proposed swale can carry the Water Quality peak flow of 0.32 cfs below the maximum 4-inch depth.

Step 3 - Calculate Velocity.

$$V = (0.32 \text{ cfs}) / (0.32 \text{ ft}^2) = 1.0 \text{ ft/s. Therefore the proposed swale meets recommendations for the Water Quality Storm.}$$

Step 4 - Calculate Length

$$V = 1 \text{ ft/s} \times 5 \text{ min} \times 60 \text{ sec/min} = 300 \text{ ft}$$

Step 5 - Calculate the 50% rainfall event Q using the Rational Method. Methodology can be found in APWA 5602.

$$Q = (1.0) * (0.75) * (4.30 \text{ in/hr}) * (0.25 \text{ acre}) = 0.81 \text{ cfs}$$

Step 6 - Using a solver program, 50% storm event flow depth and area in the swale were calculated using Manning's equation.

Trapezoidal (5:1) Swale Example

n value	Depth (D) feet	Width (W) feet	Iterated Area (A) ft ²	Wetted Perimeter (ft)	Hydraulic Radius (H _R) (ft)	Long Slope (ft/ft)	Q (CFS)
0.03	0.10	5.50	0.58	6.49	0.89	0.02	0.81

$$V = (0.81 \text{ cfs}) / (0.58 \text{ ft}^2) = 1.40 \text{ ft/s. This is less than 4 ft/s, and therefore meets recommendations for non-erosive velocities.}$$

8.14 PROPRIETARY MEDIA FILTRATION

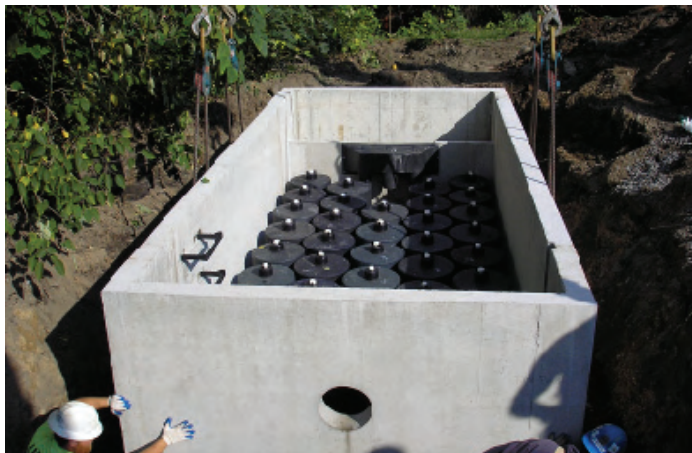

Picture Source: CONTECH Stormwater Solutions Inc.

Targeted Constituents

Sediment	●
Nutrients	◐
Trash	●
Metals	●
Bacteria	◐
Oil and Grease	●
Organics	●

Legend (Removal Effectiveness)

High	Medium	Low
●	◐	○

8.14.1 Description

Proprietary media filtration systems are available in a number of configurations and designs, but all remove pollutants from stormwater by directing the runoff flow through a bed of media. This media may be chemically inert, targeting suspended solids particles and associated particulate pollutants, or may utilize ion exchange or other sorption processes to remove dissolved pollutant constituents.

8.14.2 General Application

As state and local regulations increase pollutant removal requirements for BMPs, media filtration systems have emerged among the highest performing proprietary processes for stormwater treatment. These systems are available from a variety of manufacturers and can be designed to address most of the common pollutants associated with stormwater runoff. Typically, the filtration media is housed in some standardized unit such as a cartridge or pack, allowing a modular configuration which simplifies system sizing.

Media filtration systems often utilize sedimentation as an integrated pre-treatment process. Heavier particles settle out on the floor of the system and do not contribute to loading of the filter surface. Such devices should be placed in an offline configuration such that flows exceeding system design are diverted and do not cause resuspension of settled material.

There are various types of media that can be used for filtration. Media are often selected to address specific types of pollutants. In many cases a media blend is ideal for general purpose treatment.

- **Inert Media** - provide treatment for sediment and associated pollutants. There is no chemical process that takes place. Perlite and sand are common examples of inert media. Straining and sedimentation within the media volume are the primary mechanisms of removal as water is forced to take a tortuous path through the media bed. Media gradation is a key variable in inert filters, with finer media able to remove smaller particles. However, a corresponding increase in head loss typically results in lower flow rates through finely graded media.
- **Active Media** – utilize chemical processes such as ion exchange, adsorption, and absorption to remove dissolved constituents such as metals or nutrients at the molecular level. Active media include zeolite, leaf compost, peat, activated alumina, synthetic resins, and granular activated carbon (GAC). These media are selective in terms of the pollutants they remove, and careful consideration must be taken in pairing media

with the target pollutant. When designing systems with active media, hydraulic treatment capacity is dependent on the contact time required for the respective chemical process.

TABLE 8.10
Pollutant Groups Targeted by Common Media Types

	Perlite	Leaf Compost or Peat	Zeolite	GAC
Sediments	●	●		
Oil & Grease	●	●		
Soluble Metals		●	●	
Organics		●		●
Nutrients	●		●	

8.14.3 Advantages

- Media filters are a highly versatile type of treatment device and can provide very high level of treatment for most common stormwater pollutants.
- Media filters can typically be configured in underground vaults, allowing improved site usage when compared to above-ground systems.
- Modular system designs can accommodate a variety of applications and can be sized for stand-alone treatment, or as part of a treatment trains. This design flexibility also allows system sizing to accommodate very large and very small treatment areas.
- When configured with specialized media, filter systems are able to remove high levels of dissolved pollutants typically not treated by traditional BMPs.

8.14.4 Disadvantages

- Where land costs are moderate, systems typically are more expensive than traditional, above-ground systems.
- Like all proprietary BMPs, the design of these systems is specific to the manufacturer. As such, approval should be subject to performance verification, where possible in field conditions.
- Maintenance costs and requirements may vary greatly, adding to the initial systems cost.

8.14.5 Siting and Design Considerations

While manufacturers' designs differ, filter configurations can be evaluated by comparing fundamental parameters between different types of filters. These parameters relate to the velocity and residence time of water through the filter media as well as the pollutant loading capacity of the filter unit.

- **Specific Flow Rate – Surface Area (flow/media surface area):**The flow rate per unit area of media surface area is important because the surface of the media can become occluded before the entire volume of media is exhausted. Ensuring there is adequate surface area for the design flow is a key parameter to ensure longevity.
- **Specific Flow Rate – Media Volume (flow/media volume):**Eventually, all of the open area within the media will collect pollutants. Once full, the flow rate will decrease and the system will operate below hydraulic

design. The flow rate per unit volume of media is a measure of performance and longevity – lower specific flow rates imply greater longevity.

- Percent Open Area: Typically there is a “screen” to hold the media within the filter unit (often a cartridge or module). The open area of the “screen” is important to prevent fouling the media surface area. The actual open area of a filter is determined by multiplying the total filter surface area by the percent open area. Systems with larger actual open areas will be less likely to fail due to surface fouling.
- Loading (mass/volume): Every filter can hold a certain amount of sediment and pollutants before the flow rate at a given head begins to decrease. Data from loading tests should be available to provide mass-loading based sizing. This data will provide the information required to ensure the system will operate at design flow rates for the desired maintenance interval.

8.14.6 Maintenance

Manufacturers will specify maintenance guidelines and procedures for their respective systems. Typically, media filters are designed for an annualized maintenance cycle, but filter longevity is site-dependant and difficult to predict. There are, however, several important design elements that can provide an indication of maintenance and longevity.

- Surface Cleaning – prolongs the longevity of filter systems by maintaining the percent open area. Siphon-actuated media filters have demonstrated the ability to passively clean the surface of the filter with hydraulic turbulence caused by air bubbles which are created when the siphon breaks. Backflush mechanisms also provide surface cleaning.
- “Dry” Media – it is important the media is above any permanent pool that may exist between storms. This significantly reduces the chance that biological growth will occlude the media and shorten the maintenance interval.
- Dry Sump – some media filters may have a sump located below the cartridges. It is important that the sump is able to drain completely between storms. This reduces the volume of water to be disposed of after maintenance. It also prevents captured organic material from decomposing and washing through the system, as well as providing some vector control.

8.14.7 Design Example

Design of proprietary media filtration systems must be completed by the manufacturer.

8.15 HYDRO DYNAMIC SEPARATION



Picture Source: CONTECH Stormwater Solutions Inc.

Targeted Constituents

Sediment	●
Nutrients	○
Trash	●
Metals	○
Bacteria	○
Oil and Grease	●
Organics	○

Legend (Removal Effectiveness)

High	Medium	Low
●	●	○

8.15.1 Description

Hydrodynamic separators, also known as swirl concentrators or vortex separators, describe a wide variety of proprietary devices that have been developed in recent years. They are modifications of traditional oil/particle separators that typically target coarse solids and large oil droplets. While most of these systems utilize vortex-enhanced sedimentation, others use circular screening systems or engineered cylindrical sedimentation.¹ Vortex separation was originally developed for use in combined sewer overflows.

8.15.2 General Application

Hydrodynamic separators are typically used for water quality enhancement in urban and ultra-urban areas where surface BMPs are not feasible. Most are flow-through structures in that the design rate of flow into the structure is regulated by the inflow pipe or structure hydraulics as opposed to BMPs designed to store the entire water quality volume.²

These systems differ from traditional wet vaults in that the primary separation chamber is round rather than rectangular, forcing water to move in a circular fashion. Use of a circular flow path instead of straight line makes it possible to obtain significant removal of suspended sediments and attached pollutants with less space required.³ Additionally, secondary flow paths caused by a friction-induced pressure differential between the surface and bottom of the separator aid in increasing the path length and settling opportunity of entrained particles.⁴ Oil, grease, and floatable trash and debris collect at the surface of the separator.

Most hydrodynamic separation systems available in an on-line configuration utilize a diversion weir or other flow control structure to facilitate internal bypass of flows that exceed system design capacity. These structures are configured to minimize turbulence within the primary separation chamber in order to prevent trapped sediment from becoming resuspended.

8.15.3 Advantages

- Hydrodynamic separators can provide effective removal of coarse particles in less space and at less cost than traditional wet or dry basins.
- These systems can provide effective sediment removal over a wide range of flow conditions.

-
- Small footprint requirement for installation makes hydrodynamic separators particularly suitable in retrofit applications, particularly in highly developed areas.¹
 - Maintenance costs and requirements are typically less than with traditional settling basins.
 - When used as pretreatment in treatment train applications, hydrodynamic separators can prolong the maintenance interval of downstream systems.

8.15.4 Disadvantages

- Hydrodynamic separators do not remove dissolved pollutants.
- Regular maintenance is required to avoid resuspension of trapped pollutants.
- Systems that have standing pools of water between storms may cause some level of concern about mosquito breeding.³
- These systems do not effectively remove fine particles (on the order of 50 microns in diameter and less).

8.15.5 Siting and Design Considerations

Design and subsequent performance expectations differ from manufacturer to manufacturer, but the following design considerations hold for most hydrodynamic separators that are currently available.

- Hydrodynamic separators should be used in an off-line configuration where conditions permit. An upstream diversion structure should be installed to bypass around the unit those flows that exceed the system design capacity.
- When off-line configurations are not possible, care should be taken to distinguish between system treatment capacity and system hydraulic capacity. Failure to recognize the difference may lead to significant undersizing of the system.³ Undersized systems placed in an in-line configuration may be unable to convey peak flows internally without causing resuspension of settled material.
- Headloss differs with the product and the model but is generally on the order of one foot or less.³
- Like all proprietary BMPs, the design of these systems is specific to the manufacturer. As such, approval should be subject to performance verification, where possible in field conditions.
- When treatment goals are measured in terms of TSS removal, a target particle size should be identified to assist in separator sizing. Most manufacturers base their performance claims on laboratory testing with sediment of a specified particle size distribution.

8.15.6 Maintenance

- Maintenance of hydrodynamic separators consists of the removal of trapped material with a vacuum truck. As such, these systems should be installed in locations accessible to such equipment.
- Typical maintenance interval is one year; however, site-specific experience may indicate the need for more or less frequent maintenance.³
- Design plans for hydrodynamic separators should include inspection and maintenance requirements and schedules.¹

8.15.7 Design Example

Design specifications for hydrodynamic separators depend on the particular device and must be completed by the manufacturer.

8.16 CATCH BASIN INSERTS



Picture Source: CONTECH Stormwater Solutions Inc. and Interstate Products, Inc.

Targeted Constituents

Sediment	●
Nutrients	○
Trash	●
Metals	○
Bacteria	○
Oil and Grease	●
Organics	○

Legend (Removal Effectiveness)

High	Medium	Low
●	◐	○

8.16.1 Description

Catch Basin Inserts (CBIs) are manufactured filters or fabrics designed to remove trash, debris, and coarse sediment from stormwater runoff directly at the storm drain inlet structure. Some CBIs may also be fabricated to absorb oils. Typically, CBIs are installed beneath a catch basin inlet grate by mounting directly to the structure wall or by suspension from the lip of the inlet.

8.16.2 General Application

CBIs can be used to improve the quality of urban runoff coming from roads, parking lots, residential neighborhoods, commercial areas, and industrial sites, and are often considered a relatively inexpensive option for retrofit applications. CBIs are typically not applicable as a stand-alone treatment option. They are best used in conjunction with other BMPs where they can reduce the loading to and increase the maintenance of downstream applications such as media filtration and infiltration.

The most basic CBIs consist of a bag or sock of polypropylene intended for vertical drain inlets. Other types consist of a box constructed of plastic or wire mesh which acts as a frame for manufactured fabrics. Some CBIs are equipped with a type of filter media used to target specific pollutants (i.e. activated carbon, porous polymer, or treated cellulose). Manufacturers' specifications should be closely compared and adhered to for on-site application.

8.16.3 Advantages

- Catch Basin Inserts are among the least expensive proprietary BMPs, with initial costs of individual inserts ranging from less than \$100 to about \$2,000.¹
- CBIs do not require additional space considerations as storm drain inlet structures are already a component of standard drainage systems.¹
- CBIs are typically visible from the surface, allowing easy inspection and maintenance.
- When properly maintained, CBIs are an effective means of preventing organic and vegetative debris from entering the storm drain system, where these pollutants often decompose to release soluble nutrient species.

8.16.4 Disadvantages

- Sediments tend to blind or clog the fabric or filter media of the Catch Basin Insert, making this type of BMP very maintenance-intensive.² These problems may be compounded by street sanding or heavy vegetation.
- Under high runoff rates, CBIs may perform ineffectively or even release pollutants to the drainage system due to very short contact times and potential for flushing previously trapped materials.³
- Frequent maintenance and/or replacement needs may offset the initial low costs of these BMPs.

8.16.5 Siting and Design Considerations

The following guidelines should be considered when applying Catch Basin Inserts:

- CBIs have a limited ability to remove stormwater pollutants and should not be used as a stand-alone device.
- Two outlets should typically be designed into the device—one for treated stormwater flows, and a second for stormwater flows that exceed the capacity of the device.³
- CBIs are most effective at capturing coarse sediment and debris associated with unpaved areas.⁴
- CBIs are not generally effective at capturing metals or pollutants associated with silt- or clay-sized particles.⁴
- Inserts designed to absorb oil and grease have been found to effectively reduce these concentrations when newly installed; however, after some use, the effective reduction capacity has been found to drop considerably.⁴
- Due to the number and variety of CBIs commercially available, design and installation information should be obtained by the manufacturer to ensure optimal treatment of targeted pollutants.
- CBIs should be sited to avoid pooling of water in or around the storm drain inlet structure to avoid the breeding of mosquitoes and other potentially disease-carrying vectors.
- For CBIs equipped with filtration media, the bottom of the media unit should be installed above the level of normal stormwater flow to avoid submerging the media and creating anoxic conditions within the unit. If the media is above the crown of the outlet pipe, it is assumed to be above the normal level of flow.²

8.16.6 Maintenance and Inspections

Routine maintenance activity is necessary to ensure the effectiveness of CBIs. The most typical cause of CBI malfunction is clogging due to excessive loading of sediment or vegetative matter. CBI clogging can lead to loss of incoming sediment, release of captured pollutants due to flushing, or creation of mosquito and other vector habitats due to pooling.

As CBI design varies greatly across manufacturers, newly-installed systems should be inspected after experiencing two to three heavy storm events in order to assess functionality and ensuing maintenance frequency.

Typical maintenance activities include:

- Frequent inspection of CBI units. When several units are installed at a given site, it should be noted that the maintenance cycle for each unit may vary.
- Remove accumulated trash and debris as needed.
- Maintain good housekeeping practices with landscaping and vegetation such as bagging fallen leaves and sweeping up grass clippings and bud shatter to avoid excess loading to the CBI.
- Inspect CBI during rainfall events to assess applicability of the specific unit to site stormwater flows. Observation of frequent bypass may indicate a misapplication.

- Replace CBIs when sediment loading causes clogging of the system. For CBIs intended to absorb oil, inspect treated water for sheen or other signs that the unit's absorption capacity has been exceeded.
- Follow any additional maintenance recommendations given by the manufacturer.

8.16.7 Design Example

Design of catch basin inserts must be completed by the manufacturer.

8.17 BAFFLE BOXES & OIL/GRIT SEPARATORS



Picture Source: ADS/Hancor Inc.Inc.

Targeted Constituents

Sediment	●
Nutrients	○
Trash	●
Metals	○
Bacteria	○
Oil and Grease	●
Organics	○

Legend (Removal Effectiveness)

High	Medium	Low
●	●	○

8.17.1 Description

Baffle Boxes, also known as Oil/Grit Separators describe a wide variety of proprietary devices that have been developed in recent years. They are modifications of traditional oil/particle separators that typically target coarse solids and large oil droplets. These systems utilize proven technology of particle separation using Stoke's Law principles, and a standard orifice equation. Most of these systems are installed in an offline configuration, treating the "first flush" from a storm event by utilizing a bypass structure to divert the first flush into the treatment unit.

8.17.2 General Application

Baffle Boxes and Oil/Grit separators are typically used for water quality enhancement in urban and ultra-urban areas where surface BMPs are not feasible. They are also commonly used as pre-treatment for surface BMP's where a treatment train is necessary to accomplish water quality goals. Most are flow-through structures in that the design rate of flow into the structure is regulated by the bypass structure as opposed to BMPs designed to store the entire water quality volume.

These systems typically have a sediment chamber that is sized based on Stoke's Law principles, and a chamber for floatables and hydrocarbon trapping. Normally, these systems operate on the principles of "first flush" treatment which provides the ability for larger storms to flow around the unit without re-suspending particles, which have already been trapped. This provides for retention of the particles even during very large storms, without the fear of re-suspension. Oil, grease, and floatable trash and debris collect at the surface of the separator. The floating material is prevented from leaving the unit by a system of baffles and weirs.

Most baffle boxes and Oil/Grit separators utilize a bypass structure or other flow control structure to direct the "first flush" into the treatment unit. Flows that exceed the treatment capacity of the unit are bypassed in the existing storm sewer.

8.17.3 Advantages

- This new generation of Baffle Boxes and Oil/Grit Separators provide effective removal of particles as small as 100 microns in less space and at less cost than traditional wet or dry basins.
- These systems also provide effective removal of Hydrocarbons and floatables in storm sewer effluent.
- Shallow installation depths allow for ease of installation. They are installed parallel to existing storm sewers, which makes baffle boxes and oil/grit separators particularly suitable in retrofit applications, particularly in highly developed areas.
- Maintenance costs and requirements are typically less than with traditional settling basins.
- When used as pretreatment in treatment train applications, these systems can prolong the maintenance interval of downstream systems.

8.17.4 Disadvantages

- Dissolved pollutants are not treated by these systems.
- Regular maintenance is required to assure proper operation of the system.
- Systems that have standing pools of water between storms may cause some level of concern about mosquito breeding.³
- These systems do not effectively remove fine particles (on the order of 50 microns in diameter and less).

8.17.5 Siting and Design Considerations

Design and subsequent performance expectations differ from manufacturer to manufacturer, but the following design considerations hold for most baffle boxes and oil/grit separators that are currently available:

- Since these systems operate in a bypass configuration, care should be taken to make sure that proper fall in the bypass line exists in order to be able to tie the treated line back into the main line. Failure to take this into consideration, or to request a weir at the bypass, will result in improper hydraulics, and difficult field adjustments.
- Depending on the size of the unit specified, they can have a relatively large horizontal footprint. Care should be taken to make sure adequate room is provided to allow for proper installation.
- Headloss differs with the product and the model but is generally on the order of one foot or less.
- Like all proprietary BMPs, the design of these systems is specific to the manufacturer. As such, approval should be subject to performance verification. Third party performance testing should be requested by design engineer.
- When treatment goals are measured in terms of TSS removal, a target particle size should be identified to assist in separator sizing. Most manufacturers base their performance claims on laboratory testing with sediment of a specified particle size distribution.

8.17.6 Maintenance

- Maintenance of Baffle Boxes & Oil Grit Separators consists of the removal of trapped material with a vacuum truck. As such, these systems should be installed in locations accessible to such equipment.
- Typical maintenance interval is one year; however, site-specific experience may indicate the need for more or less frequent maintenance.
- Design plans for these systems should include inspection and maintenance requirements and schedules.

8.17.7 Design Example

Design specifications for Baffle Box depend on the particular device and must be completed by the manufacturer.

8.18 VEGETATED FILTER STRIP

8.18.1 Description

Vegetated filter strips are uniformly graded and densely vegetated sections of land, engineered and designed to treat runoff and remove pollutants through vegetative filtering and infiltration. Filter strips are best suited to treating runoff from roads, roof downspouts, small parking lots, and pervious surfaces. They are also ideal components of the "outer zone" of a stream corridor (outer 1/3rd), or as pretreatment for another structural stormwater control. Filter strips rely on the use of vegetation to slow runoff velocities and filter out sediment and other pollutants from urban stormwater. To be effective, sheet flow must be maintained across the entire filter strip.

8.18.2 Design Requirements and Considerations

Vegetated filter strips shall be designed to meet the following requirements:

8.18.2.1 Entrance Flow

Flow must enter and exit the filter strip as sheet flow spread out over the width (long dimension perpendicular to flow) of the strip. For runoff from impervious areas, flow spreaders such as concrete sills, curb stops, curb cuts, or pea gravel diaphragms (gravel-filled trench) shall be incorporated along the upstream length of the VFS.

8.18.2.2 Sizing

The filter strip length shall be properly sized in order to provide adequate filtration and contact time for water quality treatment. The following requirements shall apply to the design of vegetated filter strips (see **Figure 8.27**):

- Maximum effective inflow approach length (area tributary to VFS) shall be 130 feet. Effective inflow length (L_a) shall be calculated as follows:

$$L_a = P_L + 2 * I_L$$

Where:

P_L = pervious area flow length

I_L = impervious area flow length

- VFS length (measured in the direction of flow through VFS) shall be equal to one third (1/3) of the effective inflow approach length (L_a) with a minimum of ten (10) feet.

8.18.2.3 Grades

Ground slope across the VFS shall be greater than 1% and less than 6%, measured in the direction of flow. The areas at the entrance and exits of the vegetated filter strips should be graded to provide a smooth transition for flow entering and discharging from the filter strip.

8.18.2.4 Vegetation

Filter strips should not be used on soils that cannot sustain a dense grass cover with high retardance. Grasses in filter strips must be able to withstand relatively high velocity flows at the entrances, and both wet and dry periods. For constructed or enhanced filter strips, designers should reference MARC/APWA BMP Manual Section 7.3 and plant species lists provided in Chapter 8 for a list of acceptable grasses for use in this region. In addition, non-invasive species listed in "Flora of the Great Plains" (Barkley, 1986) may be utilized. For existing vegetated areas to function as a filter strip as part of the Stormwater Management Plan, the area must contain dense grassy (non-

wooded) vegetation with a minimum height of 12" providing complete coverage (no areas of open bare soil) and be able to withstand relatively high flow velocities. Turf grass is not an approved filter strip. Grass and filter strip areas shall be protected from frequent mowing in accordance with section D.3.

8.18.3 Value Rating

Inflow areas treated by a vegetated filter strip as described above shall be assigned a Value Rating of 5.0. A Value Rating of 9.25 for "native vegetation" shall be applied to the area of the vegetated filter strip. Note vegetated filter strips are excellent pretreatment BMPs and designers should utilize the treatment train calculation provided in Chapter 4 of the MARC/APWA BMP Manual using filter strips as the first BMP in sequence prior to swales, bioretention, detention practices, and wetlands.

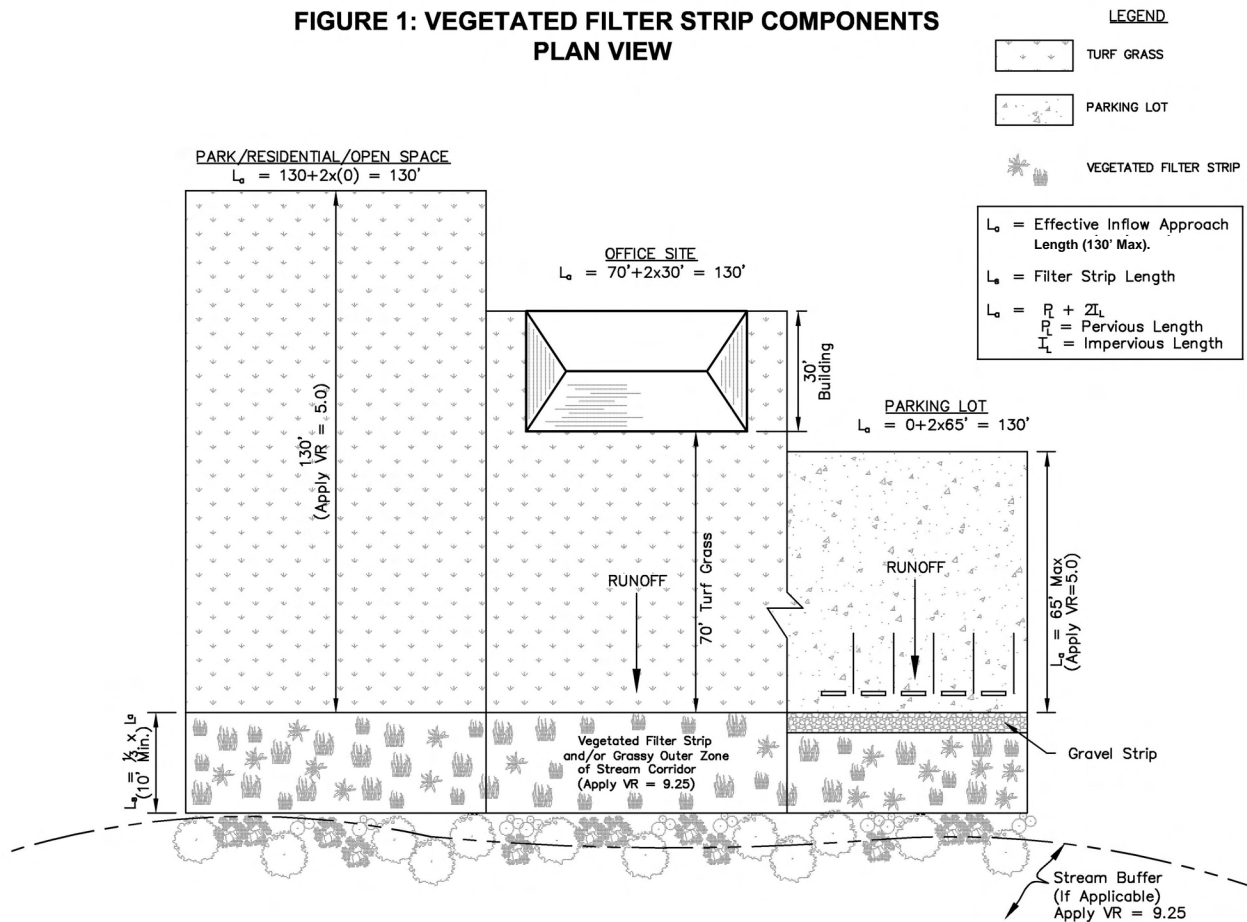

Figure 8.27 - Vegetative Filter Strip

Section 9

Links to Other Program Requirements

9.0 LINKS TO OTHER PROGRAM REQUIREMENTS

This manual complements and complies with local stormwater management programs and guidelines. The ensuing sections provide additional guidance for applying construction practices and controlling sediment and erosion to protect water quality. The following information is not a substitute for reviewing and implementing APWA Section 5100, but a complement to it.

9.1 PHASED CONSTRUCTION

Perform development of sites in phases. Phasing should include construction operation timelines and timelines for land disturbance and stabilization that minimize degradation of surrounding water bodies. Effective phased construction minimizes disturbed areas during the stages of a development. Consider phased construction as a BMP to include in the proper package of BMPs discussed in Section II.

In phased construction, soil is disturbed as little as possible during all construction phases to minimize erosion and prevent sediment from migrating off site. It is also imperative to limit the time of subsurface-soil exposure. For example, disturb only the part of the site applicable to immediate work. Stabilize that portion of the project before continuing to the next phase. Detail construction phasing in the erosion and sediment control plan.

More preferably on large sites, develop the tract of land in sections. For example, leave bottomland and watercourses undisturbed until uplands have been developed and stabilized. This provides a natural buffer for stormwater to slow and filter stormwater runoff from the site. After stabilizing uplands, continue development on lower lying lands. This type of phasing generates the greatest number of credits. On tracts of land over 80 acres, disturb only one-quarter of the site at a time until other sections have been stabilized.

9.2 SEDIMENT AND EROSION CONTROL PLANS

An erosion and sediment control plan defines and schedules control measures to minimize erosion and prevent sediment-laden stormwater from leaving the project site. Erosion and Sediment plans are required by the NPDES permitting program for construction activities. The Kansas Department of Health and Environment (KDHE), Bureau of Water, Industrial Programs Section administers the program referred to as a Stormwater Pollution Prevention Plan (SWPPP). The Missouri Department of Natural Resources (MDNR), Water Protection and Soil Conservation Division administers the program in Missouri. Each state's process is described briefly below.

In Kansas, owners or operators of any project that will disturb one or more acres must apply for authorization. Apply for the permit by completing a Notice of Intent (NOI) form at least 60 days before start of construction. A qualified professional must seal the SWPPP. The plan should include the location, installation, and maintenance of the practices foreseen to minimize erosion and prevent sediment from leaving the site.

Begin the permitting process by filing a NOI and paying a filing fee of \$60 to KDHE 60 days before starting construction. Submit the SWPPP, sealed by a qualified stormwater professional. The contractor is also responsible for submitting a contractor certification form. After the project is stabilized, submit a notice of termination.

In Missouri, contact the Corps to determine if the project is in jurisdictional waters and is regulated. A project may be regulated if it involves placing materials in a lake, river, stream, or wetland (including dry streams or wetlands). If the project is regulated, complete a 401 Certification Application Checklist. If also applying to the Corps for a 404 permit, attach the 404 permit application form (ENG Form 4345) and provide any additional information needed (and a mitigation plan when impacting a jurisdictional stream and/or wetland). Note that a 401 Certification Application is required even if the project is authorized under a nationwide permit. MDNR has a list of general conditions for certain nationwide permits. Submit the application to MDNR. The 401 Certification Application fee is \$75. Upon receipt of the fee, a copy of the certification will be mailed to the appropriate office of the Corps of Engineers to inform them the certification is now in effect and final.

More information and forms required for permitting are on KDHE's web site at URL www.kdhe.state.ks.us/stormwater and MDNR's web site at URL <http://www.dnr.state.mo.us/wpscd/wpcp/homewpcp.htm>.

Refer to APWA 5100 for detailed guidance on preparing sediment and erosion control plans.

Section 10

References

10.0 REFERENCES

- APWA BMP Subcommittee, SP-1. Bioretention Facility.
- Atchison, D., K. Potter, and L. Severson. 2006. Design Guide for Stormwater Bioretention Facilities. Publication No. WIS-WRI-06-01. University of Wisconsin Dept. of Engineering. February.
- Atlanta Regional Commission. 2001. *Georgia Stormwater Management Manual Volume 2 (Technical Handbook)*.
- Bioretention for Infiltration. 2006. *Conservation Practice Standard 1004*. Wisconsin Department of Natural Resources. July.
- Brater, E.F. and H.W. King. 1976. *Handbook of Hydraulics: for the Solution of Hydraulic Engineering Problems*. 6th Ed.
- California Stormwater Quality Association. 2003. *California Stormwater Quality Association Stormwater Best Management Practice Handbook*.
- California Stormwater Quality Task Force. 1993. *California Stormwater Best Management Practice Handbook*.
- Camp Dresser & McKee Inc. 2001. *Big Creek Water Reclamation Facility Service Area Water Resources Management Plan*.
- 2005. *Florida TMDL Protocol*.
- 2005. *City of Lincoln, Nebraska; Stevens Creek Watershed Master Plan*. March.
- 1989. *Daytona Beach Stormwater Master Plan*.
- Center for Watershed Protection (CWP). 2000a. National Pollutant Removal Performance Database for Stormwater Treatment Practices, 2nd Edition. June.
- CWP. 2000b. Managing Watersheds for Quality Development. March.
- Chesapeake Bay Foundation. 1996. Dollars and Sense Partnership: Economic Development and Environmental Protection.
- Choi, Jin-Yong and Engel, Bernard A. No Date. *Urban BMPs and Cost Estimation*. Purdue University. On-Line Address: <http://pasture.ecn.purdue.edu/~jychoi/ubmp0/home0.htm>
- City of Knoxville. 2001. *BMP Manual*.
- City of Lenexa, Kansas. 2001. *Stream Asset Inventory*. June 19.
- City of Portland, Oregon. 2002. *Stormwater Management Manual, Revision #2*. Environmental Services Department. September.
- City of Topeka, Kansas. 2001. *Permanent Treatment Practices; BMP Manual*.
- Claytor, Richard A. and Thomas R. Schueler. 1996. *Design of Stormwater Filtering Systems*. Center for Watershed Protection. December.
- Connecticut Department of Environmental Protection. 2004. *2004 Connecticut Stormwater Quality Manual*. 11-S10.
- Federal Highway Administration, *Stormwater Best Management Practices in an Ultra-Urban Setting: Selection and Monitoring*. Available online: <http://www.fhwa.dot.gov/environment/ultraurb/index.htm>
- Florida Department of Environmental Protection. 2006. *TMDL Protocol Version 6.0*.
- Florida Department of Environmental Regulation. 1988. *The Florida Development Manual*.

-
- Haag, Dennis, Andrew Mazzeo, and Scott Schulte. 2001. *Innovative Technologies for Treatment of Stormwater and Municipal Wastewater*. Presented to the 51st Annual Environmental Engineering Conference, University of Kansas, Lawrence, Kansas. January.
- Idaho Department of Environmental Quality. 2000. *Catalog of Stormwater BMPs for Cities and Counties*.
- Johnson County, Kansas. 2001. *Stream Protection Guidelines for Johnson County*. Prepared for U.S. Environmental Protection Agency, Region 7. July.
- Kansas City Metropolitan Chapter of the American Public Works Administration. 2006. *Division V Section 5600 Storm Drainage Systems and Facilities*.
- Kansas State Board of Agriculture, Division of Water Resources. 1986. *Engineering Guide – 1 (DWR 2-504)*.
-----, Division of Water Resources 1986. *Engineering Guide – 2 (DWR 2-505)*.
- King County Surface Water Management Division, King County Department of Metropolitan Services, Snohomish County Surface Water Management Division, Seattle Drainage and Wastewater Utility, and Port of Seattle. 1995. *Evaluation of Commercially-Available Catch Basin Inserts for the Treatment of Stormwater Runoff from Developed Sites*.
- Malcom, H.R., Ph.D. 1997. *Introduction to Hydrology Course Notes*. North Carolina State University.
- Mays, Larry W. 1996. *Water Resources Handbook*.
- Metropolitan Council. 2001. *Minnesota Urban Small Sites BMP Manual*. July.
- Metropolitan Nashville – Davidson County. 2000. *Stormwater Management Manual Volume 4: Best Management Practices*.
- Mid-America Regional Council and American Public Works Association. 2003. *Manual of Best Management Practices for Stormwater Quality*.
- Minton, G.R. 2005. *Stormwater Treatment*, 2nd Edition. Resource Planning Associates, Seattle, WA. Ch.7, p.122.
- Natural Resource Conservation Service. 1997. *Engineering Field Handbook*.
- Natural Resources Conservation Service – Maryland. 2000. Code No. 378 Pond Standards/Specifications.
- Naval Facilities Engineering Service Center. 2004. *Joint Service Pollution Prevention Opportunity Handbook; Wet Detention Ponds to Treat Stormwater Runoff*.
- Office of Water, United States Environmental Protection Agency. 1999. *Stormwater Technology Fact Sheet*.
- Patti Banks Associates. Draft. *Kansas City Stream Asset Inventory Phase I*. Prepared for the City of Kansas City, Missouri City Planning and Development Department.
- Prince George's County, Maryland. 1999. *Low-Impact Development Design Strategies – An Integrated Approach*. Department of Environmental Resources, Programs and Planning Division. June.
- Programs & Planning Division, Department of Environmental Resources, Prince George's County, MD. Revised 2002. *The Bioretention Manual*.
- Texas Chapter of American Public Works Association. 1998. *Texas Nonpoint Source Book*. On-Line Address: www.epa.gov/ord/webpubs/nctvw/promise.pdf.
- Urban Drainage and Flood Control District, Denver, Colorado. 1999. *Urban Storm Drainage Criteria Manual Vol. 3 – Best Management Practices*. September.
- Urban Drainage and Flood Control District. 2005. *Urban Storm Drainage Criteria Manual – Volume 3: Best Management Practices*. Denver, Colorado.

-
- U.S. Department of Agriculture (USDA). 1999. Kansas Field Office Technical Guide. Natural Resources Conservation Service. July.
- U.S. Department of Agriculture (USDA). 1997. National Engineering Handbook, Part 650 – Engineering Field Handbook, 210-VI-Amendment KS1. Natural Resources Conservation Service. June 25.
- USDA. 1986. Urban Hydrology for Small Watersheds, Technical Release 55. Natural Resources Conservation Service. June.
- . 1984. Engineering Field Manual Chapter 11,- Ponds and Reservoirs. Natural Resources Conservation Service.
- . 1972. National Engineering Handbook, Part 630 – Hydrology. Natural Resources Conservation Service.
- . 1966. Handbook of Channel Design for Soil and Water Conservation. Natural Resources Conservation Service.
- US EPA. 1993a. Guidance Specifying Management Measures for Sources of Nonpoint Pollution in Coastal Waters. EPA 840-B-92-002. Washington, DC.
- U. S. Environmental Protection Agency. 1986. Methodology for Analysis of Detention Basins for Control of Urban Runoff Quality.
- U. S. Department of Interior. 1963. Hydraulic Design of Stilling Basins and Energy Dissipaters. Bureau of Reclamation. July.
- U. S. Department of Transportation. 1983. Hydraulic Engineering Circular No. 14 – Hydraulic Design of Energy Dissipaters for Culverts and Channels. Federal Highway Administration. September.
- Virginia Department of Conservation and Recreation. 1999. Virginia Stormwater Management Handbook. Ch.3.
- Wyoming Department of Environmental Quality. 1999. Urban Best Management Practices for Nonpoint Source Pollution. Water Quality Division. February.
- Young, Bryan C. and McEnroe Bruce M. 2002. Precipitation Frequency Estimates for the Kansas City Metropolitan Area. University of Kansas. June.

Appendix A

Example Specifications

APPENDIX A
EXAMPLE CONSTRUCTION AND MATERIAL SPECIFICATIONS
SECTION 9000 BEST MANAGEMENT PRACTICES

KANSAS CITY METROPOLITAN CHAPTER
OF THE AMERICAN PUBLIC WORKS ASSOCIATION

TABLE OF CONTENTS

SECTION 2301 NATIVE SOIL AND VEGETATION PRESERVATION	2
2301.1 Construction Requirements.....	2
2301.2 Construction Specifications.....	2
2301.3 Inspection and Maintenance	2
SECTION 2302 NATIVE SOIL RESTORATION.....	3
2302.1 Materials.....	3
2302.2 Topsoil.....	3
2302.3 Removal	3
2302.4 Substitutes and Supplements	3
2302.5 Storage.....	3
2302.6 Vegetation.....	4
SECTION 2303 BIORETENTION FACILITIES.....	4
2303.1 Description	4
2303.2 Materials.....	4
2303.3 Construction	7
2303.4 Method of Measurement	8
2303.5 Basis of Payment	8
SECTION 2304 PLANTING & MANAGING NATURAL VEGETATION FOR BMPs	9
2304.1 Summary.....	9
2304.2 Materials.....	10
2304.3 Selective Woody Brush Removal.....	20
2304.4 Herbaceous Species Removal.....	21
2304.5 Soil Preparation.....	23
2304.6 Cover Crop Seeding.....	24
2304.7 Herbaceous Perennial Planting.....	25
2304.8 Seeding.....	26
2304.9 Tree and Shrub Planting	27
2304.10 Management	28
2304.11 Odds & Ends.....	29

APPENDIX A
EXAMPLE CONSTRUCTION AND MATERIAL SPECIFICATIONS
SECTION 9000 BEST MANAGEMENT PRACTICES

SECTION 9001 NATIVE SOIL AND VEGETATION PRESERVATION

9001.1 Construction Requirements

- A. **Selective clearing** is removal of undesirable trees and underbrush around specimen trees and brush as designated on the drawings and/or instructed by the Engineer.
- B. Soil and specimen trees as shown on the drawings and/or instructed by the Engineer to save, shall be protected from damage incident to clearing, grubbing, and construction operations, by the erection of timber barriers or by such other means as the circumstances require. Such barriers must be placed and be approved by the Engineer before construction operations can proceed.
- C. **Plant Preservation:** All plant materials on the site to be saved and/or relocated shall be marked specifically by the Engineer. No plant material may be removed from the site prior to the Engineer's inspection. All plant material to be saved/or relocated will be protected from injury to the roots and to the branches, to a distance five feet beyond the drip-line. No grading, trenching, pruning, or storage of materials may go in this area, except as approved by the Engineer.
- D. **Trees and Plants to be Relocated:** Any tree or plants moved shall be done in a timely manner so as not to delay construction progress. The Contractor shall take extra measures to protect the tree during the relocation by erecting barricades, staking, trimming, etc. as required. All trees to be relocated shall be performed by certified arborists. Tree relocation shall be performed between October 15th, and April 15th. Tree relocation shall be measured per each tree relocated, in place and accepted.

9001.2 Construction Specifications

- A. Silt, snow, board, plastic fence, or other approved methods of restricting access shall be installed 5 feet outside of the drip line of trees and plant materials marked to be preserved.
- B. No construction activity is allowed inside these barriers.
- C. Avoid movement and parking of vehicles over the root zones where no grading is proposed.
- D. Do not store materials in restricted access areas within the drip line of trees and plant materials marked to be preserved.
- E. Avoid placing fill within the drip line of trees marked to be saved.
- F. Where necessary, up to 20 percent of the area within the drip line of trees to be preserved may be disturbed when approved by the Engineer. Tree roots within the limits of disturbance shall be cleanly severed using a chainsaw or other approved mechanical method.

9001.3 Inspection and Maintenance

- A. The Contractor and Engineer shall inspect trees for damage, stress and disease, and will bring any occurrences to the attention of the Engineer.
- B. The Engineer will mark trees that require repairs.
- C. Repairs, to include pruning, applying wound dressings, etc., shall be made by the Contractor within 7 days of occurrence.

- D. The Contractor shall replace trees that have been damaged beyond saving after construction is complete at no additional cost to the Owner.
- E. Remove the protective measures when construction is complete.

SECTION 9002 NATIVE SOIL RESTORATION

9002.1 Materials

Prior to delivery of any materials to the site, submit to the Engineer a complete list of all materials to be used during this portion of the work. Include complete data on source, amount and quality. This submittal shall in no way be construed as permitting substitution for specific items described on the plans or in these specifications unless approved in writing by the Engineer.

9002.2 Topsoil

The full depth of topsoil shall be stripped from all grading areas, using a phased approach where appropriate. Topsoil up to a minimum depth of six (6) inches or the entire A horizon of the applicable soil series being disturbed as published in the Published County Soil Survey or other detailed soil survey, shall be stripped and stockpiled from all areas to be excavated or filled.

9002.3 Removal

- A. All "A horizon" and topsoil shall be removed and segregated as a separate layer from the area to be disturbed. Where the Engineer determines that the topsoil is of insufficient quantity or poor quality for sustaining vegetation, other materials may be substituted with approval by the Engineer in accordance with paragraph *Substitutions and Supplements* of this section. Selected overburden materials to be substituted shall be removed as a separate layer from the area to be disturbed, and segregated.
- B. If topsoil is less than 6 inches thick, the operator may remove the topsoil and the unconsolidated materials immediately below the topsoil to a total depth of 6 inches and treat the mixture as topsoil.
- C. Timing: All material to be removed under this section shall be removed after the vegetative cover that would interfere with its salvage is cleared from the area to be disturbed, but before any drilling, blasting, excavating, or other surface disturbance takes place.

9002.4 Substitutes and Supplements

Selected overburden materials may be substituted for, or used as a supplement to topsoil pursuant to a detailed soil survey and restoration plan that demonstrates to the Engineer that the resulting soil medium is equal to, or more suitable for sustaining vegetation than, the existing topsoil, and the resulting soil medium is the best available in the area where native soil is to be disturbed and restored. Topsoil substitutes and supplements shall consist of approximately thirty percent (30%) clay, thirty-five percent (35%) silt, thirty percent (30%) sand and five percent (5%) organic matter. Organic matter shall be Dakota Peat, biosolids, composted biomass, or other materials that are approved by the Engineer. All mixing of materials must be by a soil-blending machine and may be done either on- or off-site. The Engineer must approve the end product. After the topsoil mixture has been thoroughly blended, it shall be transported to the area of spreading and dumped at various points within the area. The material can then be moved more easily by a small crawler-type tractor suitably equipped with a blade to push the mixture onto the prepared surface. After the mixture has been spread uniformly over the surface, it must be firmed into place by light compaction with the crawler tractor. Any soft spots existing after the firming process, must be raked, floated and lightly compacted to obtain a uniform depth of placement.

9002.5 Storage

- A. Materials removed shall be segregated and stockpiled when it is impractical to redistribute such materials promptly on re-graded areas.

- B. Stockpiled materials shall meet the following requirements:
1. Be selectively placed on a stable site within the construction area;
 2. Be protected from contaminants and unnecessary compaction that would interfere with revegetation;
 3. Be protected from wind and water erosion through prompt establishment and maintenance of an effective, quick growing vegetative cover or through other measures provided in the approved water pollution control plan; and
 4. Not be moved until required for redistribution unless approved by the Engineer.
- C. Where long-term stockpiling of materials is required, and where such stockpiling would be detrimental to the quality or quantity of those materials, the Engineer may approve the temporary distribution of the soil materials to an approved site within the construction area.
1. Such action will not permanently diminish the capability of the topsoil of the host site.
 2. The material will be distributed in a condition more suitable for redistribution than if stockpiled.
- D. Redistribution
1. Topsoil materials removed shall be redistributed in a manner that--
 - a. Achieves an approximately uniform, stable thickness consistent with the approved restoration plan, finished grading, and surface-water drainage systems;
 - b. Prevents excess compaction of the materials; and
 - c. Protects the materials from wind and water erosion before and after seeding and planting.
 2. Before redistribution of the material removed, the regraded land shall be scarified to reduce potential slippage of the redistributed material and to promote root penetration. Such treatment may be conducted after the material is replaced if no harm will be caused to the redistributed material and reestablished vegetation.
 3. The Engineer may choose not to require the redistribution of topsoil or topsoil substitutes on the final embankments if it determines that--
 - a. Placement of topsoil or topsoil substitutes on such embankments will result in greater sedimentation than would otherwise occur, or
 - b. Such embankments will be stabilized by other approved means.

9002.6 Vegetation

Vegetation shall be established on all exposed surfaces. Plantings shall be as shown in the plans and as specified.

SECTION 9003 BIORETENTION FACILITIES

9003.1 Description

Bioretention facilities are small landscaped basins intended to provide water quality management by filtering stormwater runoff before release into storm drain systems. This work shall consist of installing bioretention facilities as specified in the Contract Documents, including all materials, equipment, labor and services required to perform the work.

9003.2 Materials

- A. **Bioretention Soil Mixture:** The Bioretention Soil Mixture (BSM) is a mixture of planting soil, mulch, and sand consisting of the following:

Item	Composition By Volume	Reference
Planting Soil	30%	See below.
Organic Compost	20%	See below.
Sand	50%	ASTM C33 Fine Aggregate

- B. **Planting Soil:** The USDA textural classification of the Planting Soil for the BSM shall be LOAMY SAND OR SANDY LOAM. The Planting Soil shall be the best available on site material or furnished. Additionally, the Planting Soil shall be tested and meet the following criteria or as approved by the Engineer:

Item	Percent By Weight	Test Method
Sand (2.0 – 0.050 mm)	50 – 85%	AASHTO T88
Silt (0.050 – 0.002 mm)	0 – 50%	AASHTO T88
Clay (less than 0.002 mm)	2 – 5%	AASHTO T88
Organic Matter	3 – 10%	AASHTO T194

The textural analysis for the Planting Soil shall be as follows:

ASTM E11 Sieve Size	Minimum Percent Passing By Weight
2 in.	100
No. 4	90
No. 10	80

At least 45 days prior to the start of construction of bioretention facilities, the Contractor shall submit the source and testing results of the Planting Soil for the BSM to the Engineer for approval. No time extensions will be granted should the proposed Planting Soil fail to meet the minimum requirements stated above. Once a stockpile of the Planting Soil has been sampled, no material shall be added to the stockpile.

- C. **Organic Compost:** Compost is a homogeneous and friable mixture of partially decomposed organic matter, with or without soil, resulting from composting, which is a managed process of bio-oxidation of a solid heterogeneous organic substrate including a thermophilic phase.

Compost is deemed acceptable if it meets 2 of the following requirements:

1. C/N ratio \leq 25;
2. Oxygen uptake rate \leq 150 mg O₂/kg volatile solids per hour; and
3. Compost must not contain more than 1 percent foreign matter. Foreign matter is defined as: "Any matter over a 2 mm dimension that results from human intervention and having organic or inorganic constituents such as metal, glass and synthetic polymers (e.g. plastic and rubber) that may be present in the compost but excluding mineral soils, woody material and rocks."
4. Foreign matter less than 1 percent by weight must not exceed 12.5 mm in any dimension.

- D. **The Bioretention Soil Mixture (BSM)** shall be a uniform mix, free of plant residue, stones, stumps, roots or other similar objects larger than two inches excluding mulch. No other materials or substances shall be mixed or dumped within the bioretention area that may be harmful to plant growth, or prove a hindrance to the planting or maintenance operations.

1. The Bioretention Soil Mixture shall be tested and meet the following criteria:

Item	Criteria	Test Method
Corrected pH	5.5 – 7.5	ASTM D4972
Magnesium	Minimum 32 ppm	*
Phosphorus (Phosphate - P ₂ O ₅)	not to exceed 60 ppm plant available phosphorus	*
Potassium (K ₂ O)	Minimum 78 ppm	*
Soluble Salts	Not to exceed 500 ppm	*

* Use authorized soil test procedures.

2. Should the pH fall outside of the acceptable range, it may be modified with lime (to raise) or ammonium sulfate (to lower). The lime or ammonium sulfate must be mixed uniformly into the BSM prior to use in bioretention facilities.
3. Should the BSM not meet the minimum requirement for magnesium, it may be modified with magnesium sulfate. Likewise, should the BSM not meet the minimum requirement for potassium, it may be modified with potash. Magnesium sulfate and potash must be mixed uniformly into the BSM prior to use in bioretention facilities.
4. Planting soil and/or BSM that fails to meet the minimum requirements shall be replaced at the Contractor's expense. Mixing of the corrective additives to the BSM is incidental and shall be at the Contractor's expense.
5. Mixing of the BSM to a homogeneous consistency shall be done to the satisfaction of the Engineer. Upon approval of all requirements and testing above, the BSM shall be stockpiled, and no material shall be added to the BSM in the stockpile or during transport to the bioretention facility.

E. Other Materials

Material	Specification
No. 57 Aggregate	ASTM D448
No. 7 Aggregate	ASTM D448
4-inch HDPE Plastic Pipe Underdrain	AASHTO M252
Geotextile Fabric	AASHTO M288
Mulch, 2x Shredded Hardwood Bark	See below
Water	See below.
Lime	ASTM C25
Ammonium Sulfate	See below.
Magnesium Sulfate	See below.
Potash	See below.

1. **Shredded Hardwood Mulch:** Shredded hardwood mulch shall be aged a minimum of 6 months and consist of the bark and wood (50/50) from hardwood trees which has been milled and screened to a maximum 4 in. particle size and provide a uniform texture free from sawdust, clay, soil, foreign materials, and any artificially introduced chemical compounds that would be detrimental to plant or animal life.

2. **Aggregate:** No. 7 and No. 57 Aggregate shall be double-washed to reduce suspended solids and potential for clogging. The aggregate shall be placed as shown in the Contract Drawings.
3. **Water:** Water used in the planting, establishing, or caring for vegetation shall be free from any substance that is injurious to plant life.
4. **Lime:** Lime shall contain not less than 85 percent calcium and magnesium carbonates. Dolomitic (magnesium) lime shall contain at least 10 percent magnesium as magnesium oxide and 85 percent calcium and magnesium carbonates. Lime shall conform to the following gradation:

Sieve Size	Minimum Percent Passing By Weight
No. 10	100
No. 20	98
No. 100	50

5. **Ammonium Sulfate:** Ammonium sulfate shall be a constituent of an approved horticultural product produced as a fertilizer for supplying nitrogen and as a soil acidifier.
6. **Magnesium Sulfate:** Magnesium sulfate shall be a constituent of an approved horticultural product produced as a fertilizer.
7. **Potash:** Potash (potassium oxide) shall be a constituent of an approved horticultural product produced as a fertilizer.

9003.3 Construction

Bioretention facilities shall not be constructed until all contributing drainage areas are permanently stabilized against erosion and sedimentation as shown on the Contract Plans and to the satisfaction of the Engineer. Any discharge of sediment that affects the performance of the cell will require reconstruction of the cell to restore its defined performance. No heavy equipment shall operate within the perimeter of a bioretention facility during underdrain placement, backfilling, planting, or mulching of the facility.

- A. **Excavation:** If the bioretention facility is to be used as a sediment basin the bioretention facility shall be excavated to the dimensions, side slopes, and **1 foot above** the bottom of the Bioretention Soil Mixture elevations shown on the Contract Plans. Any sediment from construction operations deposited in the bioretention facility shall be completely removed from the facility after all vegetation, including landscaping within the drainage area of the bioretention facility, has been established. The excavation limits shall then be final graded to the dimensions, side slopes, and **final** elevations shown on the Contract Plans. Excavators and backhoes, operating on the ground adjacent to the bioretention facility, shall be used to excavate the facility if possible. low ground-contact pressure equipment or, if approved by the engineer, by excavators and/or backhoes operating on the ground adjacent to the bioretention facility. Low ground-contact pressure equipment is preferred on bioretention facilities to minimize disturbance to established areas around perimeter of cell. No heavy equipment shall be used within the perimeter of the bioretention facility before, during, or after the placement of the BSM.

Excavated materials shall be removed from the bioretention facility site. Excavated materials shall be used or disposed of in conformance with the project specifications.

- B. **Roto-tilling:** After placing the underdrain and aggregate and before the BSM, the bottom of the excavation shall be roto-tilled to a minimum depth of 6 inches to alleviate any compaction of the facility bottom. Any substitute method for roto-tilling must be approved by the Engineer prior to use. Any ponded water shall be removed from the bottom of the facility and the soil shall be friable before roto-tilling. The roto-tilling shall not be done where the soil supports the aggregate bed underneath the "Underdrain for Bioretention". (See "Underdrain for Bioretention" specifications below.)

- C. **Underdrain for bioretention:** The underdrain system, aggregate bed, and geotextile fabric shall be placed according to dimensions shown on the Contract Plans.
- D. **Observation wells/cleanouts** of 4-inch non-perforated HDPE pipe shall be placed vertically in the bioretention facility as shown on the Contract Plans. The wells/cleanouts shall be connected to the perforated underdrain with the appropriate manufactured connections as shown on the Contract Plans. The wells/cleanouts shall extend 6 inches above the top elevation of the bioretention facility mulch, and shall be capped with a screw cap.
- E. **Placement of the Bioretention Soil Mixture:** The Bioretention Soil Mixture (BSM) shall be placed and graded using low ground-contact pressure equipment or, if approved by the engineer, by excavators and/or backhoes operating on the ground adjacent to the bioretention facility. Low ground-contact pressure equipment is preferred on bioretention facilities to minimize disturbance to established areas around perimeter of cell. No heavy equipment shall be used within the perimeter of the bioretention facility before, during, or after the placement of the BSM. The BSM shall be placed in horizontal layers not to exceed 12 inches for the entire area of the bioretention facility. The BSM shall be saturated over the entire area of the bioretention facility after each lift of BSM is placed until water flows from the underdrain to lightly consolidate the BSM mixture. Water for saturation shall be applied by spraying or sprinkling in a manner to avoid separation of the BSM components. Saturation of each lift shall be performed in the presence of the Engineer. If the BSM becomes contaminated during the construction of the facility, the contaminated material shall be removed and replaced with uncontaminated material at the Contractor's expense. Final grading of the BSM shall be performed after a 24-hour settling period. Upon final grading the surface of the BSM shall be roto-tilled to a depth of 6". Final elevations shall be within 2 inches of elevations shown on the Contract Plans.
- F. **Mulching:** Once grading is complete, the entire bioretention facility shall be mulched to a uniform thickness of 3 inches. Mulching shall be complete within 24 hours to reduce the potential of silt accumulation on the surface. Well aged shredded hardwood bark mulch is the only acceptable mulch. Mulching shall be done immediately after grading to reduce potential of any silt accumulation on the surface.
- G. **Plant Installation:** Trees, shrubs, and other plant materials specified for Bioretention Facilities shall be planted as specified in the Contract Plans and applicable landscaping standards with the exception that pesticides, herbicides, and fertilizer shall not be applied during planting under any circumstances. Furthermore, pesticides, fertilizer, and any other soil amendments shall not be applied to the bioretention facility during landscape construction, plant establishment, or maintenance.

9003.4 Method of Measurement

Bioretention Facilities will be measured by the square foot and will be paid for at the Contract Unit Price.

9003.5 Basis of Payment

The payment will be full compensation for all material, labor, equipment, tools, and incidentals necessary to satisfactorily complete the work. Biological Plantings will be paid for separately under other items of the contract.

SECTION 9004 PLANTING & MANAGING NATURAL VEGETATION FOR BMPs

Purposefully designed planting plans are imperative for the successful incorporation of stormwater BMP's into the developed landscape, which must meet both functional goals and aesthetic expectations of public and private clientele.

Planting design for water quality BMP's is a purposeful design process which addresses many interrelated factors including regional and site specific factors of climate / microclimate, sunlight /shade and drought / inundation. The plant selection process requires careful consideration of numerous plant characteristics and horticultural requirements. In addition, site specific factors of scale, context, aspect, soil characteristics, associated recreational facilities, aesthetics and public expectations must be considered for each individual BMP.

Sensitive transitions to adjacent plantings and well delineated edges between differing land uses or vegetation types are integral components of any design.

The designer's approach to planting plan development is similar to the development of any other garden or planting bed plan. The most successful stream corridors and other water quality BMP's will be designed and used as multifaceted facilities. Ultimately these facilities, and the plant material contained within, not only address water quality issues but are integral to the creation of habitat for birds, animals, amphibians and aquatic life, while providing recreational areas for human beings. As such, BMP designs and plant selections, especially in urban and suburban areas, requires knowledge of attributes and characteristics which are beyond the scope of this document. In order to meet these multifaceted goals, the inclusion of a registered landscape architect or botanist/plant ecologist on the design team is strongly advised.

The native plant material provided in this manual (see Table 4 in this section) includes native species commonly found within a 50-mile or so radius of the KC metro area. Developing native plant list with such a narrow focus was intentional for the purpose of ensuring 'true' natives, specific to this area (i.e., local plant genotypes), are used. It is often assumed, albeit mistakenly, that any plant native to the United States will suffice for vegetating BMP's. However, natives from Pennsylvania, for example, are technically non-native and wouldn't respond to Midwestern environmental conditions as 'true' natives. A wide variety of 'true' native plant species, found in prairies, woods, and wetlands within the 50-mile radius, can be used successfully in the BMP's described in this manual. Consequently, this narrow approach will provide a solid starting point for BMP planting design in the KC metro area. Nevertheless, it is the prerogative of the landscape designer to choose other native or ornamental plants in the creation of a specific project palette, should the need arises as a result of context, preference, and site specific characteristics of a particular BMP.

9004.1 Summary

The work described herein consists of furnishing, transporting, and installing all trees, shrubs, roots, seeds, and other materials as required for the restoration and establishment of Mesic Forests, Savannas, Stream-side (riparian) Forests, Wet Prairies, Emergent Wetlands, Drainage Conveyance Swales, Ephemeral Wetlands, Mesic Prairies, and Dry Prairies and management of planting areas after final acceptance. The Contractor shall perform all planting, soil preparation, management, and such additional, extra and incidental work as may be necessary to complete the work in accordance with the specifications and plans. The Contractor shall furnish all required materials, equipment, tools, labor, and incidentals, unless otherwise provided in the specifications or plans.

- A. **Legal Responsibilities:** The Contractor shall at all times observe and comply with all Federal and State laws, local laws, ordinances, and regulations which in any manner affect the conduct of the work, and all such orders or enactments as exist at the present and which may be enacted later, of legislative bodies or tribunals having legal jurisdiction or which may have affect over the work.
- B. **Familiarity with Job Site:** The Contractor shall familiarize himself with conditions at the job site prior to the commencement of work. The Contractor shall notify the Engineer immediately if site conditions are such that inhibit progress of the work.

The Contractor shall be responsible for having all underground utilities located by servicing agency. The Contractor shall take all necessary precautions for the protection of utility facilities. The Contractor shall be responsible for any damage or destruction of utility facilities resulting from negligence or misconduct in the Contractor's manner or method of execution of the work, or caused by defective work or the use of unsatisfactory materials. Whenever any damage or destruction of a utility facility occurs as a result of work performed by the Contractor, the Utility company, Owner, and Engineer will be immediately notified.

C. Quality Assurance

1. **Qualifications of Workmen:** Provide at least one person who shall be present at all times during execution of this portion of the work, who shall be thoroughly familiar with this type of work and the type of materials being used. Said person shall be competent at identification of plant materials to be cut, preserved, and planted during the season (summer, winter) work is to be completed. Said person shall also direct all work performed under this section.
2. **Standards:** All materials used during this portion of the work shall meet or exceed applicable federal, state, county and local laws and regulations. The use of any herbicide shall follow directions given on the herbicide label. In the case of a discrepancy between these specifications and the herbicide label, the label shall prevail.

D. Submittals

1. **Materials:** Prior to delivery of any materials to the site, submit to the Engineer a complete list of all materials to be used during this portion of the work. Include complete data on source, amount, and quality. This submittal shall in no way be construed as permitting substitution for specific items described on the plans or in these specifications unless approved in writing by the Engineer.
2. **Licenses:** Prior to any herbicide use, the Contractor shall submit to the owner a current copy of the commercial pesticide applicator's license, with certification in the Forestry or other appropriate category, for each person who will be applying herbicide at the project site. A copy of each commercial pesticide applicator's license must be maintained on site at all times during completion of the work.
3. **Equipment:** Prior to commencement of any work, submit to the Owner a written description of all mechanical equipment and its intended use during the execution of the work.
4. After the work is complete, submit to the Owner "as-built" plans including a listing of all species installed, and quantities installed. Mark in red ink on the original planting plan any field changes or deviations from the original plans.

E. Related Sections: Section 2313 Best Management Practices

9004.2 Materials

A. Herbicides

1. Herbicide to be used for woody basal applications shall be triclopyr: 3,5,6-trichloro-2-pyridinyloxyacetic acid, butoxyethyl ester, trade name Garlon 4 or equivalent as approved in writing by the Engineer.
2. Herbicide to be used for woody foliar applications shall be triclopyr: 3,5,6-trichloro-2-pyridinyloxyacetic acid, butoxyethyl ester, trade name Garlon 3 or equivalent as approved in writing by Engineer.
3. Herbaceous species to be removed in areas without standing water or saturated soils shall be treated with Glyphosate, N-(phosphonomethyl) glycine, trade name Roundup or equivalent as approved in writing by Engineer.

4. Herbaceous species to be removed in areas with standing water or saturated soils shall be treated with Glyphosate, N-(phosphonomethyl) glycine in a form approved for aquatic applications such as Rodeo or equivalent as approved in writing by Engineer.
5. Selective grass herbicides and other specialty herbicides may also be used in appropriate locations.

B. Plant Materials

1. **General:** Plant materials shall consist of the species, quantity, and size as shown on the plans or as selected from Table 1 in these specifications and generally meet the following requirements:
 - a. Conform to American Standard for Nursery Stock – ANS1 Z60.1.
 - b. Furnish plants and seed that are true to name and type, sound, healthy specimens representative of the species or variety with well-formed tops and healthy root systems.
 - c. Plant material with injured bark or roots, broken branches, objectionable disfigurements, shriveled dry roots, broken pots, insect pests, diseases or other compliance deficiencies are unacceptable.
 - d. Plant materials that experience excessive growth during storage period are unacceptable.
 - e. Bare root plant materials that have broken dormancy are unacceptable.
 - f. Plant materials shall be nursery grown, winter hardy stock.
 - g. Meet or exceed specifications of Federal, State and County laws requiring inspection for plant disease and insect control and shall be labeled in accordance with U.S. Department of Agriculture Rules and Regulations under the Federal Seed Act.
 - h. All plants shall be true to name and one of each bundle or lot shall be tagged with the name and size of the plants in accordance with the standards of practice of the American Association of Nurserymen. In all cases, botanical names shall take precedence over common names.
2. **Delivery, Storage, and Handling**
 - a. Pick up plant materials in accordance with any special handling instructions and deliver to project site in good condition.
 - b. Use all means necessary to protect plant materials before during, and after installation and to protect the installed work and materials of all other trades.
 - c. Rootstock of the plant material shall be kept moist during transport and on-site storage.
 - d. Provide adequate protection of root systems from drying winds and sun while plant materials are being stored. All plant materials that cannot be planted within 1 week after delivery to the project storage area shall be "heeled-in" at a site approved by the Engineer or placed in an approved cold storage site.
 - e. Do not end or bind-tie in such a manner as to damage bark, break branches, or destroy natural shape.
 - f. Deliver plant materials to planting sites after preparations for planting have been completed and plant immediately. If planting is delayed more than 6 hours after delivery to planting sites, set materials in shade, protect from weather and mechanical damage, and keep roots moist. Heel-in bare rootstock that cannot be planted within one day at the planting site. Soak roots in water for two hours if dried out.
3. **Replacements:** In the event of damage during storage or planting, immediately make all repairs and replacements necessary to the approval of the Engineer and at no additional cost to the Owner.

4. **Cover Crop Seeding:** All grass species shall be supplied as pure live seed. Submit to the Engineer lab germination test results. Straw or hay for erosion control shall be clean, seed-free hay or threshed straw of wheat, rye, oats, or barley.

a. **Prairie Cover Crop Species List**

Scientific Name	Common Name	Pounds/Acre
<i>Avena sativa</i> (Spring)	Oats	30.00
<i>Triticum x agropyron</i> (Spr./Fall)	Red-green sterile wheat	20.00
<i>Lolium multiflorum</i> (Spring)	Annual rye	25.00
<i>Secale cereale</i> (Fall)	Winter rye	50.00

b. **Wetland Cover Crop Species List**

Scientific Name	Common Name	Pounds/Acre
<i>Echinochloa crusgalli</i>	Barnyard grass	5.00
<i>Lolium multiflorum</i>	Annual rye	25.00
<i>Polygonum</i> spp.	Smartweed	2.00 (optional)

c. **Swales Cover Crop/Bioengineering**

Scientific Name	Common Name	Pounds/Acre
<i>Echinochloa crusgalli</i> (Spring)	Barnyard grass	5.00
<i>Lolium multiflorum</i> (Spring)	Annual rye	50.00
<i>Secale cereale</i> (Fall)	Winter rye	50.00

d. **Tree Planting Zone Cover Crop**

Scientific Name	Common Name	Pounds/Acre
<i>Lolium multiflorum</i>	Annual rye	30.00
<i>Phleum pratense</i>	Timothy	2.00

5. **Herbaceous Perennial Planting:** Live herbaceous perennial plants, tubers, bulbs, and dormant rootstocks of herbaceous perennial plants shall be from within a 100-mile radius of the project site if at all possible and native to eastern Kansas and western Missouri. Species shall be true to their scientific name as specified. The number of plants installed will vary depending on the type of project, site conditions, and the purpose of the planting. Typically, only portions of a site are installed with live plants to improve aesthetics, add color, and improve establishment. Hence, forbs are presented in the tables below. However, planting is preferred to seeding in areas where seeding is less effective such as steep slopes, stream banks, shorelines, and inundated wetlands or ponds. Grasses and sedges would be ideal for such instances (refer to the seed mix lists). Recommended plantings are on 1- to 2- foot centers when using deep cell plug in selected areas. Larger sized plants can be placed wider apart. The plant species listed below are suggested for the different types of prairie and wetland habitats presented in Appendix A.

a. **Dry Prairie Species List**

Scientific Name	Common Name	Flower drift Species
<i>Amorpha canescens</i>	Lead plant	
<i>Asclepias tuberosa</i>	Butterfly milkweed	X
<i>Aster azureus</i> (A.	Sky blue aster	X

Scientific Name	Common Name	Flower drift Species
<i>oolentangiensis</i>)		
<i>Aster ericoides</i>	Heath aster	X
<i>Aster laevis</i>	Smooth blue aster	
<i>Baptisia alba</i>	White wild indigo	
<i>Ceanothus americanus</i>	New Jersey tea	
<i>Coreopsis palmata</i>	Finger coreopsis	
<i>Dalea candida</i>	White prairie clover	X
<i>Echinacea pallida</i>	Pale purple coneflower	X
<i>Euphorbia corollata</i>	Flowering spurge	
<i>Helianthus maximilliani</i>	Maximillian sunflower	
<i>Heuchera richardsonii</i>	Alum root	
<i>Kuhnia eupatorioides</i>	False boneset	
<i>Liatris aspera</i>	Rough blazing star	
<i>Monarda fistulosa</i>	Wild bergamot	X
<i>Penstemon cobaea</i>	Cobaea beard tongue	
<i>Phlox pilosa</i>	Downy phlox	X
<i>Ratibida pinnata</i>	Yellow coneflower	
<i>Silphium laciniatum</i>	Compass plant	
<i>Sisyrinchium campestre</i>	Blue-eyed grass	
<i>Solidago nemoralis</i>	Old field goldenrod	X
<i>Solidago speciosa</i>	Showy goldenrod	X
<i>Zizia aptera</i>	Heart-leaved Alexander	

b. Mesic Prairie Species List

Scientific Name	Common Name	Flower Drift Species
<i>Asclepias tuberosa</i>	Butterfly milkweed	X
<i>Aster azureus</i>	Sky blue aster	
<i>Aster laevis</i>	Smooth blue aster	
<i>Aster novae-angliae</i>	New England aster	
<i>Baptisia alba</i>	Wild false indigo	
<i>Dalea purpurea</i>	Purple prairie clover	
<i>Desmodium canadense</i>	Showy tick trefoil	
<i>Echinacea pallida</i>	Pale purple coneflower	X
<i>Eryngium yuccifolium</i>	Rattlesnake master	X
<i>Helianthus rigidus</i>	Rigid sunflower	
<i>Heliopsis helianthoides</i>	False sunflower	X
<i>Lespedeza capitata</i>	Bush clover	
<i>Liatris pycnostachya</i>	Prairie blazing star	
<i>Monarda fistulosa</i>	Bergamot	X
<i>Penstemon digitalis</i>	Fox glove beardtongue	
<i>Ratibida pinnata</i>	Yellow coneflower	X

<i>Silphium laciniatum</i>	Compass plant	
<i>Solidago rigida</i>	Stiff goldenrod	X
<i>Tradescantia ohiensis</i>	Spiderwort	

c. Wet Prairie Species List

Scientific Name	Common Name
<i>Asclepias incarnata</i>	Swamp milkweed
<i>Bidens cernua</i>	Nodding bur marigold
<i>Cicuta maculata</i>	Water hemlock
<i>Eupatorium maculatum</i>	Joe pye weed
<i>Eupatorium perfoliatum</i>	Boneset
<i>Helenium autumnale</i>	Sneezeweed
<i>Helianthus grosseserratus</i>	Sawtooth sunflower
<i>Lobelia siphilitica</i>	Great blue lobelia
<i>Lycopus americanus</i>	Water horehound
<i>Lythrum alatum</i>	Winged loosestrife
<i>Mentha arvensis</i>	Field mint
<i>Mimulus ringens</i>	Monkey flower
<i>Penthorum sedoides</i>	Ditch stone crop
<i>Rudbeckia laciniata</i>	Golden glow
<i>Silphium perfoliatum</i>	Cup plant
<i>Teucrium canadense</i>	Germander
<i>Thalictrum dasycarpum</i>	Meadow rue
<i>Verbena hastata</i>	Blue vervain
<i>Vernonia fasciculata</i>	Iron weed
<i>Veronicastrum virginicum</i>	Culvers root

d. Emergent Wetlands Species List

Scientific Name	Common Name
<i>Acorus calamus</i>	Wild calamus
<i>Alisma subcordatum</i>	Water plantain
<i>Asclepias incarnata</i>	Swamp milkweed
<i>Bidens cernua</i>	Nodding bur marigold
<i>Eleocharis obtusa</i>	Blunt spikerush
<i>Eupatorium perfoliatum</i>	Boneset
<i>Iris virginica</i>	Blue flag
<i>Lycopus americanus</i>	Water horehound
<i>Mentha arvensis</i>	Field mint
<i>Mimulus ringens</i>	Monkey flower
<i>Penthorum sedoides</i>	Ditch stone crop
<i>Sagittaria latifolia</i>	Common arrowhead
<i>Scirpus atrovirens</i>	Dark green bulrush

Scientific Name	Common Name
Scirpus validus	Great bulrush
Sparganium eurycarpum	Common bur reed

6. **Prairie and Wetland Species (Seed):** All grass species shall be supplied as pure live seed. Submit to the Engineer/plant specialist lab germination test results. Seed of all species native to Eastern Kansas or Western Missouri shall be from within a 100-mile radius of the project site if at all possible. Seed mixes and species proportions for prairie, emergent wetland, and savanna plant communities will vary depending on the type of project, site conditions, plant species aggressiveness, seed variables (e.g., cost, availability, and weight), habitat type, and the purpose of the planting. A more economic seed mix for dry, mesic, wet mesic (stream buffer edge), and wet prairies would include 6 to 8 pounds of grasses and sedges and 2 pounds of wildflowers or forbs per acre (see examples below). If quicker establishment or a showier site is desired, seed mixes can be adjusted to a higher poundage such as 10 to 15 pounds of grasses and forbs or a more even proportion of 4 pounds each of grasses/sedges and wildflowers, respectively. The higher seeding rates will also help suppress weedy vegetation as the prairie becomes established. Similar proportions can be used for savanna restorations, given that the major component is prairie. For emergent wetlands, less seed per acre is necessary. Try 1 to 2 pounds of grasses/sedges per acre and 1 to 2 pounds of wildflowers per acre. A certain amount of water drawdown will be needed for seed germination. Straw or hay for erosion control shall be clean, seed-free hay or threshed straw of wheat, rye, oats, or barley.

a. **Dry Prairie Species List**

Scientific Name	Common Name	Ounces/ Acre	Flower Drift Species
Amorpha canescens	Lead plant	1.5	
Asclepias syriaca	Common milkweed	0.50	
Asclepias tuberosa	Butterfly milkweed	1.50	
Asclepias verticillata	Whorled milkweed	1.00	
Aster azureus (A. oolentangiensis)	Sky blue aster	1.00	
Aster laevis	Smooth aster	1.00	
Avena sativa	Seed oats (cover crop)	480.00	
Baptisia bracteata	Cream false indigo	2.00	
Bouteloua curtipendula	Side oats grama	56.00	
Carex gravida	Grave sedge	4.00	
Carex meadii	Mead's sedge	4.00	
Coreopsis palmata	Finger coreopsis	1.00	
Desmodium canadense	Showy tick trefoil	1.00	
Elymus canadensis	Canada wild rye	16.00	
Helianthus maximilliani	Maximillian sunflower	1.00	X
Heliopsis helianthoides	False sunflower	1.00	X
Heuchera richardsonii	Alum root	0.50	
Lespedeza capitata	Roundhead Bushclover	1.00	
Liatris aspera	Rough blazing star	1.00	
Monarda fistulosa	Wild bergamot	2.00	X

Scientific Name	Common Name	Ounces/ Acre	Flower Drift Species
<i>Oenothera biennis</i>	Common evening primrose	1.00	X
<i>Ratibida pinnata</i>	Yellow coneflower	4.00	X
<i>Rudbeckia hirta</i>	Black-eyed Susan	4.00	X
<i>Schizachyrium scoparium</i>	Little bluestem grass	56.00	
<i>Silphium laciniatum</i>	Compass plant	1.00	
<i>Solidago rigida</i>	Stiff goldenrod	2.00	
<i>Sorghastrum nutans</i>	Indian grass	8.00	
<i>Sporobolus heterolepis</i>	Prairie dropseed	16.00	
<i>Tradescantia bracteata</i>	Prairie spiderwort	1.00	
<i>Verbena stricta</i>	Hoary vervain	2.00	X
* 10 lbs. of grasses and sedges; 2 lbs. of forbs*			

b. Mesic Prairie Species List

Scientific Name	Common Name	Ounces/ Acre	Flower Drift Species
<i>Amorpha canescens</i>	Lead plant	1.0	
<i>Andropogon gerardii</i>	Big bluestem grass	48.00	
<i>Asclepias syriaca</i>	Common milkweed	0.50	
<i>Aster azureus</i>	Sky blue aster	1.00	
<i>Aster praealtus</i>	Willow aster	1.00	
<i>Avena sativa</i>	Seed Oats (cover crop)	480.00	
<i>Baptisia australis</i>	Blue wild indigo	1.00	
<i>Bouteloua curtipendula</i>	Side oats grama	8.00	
<i>Carex meadii</i>	Mead's sedge	4.00	
<i>Carex molesta</i>	Pest sedge	4.00	
<i>Coreopsis palmata</i>	Finger coreopsis	1.00	
<i>Dalea purpurea</i>	Purple prairie clover	1.00	
<i>Desmodium canadense</i>	Showy tick trefoil	1.50	X
<i>Echinacea pallida</i>	Pale purple coneflower	2.00	
<i>Elymus canadensis</i>	Canada wild rye	8.00	
<i>Eryngium yuccifolium</i>	Rattlesnake master	1.50	
<i>Heliopsis helianthoides</i>	False sunflower	1.00	X
<i>Lespedeza capitata</i>	Bush clover	1.50	
<i>Liatris pycnostachya</i>	Prairie blazing star	1.00	
<i>Monarda fistulosa</i>	Wild bergamot	2.00	X
<i>Oenothera biennis</i>	Common evening primrose	1.00	X
<i>Panicum virgatum</i>	Switch grass	8.00	X
<i>Penstemon digitalis</i>	Smooth penstemon	0.50	
<i>Ratibida pinnata</i>	Yellow coneflower	3.00	X

Scientific Name	Common Name	Ounces/ Acre	Flower Drift Species
<i>Rudbeckia hirta</i>	Black-eyed susan	3.50	X
<i>Schizachyrium scoparium</i>	Little bluestem grass	32.00	
<i>Silphium laciniatum</i>	Compass plant	2.00	
<i>Solidago rigida</i>	Stiff goldenrod	1.00	X
<i>Solidago speciosa</i>	Showy goldenrod	1.00	
<i>Sorghastrum nutans</i>	Indian grass	24.00	
<i>Tradescantia ohiensis</i>	Ohio spiderwort	1.00	
<i>Verbena stricta</i>	Hoary vervain	1.00	
<i>Zizia aptera</i>	Heart-leaved Alexander	1.00	
* 8 lbs. of grasses and sedges; 2 lbs. of forbs*			

c. Wet Prairie (WP) and Stream Buffer Edge (Wet Mesic Prairie; BE) Species List

Scientific Name	Common Name	Seeding Rate by Zone Ounces/Acre	
		WP	BE
<i>Andropogon gerardii</i>	Big bluestem	32.00	48.00
<i>Anemone canadensis</i>	Meadow anemone	2.00	3.00
<i>Asclepias incarnata</i>	Swamp milkweed	4.00	4.00
<i>Aster novae-angliae</i>	New England aster	1.00	2.00
<i>Avena sativa</i>	Oats (cover crop)	480.00	480.00
<i>Bidens cernuus</i>	Nodding beggar-ticks	2.00	3.00
<i>Calamagrostis canadensis</i>	Blue joint grass	4.00	4.00
<i>Carex annectans</i>	Yellow-fruited sedge	4.00	--
<i>Carex cristatella</i>	Crested sedge	4.00	--
<i>Carex frankii</i>	Frank's sedge	2.00	3.00
<i>Carex vulpinoidea</i>	Fox sedge	32.00	32.00
<i>Cicuta maculata</i>	Water hemlock	1.00	--
<i>Echinochloa crusgali</i>	Barnyard grass (cover crop)	6.00	6.00
<i>Eleocharis obtusa</i>	Blunt spikerush	3.00	--
<i>Elymus virginicus</i>	Virginia Wild rye	10.00	24.00
<i>Eupatorium perfoliatum</i>	Boneset	2.00	2.00
<i>Glyceria striata</i>	Fowl manna grass	1.00	2.00
<i>Helenium autumnale</i>	Sneezeweed	1.00	--
<i>Helianthus grosseserratus</i>	Sawtooth Sunflower	3.00	4.00
<i>Juncus torreyi</i>	Torrey's rush	1.00	2.00
<i>Leersia oryzoides</i>	Rice cutgrass	2.00	
<i>Lobelia siphilitica</i>	Great blue lobelia	1.00	1.00
<i>Lycopus americanus</i>	Common water horehound	1.00	1.00
<i>Lythrum alatum</i>	Winged loosestrife	1.00	1.00

Scientific Name	Common Name	Seeding Rate by Zone Ounces/Acre	
		WP	BE
<i>Mimulus ringens</i>	Monkey flower	1.00	1.00
<i>Panicum virgatum</i>	Switch grass	4.00	4.00
<i>Rudbeckia laciniata</i>	Wild golden glow	1.00	2.00
<i>Scirpus atrovirens</i>	Dark green rush	0.50	0.50
<i>Scirpus validus</i>	Softstem bulrush	0.50	0.50
<i>Silphium perfoliatum</i>	Cup plant	2.00	2.00
<i>Solidago gigantea</i>	Tall goldenrod	2.00	--
<i>Spartina pectinata</i>	Prairie cord grass	28.00	8.00
<i>Teucrium canadense</i>	Germander, Wood sage	1.00	2.00
<i>Thalictrum dasycarpum</i>	Purple meadow rue	2.00	--
<i>Verbena hastata</i>	Blue vervain	2.00	4.00
<i>Veronicastrum virginiana</i>	Culver's root	2.00	--
* 8 lbs. of graminoids (i.e., grasses, sedges, and bulrushes) and 2 lbs. of forbs*			

d. Emergent Wetland Species List

Scientific Name	Common Name	Ounces/Acre
<i>Acorus calamus</i>	Wild calamus	1.00
<i>Alisma subcordatum</i>	Water plantain	8.00
<i>Bidens cernua</i>	Nodding beggar-ticks	4.00
<i>Calamagrostis canadensis</i>	Blue joint grass	5.00
<i>Carex hystricina</i>	Bottlebrush sedge	6.00
<i>Carex vulpinoidea</i>	Fox sedge	6.00
<i>Echinochloa crusgalli</i>	Barnyard grass (cover crop)	5.00
<i>Juncus torreyi</i>	Torrey's rush	1.00
<i>Leersia oryzoides</i>	Rice cutgrass	6.00
<i>Lobelia siphilitica</i>	Great blue lobelia	1.00
<i>Lolium multiflorum</i>	Annual rye (cover crop)	25.00
<i>Lycopus americanus</i>	Common water horehound	1.50
<i>Mimulus ringens</i>	Monkey flower	1.50
<i>Nelumbo odorata</i>	American lotus	2.00
<i>Polygonum pensylvanicum</i>	Lady's thumb	8.00
<i>Sagittaria latifolia</i>	Arrowhead	4.00
<i>Scirpus atrovirens</i>	Dark green rush	2.00
<i>Scirpus fluviatilis</i>	River bulrush	1.00
<i>Scirpus validus</i>	Softstem bulrush	1.00
<i>Sparganium americanum</i>	Common bur reed	4.00
<i>Verbena hastata</i>	Blue vervain	2.00
* 2 lbs. of graminoids (i.e., grasses, sedges, and bulrushes) and 2 lbs. of forbs*		

e. Savanna Species List

Scientific Name	Common Name	Ounces/Acre
<i>Agastache nepetoides</i>	Yellow giant hyssop	1.00
<i>Andropogon gerardii</i>	Big bluestem	2.00
<i>Anemone cylindrica</i>	Tall thimbleweed	0.50
<i>Aquilegia canadensis</i>	Wild columbine	0.50
<i>Asclepias purpurascens</i>	Purple milkweed	0.50
<i>Aster laevis</i>	Smooth blue aster	0.50
<i>Bromus pubescens</i>	Woodland brome	8.00
<i>Carex blanda</i>	Woodland sedge	1.00
<i>Carex rosea</i>	Woodland sedge	1.00
<i>Carex sparganioides</i>	Woodland sedge	1.00
<i>Desmodium canadense</i>	Showy tick trefoil	1.00
<i>Elymus canadensis</i>	Canada wild rye	4.00
<i>Eupatorium purpureum</i>	Purple joy-pye weed	0.25
<i>Geranium maculatum</i>	Wild geranium	0.25
<i>Helianthus divaricatus</i>	Woodland sunflower	0.50
<i>Hystrix patula (Elymus hystrix)</i>	Bottlebrush grass	8.00
<i>Liatis aspera</i>	Rough blazing star	1.00
<i>Monarda fistulosa</i>	Wild bergamot	1.00
<i>Panicum virgatum</i>	Switch grass	5.00
<i>Penstemon digitalis</i>	Foxglove beard tongue	0.50
<i>Ratibida pinnata</i>	Yellow coneflower	2.00
<i>Rudbeckia hirta</i>	Black-eyed susan	2.00
<i>Schizachyrium scoparium</i>	Little bluestem grass	2.00
<i>Silphium integrifolium</i>	Rosinweed	1.50
<i>Smilacina racemosa</i>	False Solomon's seal	1.00

Scientific Name	Common Name	Plants/Acres
<i>Solidago ulmifolia</i>	Elmleaf goldenrod	1.00
<i>Tradescantia ohiensis</i>	Ohio spiderwort	1.00
<i>Verbena stricta</i>	Hoary vervain	0.50
* 2 lbs. of grasses and sedges; 1 lb. of forbs*		

7. **Tree and Shrub Species:** Seedling protection tubes shall be 4" diameter, 24" tall, photodegradable plastic, with a 2-year life span, such as Pro/Gro tubes manufactured by Protex, or equivalent with written approval by the Engineer. Trees shall be from within a 150-mile radius of the project site. All trees shall be 1 to 2" caliber bare root nursery grown stock unless approved in writing by the Engineer.

a. Savanna Species List

Scientific Name	Common Name	Plants/Acres
-----------------	-------------	--------------

<i>Corylus americana</i>	Hazelnut	16
<i>Quercus alba</i>	White oak	25
<i>Quercus macrocarpa</i>	Bur oak	25
<i>Quercus rubra</i>	Red oak	25

9004.3 Selective Woody Brush Removal

A. **Description:** This section includes the selective cutting and disposal of woody brush including trees and shrubs.

B. **Method**

1. The Contractor will cut all woody species designated for removal in up to approximately 12.5 acres of woods with hand tools including, but not necessarily limited to, gas powered chain saws, gas powered clearing saws, bow saws, and loppers.
2. All stumps shall be cut flat with no sharp points, and to within two inches of surrounding grade.
3. Removal of undesirable woody species shall preferentially occur when the ground is frozen.
4. Stumps shall be left in the ground and not removed. All stumps shall be treated with an approved herbicide mixed with a marking dye.
5. Girdling may also be used in combination with cutting and stump herbicide treatment if approved in writing by the owner. Trees to be girdled shall have a one inch deep notch cut completely around the trunk approximately 36" above surrounding grade. A basal application of an approved herbicide shall also be used following label directions.
6. Stack cut brush in piles not to exceed eight (8) feet in height by twelve (12) foot in diameter. Piles shall be spaced as necessary to minimize dragging of cut material over long distances. Piles shall be located in open areas without canopy branches of preserved trees overhanging the piles. Piles shall be burned on site. Ensure no debris (rubble, plastic, etc.) other than the cut brush is placed in the burn piles.
7. A supply of chemical absorbent shall be maintained at the project site. Any chemical spills shall be properly cleaned up and reported to the owner within 24 hours.
8. The Contractor shall maintain copies at the project site of all current pesticide applicator's licenses, herbicide labels, and MSDS's (Material Safety Data Sheets) for all chemicals utilized during completion of the work.
9. Species designated for removal shall be determined for a specific site and may include some or all of the following invasive plant species or noxious weeds:

Common Name	Scientific Name	Disposition
Saltcedar	<i>Tamarix</i> spp.	Remove all
Boxelder	<i>Acer negundo</i>	Remove all
Russian olive	<i>Elaeagnus angustifolia</i>	Remove all
Autumn olive	<i>Elaeagnus umbellata</i>	Remove all
Common buckthorn	<i>Rhamnus cathartica</i>	Remove all
Multiflora rose	<i>Rosa multiflora</i>	Remove all
Morrow's honeysuckle	<i>Lonicera morrowii</i>	Remove all
Tartarian honeysuckle	<i>Lonicera tatarica</i>	Remove all

Common Name	Scientific Name	Disposition
Amur honeysuckle	<i>Lonicera maackii</i>	Remove all
Japanese honeysuckle	<i>Lonicera japonica</i>	Remove all
Showy fly honeysuckle	<i>Lonicera x bella</i>	Remove all
Prickly ash	<i>Zanthoxylum americanum</i>	Reduce by 50%
Sericea lespedeza	<i>Lespedeza cuneata</i>	Remove all
Red elm	<i>Ulmus rubra</i>	Reduce by 50%
Green ash	<i>Fraxinus pennsylvanica subintegerrima</i>	Reduce by 50%
Gray dogwood	<i>Cornus racemosa</i>	Reduce by 50%
Rough-leaved dogwood	<i>Cornus drummondii</i>	Reduce by 50%
Winter creeper	<i>Euonymus fortunei</i>	Remove all

C. Clean-Up, Removal and Repair

- Clean up:** The work area shall be kept free of debris by the Contractor. At no time shall empty herbicide containers, trash, or other material be allowed to accumulate at the project site. All tools shall be kept in appropriate carrying cases, toolboxes, etc. Parking areas, roads, sidewalks, paths and paved areas shall be kept free of mud and dirt.
- Removal:** After work has been completed remove tools, empty containers, and all other debris generated by the Contractor.
- Repair:** Repair any damages caused by the Contractor during completion of the work described in this Section. Said damages may include, but are not limited to, tire ruts in the ground, damage to lawn areas, damage to trails, etc. In the event any vegetation designated to be preserved is damaged, notify the owner within 24 hours. The Contractor shall be liable for remedying said damages to plant materials.

D. Inspection

- After completion of selective woody brush removal, the Contractor shall schedule with the Owner a provisional acceptance inspection of the work.
- After provisional acceptance of selective woody brush removal, the Contractor shall conduct a year-end inspection of work areas. Within five business days of the inspection, the Contractor shall notify the owner in writing of the results of the inspection, and noting any stumps that have re-sprouted.

E. Acceptances and Guarantee

- Provisional Acceptance:** The work shall be provisionally accepted by the Owner after initial selective woody brush removal is completed per the given plans and specifications, and the Contractor has completed all clean up, removal, and repair as described in this section. Selective woody brush removal shall be considered 75% complete at the time of provisional acceptance.
- Final Acceptance:** Selective woody brush removal shall be considered 100% complete after the Contractor has complied with all provisions of the Guarantee described in this section.
- Guarantee:** The Contractor guarantees not more than 10% of the cut stumps shall be re-sprouting at any time. The Contractor shall guarantee the work until one full year after brushing.

9004.4 Herbaceous Species Removal

- Description:** This section includes the eradication of herbaceous species, including grasses and forbs. This work will occur in the areas to be restored to prairies, areas to be restored to wetlands and areas to receive native landscaping treatments.

B. Method

1. The Contractor will treat all vegetation within targeted areas with an approved herbicide, applied by a certified application, in accordance with applicable laws. Herbicide application instructions given on the label shall be followed at all times.
2. Targeted areas may be shown on plans or located in the field by the Engineer.
3. Care shall be taken not to affect vegetation outside of target areas.
4. A supply of chemical absorbent shall be maintained at the project site. Any chemical spills shall be properly cleaned up and reported to the Engineer within 24 hours.
5. The Contractor shall maintain copies at the project site of all current pesticide applicator's licenses, herbicide labels, and MSDS's (Material Safety Data Sheets) for all chemicals utilized during completion of the work.
6. Herbicide may be applied using a backpack sprayer, a hand-held wick applicator, or a vehicle mounted high-pressure spray unit, as specified by the chemical label, in accordance with applicable laws.
7. Species designated for removal shall be determined for a specific site and may include some or all of the following invasive plant species and noxious weeds:

Common Name	Scientific Name	Disposition
Crown vetch	<i>Coronilla varia</i>	Remove all
Purple loosestrife	<i>Lythrum salicaria</i>	Remove all
Cut-leaf teasel	<i>Dipsacus laciniatus</i>	Remove all
Fuller's teasel	<i>Dipsacus fullonum</i>	Remove all
Garlic mustard	<i>Alliaria petiolata</i>	Remove all
Musk thistle	<i>Carduus nutans</i>	Remove all
Canada thistle	<i>Cirsium arvense</i>	Remove all
Bull thistle	<i>Cirsium vulgare</i>	Remove all
Scotch thistle	<i>Onopordum acanthium</i>	Remove all
Yellow and white sweet clover	<i>Mellilotus officinalis, M. alba</i>	Remove all
Kudzu	<i>Pueraria lobata</i>	Remove all
Field bindweed	<i>Convolvulus arvensis</i>	Remove all
Russian knapweed	<i>Centaurea picris</i>	Remove all
Pignut	<i>Hoffmannseggia densiflora</i>	Remove all
Burrageweed	<i>Franseria tomentosa; F. discolor</i>	Remove all
Leafy spurge	<i>Euphorbia esula</i>	Remove all
Hoary cress	<i>Lepidium draba</i>	Remove all
Quackgrass	<i>Agropyron repens</i>	Remove all
Reed canary grass	<i>Phalaris arundinacea</i>	Remove all
Johnson grass	<i>Sorghum halepense</i>	Remove all
Marijuana	<i>Cannabis sativa</i>	Remove all
Caucasian bluestem	<i>Bothriochloa bladhi</i>	Remove all
Silver beardgrass	<i>Bothriochloa laguroides</i>	Remove all
Smooth brome	<i>Bromus inermis</i>	Remove all

Common Name	Scientific Name	Disposition
Tall fescue	<i>Festuca arundinacea</i>	Remove all

Other non-native species, not listed here, may also preclude the establishment of native vegetation, and should be removed if found on-site.

C. Clean-Up, Removal and Repair

1. **Clean-Up:** The work area shall be kept free of debris by the Contractor. At no time shall empty herbicide containers, trash, or other material be allowed to accumulate at the project site. All tools shall be kept in appropriate carrying cases, toolboxes, etc. Parking areas, roads, sidewalks, paths and paved areas shall be kept free of mud and dirt.
2. **Removal:** After work has been completed remove tools, empty containers, and all other debris generated by the Contractor, in accordance with the chemical label and applicable laws.
3. **Repair:** Repair any damages caused by the Contractor during completion of the work described in this Section. Said damages may include, but are not limited to, tire ruts in the ground, damage to lawn areas, damage to trails, etc. In the event any vegetation outside of targeted areas is damaged, notify the Owner within 24 hours. The Contractor shall be liable for remedying said damages to plant materials.

D. Inspection

1. After completion of herbaceous species removal, the Contractor shall schedule with the Owner a provisional acceptance inspection of the work.
2. After provisional acceptance of herbaceous species removal, the Contractor shall conduct monthly inspections of work areas until the end of the current growing season. Within five business days of the inspection, the Contractor shall notify the Engineer by telephone of the results of the inspection.

E. Acceptance and Guarantee

1. **Provisional Acceptance:** The work shall be provisionally accepted by the Owner after initial herbaceous species removal is completed per the given plans and specifications, and the Contractor has completed all clean up, removal, and repair as described in 3.2 of this section. Herbaceous species removal shall be considered 90% complete at the time of provisional acceptance.
2. **Final Acceptance:** Herbaceous species removal shall be considered 100% complete after the Contractor has complied with all provisions of the Guarantee described in 3.4C of this section.
3. **Guarantee:** The Contractor guarantees not more than 10% vegetative cover within the treated area at any time. The Contractor shall guarantee the work until provisional acceptance of Seeding, Herbaceous perennial planting, and/or tree and shrub planting in the targeted area.

9004.5 Soil Preparation

A. Description: This section includes preparation of soil prior to seeding and/or planting for areas to be restored to prairies, wetlands and native landscaping in areas currently dominated by agricultural or weedy vegetation, old fields, etc. All herbaceous species removal will be done prior to soil preparation.

B. Method

1. Prior to seeding and planting, rotovate soils to produce a fine seedbed.
2. Soils shall not have a measured compaction greater five pounds per square inch, based on Lang or Cone penetrometer measurements, at the time of seeding or planting unless otherwise stated on the plans or in the specifications. If ten percent or more of penetrometer readings are greater than five

pounds per square inch, disc, rotovate, and/or chisel plow said areas as necessary to reduce compaction.

3. Re-check soil compaction as described above after tillage. Repeat treatment until ninety percent or more of penetrometer readings are less than five pounds per square inch.
4. Remove all foreign matter larger than one inch in any dimension from the areas to be seeded and/or planted.

C. Clean-Up, Removal and Repair

1. **Clean-Up:** After soil preparation is complete, clean up any remaining materials, debris, trash, etc. Avoid driving over the area to minimize additional compaction.
2. **Repair:** Repair any damages caused by the Contractor during completion of the work described in this Section.

D. Inspection: After completion of soil preparation, the Contractor shall schedule with the Owner a final acceptance inspection of soil preparation.

E. Acceptance and Guarantee:

1. **Final Acceptance:** this portion of the work shall be considered 100% complete after the Contractor has completed soil preparation, and completed all required clean up as described in this section.

9004.6 Cover Crop Seeding

A. Description: This section includes installation of cover crop seed in any area of disturbed soil that may or may not be final planted to native, plantings and species.

B. Method

1. Seeds shall have proper stratification and/or scarification to break seed dormancy for spring planting.
2. Seeding shall be preferentially conducted as a late fall dormant seeding (after December 1) or in early spring (as soon as the soil is free of frost and in a workable condition but no later than July 15).
3. All seed shall be preferentially installed with a rangeland type grain drill or no-till planter, such as by Truax, or equivalent as approved in writing by the Owner.
4. If soil is too wet to install seed as described above, a mechanical broadcast seeder, such as by Cyclone, shall be used. Hand broadcasting of seed may also be employed. Within 24 hours, or as soon as site conditions permit, broadcast seeded areas shall be rolled or dragged perpendicular to the slope.
5. Within seven days of seeding, crimp 2,000 pounds per acre of straw or hay for erosion control onto slopes greater than one foot horizontal to five foot vertical (1:5).
6. If area to be seeded was treated with herbicide, seeding shall occur no less than 14 days after herbicide application.

C. Clean-Up, Removal and Repair

1. **Clean-Up:** The work area shall be kept free of debris by the Contractor. After seed installation is complete, clean up any remaining materials, debris, trash, etc. Avoid driving over seeded areas to minimize disturbance
2. **Removal:** After work has been completed remove any tools, equipment, empty containers, and all other debris generated by the Contractor.

3. **Repair:** Repair any damages caused by the Contractor during completion of the work described in this section.
- D. **Inspection:** After completion of seeding, the Contractor shall schedule with Owner a provisional acceptance inspection of the work.
- E. **Acceptance and Guarantee**
 1. **Provisional Acceptance:** The work shall be considered 90% complete after all seed has been installed and the Contractor has completed all required clean up, removal, and repair as described in this section.
 2. **Final Acceptance:** The work shall be considered 100% complete after the Contractor has met or exceeded the performance standards given in this section, and completed all required clean up, removal, and repair as described in this section.
 3. The Contractor shall guarantee seeded areas will meet or exceed the following performance criteria one full growing season after provisional acceptance: 70% plant cover.

9004.7 Herbaceous Perennial Planting

- A. **Description:** This section includes installation of live herbaceous perennial plants, tubers, bulbs, and dormant rootstocks of herbaceous perennial plants.
- B. **Method**
 1. Planting of all live herbaceous perennial plants, tubers, bulbs, and dormant rootstocks of herbaceous perennial plants shall be completed after May 15 but no later than July 15.
 2. All live herbaceous plants shall be potted, two year old nursery grown stock unless approved in writing by the Owner.
 3. All live herbaceous perennial plants, tubers, bulbs, and dormant rootstocks of herbaceous perennial plants shall be approved by the Owner prior to installation.
 4. Provide healthy, vigorous live herbaceous perennial plants; provide freshly dug tubers, bulbs, and dormant rootstocks of herbaceous perennial plants. Do not use materials that have been in cold storage for longer than 45 days.
 5. Deliver live herbaceous perennial plants, tubers, bulbs, and dormant rootstocks of herbaceous perennial plants to project site after preparations for planting have been completed.
 6. Live herbaceous perennial plants, tubers, bulbs, and dormant rootstocks shall be packed in such a manner as to insure adequate protection against wind damage, desiccation, and other physical damage while in transit.
 7. If planting is delayed more than four hours after delivery, keep plants in refrigerated container or set plants in shade protected from weather and mechanical damage, and keep moist and cool.
 8. Live herbaceous emergent perennial plants, tubers, bulbs, and dormant rootstocks shall be installed in 0-6" depth of water.
 9. Emergent live herbaceous perennial plants, tubers, bulbs, and dormant rootstocks of herbaceous perennial plants shall be clustered into groups of 25-50 individuals of the same species.
 10. Dry prairie, mesic prairie, wet prairie, and wetlands live herbaceous perennial plants, tubers, bulbs, and dormant rootstocks of herbaceous perennial plants shall be clustered into groups of 75-125 individuals of randomly mixed species from the species lists given in this section.

11. All live herbaceous perennial plants, tubers, bulbs, and dormant rootstocks of herbaceous perennial plants shall be adequately healed in to prevent desiccation.
12. All groupings of live herbaceous emergent perennial plants, tubers, bulbs, and dormant rootstocks of herbaceous perennial plants shall be protected from wildlife herbivory, if necessary, on all four sides by 36-48" high fencing attached to wooden stakes. The Contractor shall submit shop drawings, including a materials list, to the Owner for approval prior to installation. Said fencing shall be removed by the Contractor one full growing season after installation or as otherwise directed by the Owner.
13. If planting into an area treated with herbicide, plant materials shall be installed not less than 14 days after herbicide treatment.

C. Clean-Up, Removal and Repair

1. **Clean-Up:** The work area shall be kept free of debris by the Contractor. After the work is complete, clean up any remaining materials, plant containers, debris, trash, etc. Avoid driving or walking over planted areas to minimize disturbance.
2. **Removal:** After work has been completed remove any tools, equipment, empty containers, and all other debris generated by the Contractor.
3. **Repair:** Repair any damages caused by the Contractor during completion of the work described in this section.

D. Inspection: After completion of planting and fencing, the Contractor shall schedule with the Owner a provisional acceptance inspection of the work.

E. Acceptance and Guarantee

1. **Provisional Acceptance:** the work shall be considered 90% complete after initial planting and construction of fencing, and after the Contractor has completed all required clean up, removal, and repair as described in this section.
2. **Final Acceptance:** The work shall be considered 100% complete after the Contractor has met or exceeded the performance standards given in this section, completed all required clean up, removal, and repair as described in this section, and removed fencing as described in this section.
3. The Contractor shall guarantee planted areas will meet or exceed the following performance criteria one full growing season after provisional acceptance: 10% survivorship of all planted species

9004.8 Seeding

A. Description: This section includes installation of seed.

B. Method

1. Seeds shall have proper stratification and/or scarification to break seed dormancy for spring planting.
2. All legumes shall be inoculated with proper rhizobia at the appropriate time prior to planting.
3. Seeding shall be preferentially conducted as a late fall dormant seeding (after November 1) or in early spring (as soon as the soil is free of frost and in a workable condition but no later than July 15).
4. All seed on drivable slopes shall be preferentially installed with a rangeland type grain drill or no-till planter, such as by Truax, or equivalent as approved in writing by the Owner.
5. If soil is too wet to install seed as described in 3.1D. above, a mechanical broadcast seeder, such as by Cyclone, shall be used. Hand broadcasting of seed may also be employed. Within 24 hours, or as soon as site conditions permit, broadcast seeded areas shall be rolled or dragged perpendicular to the slope. Hydro seeding and mulching onto a lightly disked soil surface is also an acceptable method.

Contractor shall provide specifications on the nature of the equipment, mulching system, and tackifier that would be used if hydro seeding/mulching is the chosen procedure.

6. Within seven days of seeding, crimp 2,000 pounds per acre of clean weed free straw or hay for erosion control onto slopes greater than one foot horizontal to five foot vertical (1:5).
7. If area to be seeded was treated with herbicide, seeding shall occur no less than 14 days after herbicide application.

C. Clean-Up, Removal and Repair

1. **Clean-Up:** The work area shall be kept free of debris by the Contractor. After seed installation is complete, clean up any remaining materials, debris, trash, etc. Avoid driving over seeded areas to minimize disturbance.
2. **Removal:** After work has been completed remove any tools, equipment, empty containers, and all other debris generated by the Contractor.
3. **Repair:** Repair any damages caused by the Contractor during completion of the work described in this section.

D. Inspection: After completion of seeding, the Contractor shall schedule with Owner a provisional acceptance inspection of the work.

E. Acceptance and Guarantee

1. **Provisional Acceptance:** The work shall be considered 90% complete after all seed has been installed and the Contractor has completed all required clean up, removal, and repair as described in this section.
2. **Final Acceptance:** The work shall be considered 100% complete after the Contractor has met or exceeded the performance standards given in this section, and completed all required clean up, removal, and repair as described in this section.
3. The Contractor shall guarantee seeded areas will meet or exceed the following performance criteria one full growing season after provisional acceptance: 70% plant cover, seedlings of three planted grass/sedge species found, and seedlings of three planted forb species found.
4. The Contractor shall guarantee seeded areas will meet or exceed the following performance criteria two full growing seasons after provisional acceptance: 80% plant cover, 5% cover by planted native grass/sedge species, 10% cover by planted forb species, and 20% of planted species are found.

9004.9 Tree and Shrub Planting

A. Description: This section includes planting of trees and shrubs.

B. Method

1. Planting of trees shall be completed as soon as the soil is free of frost and in a workable condition but no later than July 15.
2. All trees shall be approved by the Engineer prior to installation.
3. Provide healthy, vigorous, freshly dug plant materials. Do not use materials that have been dug more than 30 days in advance.
4. Deliver trees to project site after preparations for planting have been completed.
5. Trees shall be packed in such a manner as to insure adequate protection against wind damage, desiccation, and other physical damage while in transit.

6. If planting is delayed more than four hours after delivery, keep plants in refrigerated container or set plants in shade protected from weather and mechanical damage, and keep moist and cool.
7. Trees shall be randomly planted from the species lists given in this section.
8. A seedling protection tube shall be installed around every tree and shrub within seven days of planting. Seedling protection tubes shall be secured to the ground with a 3/8"x36" bamboo stake and plastic cable tie. Seedling protection tubes shall not be removed by the Contractor unless directed by the Engineer.
9. If planting into an area treated with herbicide, plant materials shall be installed not less than 14 days after herbicide treatment.

C. Clean-Up, Removal and Repair

1. **Clean-Up:** The work area shall be kept free of debris by the Contractor. After the work is complete, clean up any remaining materials, plant containers, debris, trash, etc. Avoid driving or walking over planted areas to minimize disturbance.
2. **Removal:** After work has been completed remove any tools, equipment, empty containers, and all other debris generated by the Contractor.
3. **Repair:** Repair any damages caused by the Contractor during completion of the work described in this Section.

D. Inspection: After completion of the work, the Contractor shall schedule with the Owner a provisional acceptance inspection of the work.

E. Acceptance and Guarantee

1. **Provisional Acceptance:** The work shall be considered 90% complete after initial planting and installation of seedling protection tubes, and after the Contractor has completed all required clean up, removal, and repair as described in this section.
2. **Final Acceptance:** The work shall be considered 100% complete after the Contractor has met or exceeded the performance standards given in this section, and has completed all required clean up, removal, and repair as described in this section.
3. The Contractor shall guarantee planted areas will meet or exceed the following performance criteria one full growing season after provisional acceptance: 50% survivorship of all planted species.

9004.10 Management

A. Description: Seeding, herbaceous perennial planting, tree and shrub planting, woody brush removal.

B. Herbicide Application

1. The Contractor will treat all undesirable species with an approved herbicide. Herbicide application instructions given on the label shall be followed at all times.
2. Undesirable species include plant species not native to Kansas or Missouri.
3. Care shall be taken not to affect surrounding vegetation. The Contractor may be required to replant any vegetation affected by herbicide outside of targeted species.
4. A supply of chemical absorbent shall be maintained at the project site. Any chemical spills shall be properly cleaned up and reported to the Owner within 24 hours.
5. The Contractor shall maintain copies at the project site of all current pesticide applicator's licenses, herbicide labels, and MSDS's (Material Safety Data Sheets) for all chemicals utilized during completion of the work.

6. Herbicide may be applied using a backpack sprayer, a hand-held wick applicator, or a vehicle mounted high-pressure spray unit.
7. For bidding purposes, Contractor shall provide costs for three herbicide control treatments over an Owner-specified number of acres.

C. Mowing

1. The Contractor shall mow all seeded areas to a height of 8-12" after vegetation in said areas reach a height of 30" and before non-native species go to seed during the first two growing seasons after planting.
2. For bidding purposes, Contractor shall provide costs for providing three mowings over an Owner-specified number of acres.

D. Prescribed Burning

1. Prescribed burning shall be the primary method of long-term ecological management and weed control of planting areas at the project site. Burning shall be conducted annually after the second full growing season or as directed by the Owner.
2. Prior to the commencement of prescribed burning, the Contractor shall compile a burn plan that outlines a plan of action, identifies contingencies, and lists the names and phone numbers of emergency agencies (fire department, police department, etc.). Proper notice of intent to burn shall be given.
3. The Contractor shall apply for and receive all required permits prior to the commencement of prescribed burning.
4. For bidding purposes, contractor shall provide costs for two burns over an Owner-specified number of acres.

E. Clean-Up, Removal and Repair

1. **Clean-Up:** The work area shall be kept free of debris by the Contractor. At no time shall empty herbicide containers, trash, or other material be allowed to accumulate at the project site. All tools shall be kept in appropriate carrying cases, toolboxes, etc. Parking areas, roads, sidewalks, paths, and paved areas shall be kept free of mud and dirt.
2. **Removal:** After work has been completed remove tools, empty containers, and all other debris generated by the Contractor.
3. **Repair:** Repair any damages caused by the Contractor during completion of the work described in this Section. Said damages may include, but are not limited to, tire ruts in the ground, damage to lawn areas, damage to trails, etc. The Contractor shall be liable for remedying damages to plant materials and property at no cost to the Owner caused by Contractor negligence during completion of the work.
4. **Inspection:** At the request of the Engineer, the Contractor shall schedule an inspection with the Owner to review the work completed by the Contractor pursuant to this section.
5. **Acceptance and Guarantee:** Final acceptance: Management shall be considered 100% complete after the Contractor has complied with all parts of this section.

9004.11 Odds & Ends

A. Maintenance:

1. **General:** Maintain all components of the structure, starting with the clearing operations and continuing for 30 calendar days after all planting is complete and approved by the Engineer.
2. **Work Included:**

- a. Maintenance shall include erosion and sediment control. Construction operations will be carried out in such a manner that erosion will be controlled and water and air pollution minimized. State and local laws concerning pollution abatement will be followed.
 - b. Maintenance shall include grading all borrow areas to provide proper drainage and left in a slightly better condition. All exposed surfaces of the embankment, spillway, spoil and borrow areas, and berms shall be stabilized by seeding, limin, fertilizing, and mulching.
 - c. Maintenance shall include all watering, weeding, cultivating, spraying, and pruning necessary to keep the plant materials in a healthy growing condition and to keep the planted areas neat and attractive throughout the maintenance period.
 - d. Provide all equipment and means for proper application of water to planted areas.
 - e. Protect all planted areas against damage, including erosion and trespassing, by providing and maintaining proper safeguards.
3. **Replacements:**
- a. At the end of the maintenance period, all plant material shall be in a healthy growing condition.
 - b. During the maintenance period, should the appearance of any plant indicate weakness and probability of dying, immediately replace that plant with a new and healthy plant of the same type and size without additional cost to the Engineer.
4. **Extension of Maintenance Period:** Continue the maintenance period at no additional cost to the Owner until all previously noted deficiencies have been corrected, at which time the final inspection shall be made.
- B. **Acceptance:**
1. The Contractor shall guarantee 80% survival of tree and shrub planting stock and 95% herbaceous.
 2. Ninety days after planting, after "leaf-out", a final inspection shall be made by the Contractor and the Engineer.
 3. The Contractor shall satisfactorily replace any seedlings or shrubs up to 80% of the total number specified herein and up to 95% of the total area of herbaceous planting. With this replacement, as approved by the Engineer, the Contractor shall be issued a letter of acceptance for work covered by this Section of the Specifications in accordance with applicable provisions stated in the Special Provisions.
 4. **Clean-Up:** General: During the progress of this work, and upon completion, thoroughly clean the project area and remove and properly dispose of all resultant dirt, debris and other waste materials.

RECOMMENDED NATIVE PLANT MATERIALS FOR BMPs

Plant Species	Annual/Perennial	Cool/Warm or 1st Flower	Local or Regional	Short/Medium/Tall	Leaf/Stem/Flower Color	Moist/Wet/Salt Tolerant	Riparian Buffer	Dry Swale	Wet Swale	Filter Strip	Infiltration Basin	Infiltration Trench	Sand Filter	Pervious Pavement	Bioretention	Rain Garden	ED Wetland	Phased Const.
UPLANDS																		
GRAMINOIDS																		
Big Bluestem (<i>Andropogon gerardii</i>)	P	W	L	T	G	M	X	X	X	X	X	X			X	X	X	X
Side Oats Grama (<i>Bouteloua curtipendula</i>)	P	W	L	M	P/G	D/M	X	X	X	X	X	X	X		X			
Blue Grama (<i>Bouteloua gracilis</i>)	P	W	R	S	BG	D	X	X		X	X	X	X	X	X			
Hairy Grama (<i>Bouteloua hirsuta</i>)	P	W	R	S	BG	D	X	X		X	X	X	X	X	X			
Woodland Brome <i>Bromus pubescens</i>	P	C	L	M	G	M		X		X	X	X			X			X
Buffalograss (<i>Buchloe dactyloides</i>)	P	W	R	S	BG/G	D/M/S	X	X		X	X	X	X	X	X			
Woodland Sedge (<i>Carex blanda</i>)	P	C	L	S/M	GR	D/M	X										X	
Mead's Sedge (<i>Carex meadii</i>)	P	C	L	S	GR	D		X									X	
Pest Sedge (<i>Carex molesta</i>)	P	C	L	S/M	GR	D/M	X	X	X		X	X			X	X		
Wood Sedge (<i>Carex rosea</i>)	P	C	R	S	GR	M/W	X								X		X	
Pointed Broom Sedge (<i>Carex scoparia</i>)	P	C	R	M	BR	M/W			X						X	X	X	
Woodland Sedge (<i>Carex sparganioides</i>)	P	C	R	S/M	GR	M			X						X	X	X	
Canada Wildrye (<i>Elymus canadensis</i>)	P	C	L	T	G	D/M	X	X		X	X	X	X					
Virginia Wildrye (<i>Elymus virginicus</i>)	P	C	L	M	G	M	X	X	X	X	X	X			X	X	X	
Bottlebrush Grass <i>Hystrix patula</i> (<i>Elymus hystrix</i>)	P	C	R	M	G	M		X		X	X	X			X			
Switchgrass (<i>Panicum virgatum</i>)	P	W	L	T	G	M/S	X	X	X	X	X	X			X	X	X	X
Western Wheatgrass (<i>Pascopyrum smithii</i>)	P	C	R	M	G/YG	M/S	X	X		X					X			X
Little Bluestem (<i>Schizachyrium scoparium</i>)	P	W	L	M	BG/G	D/M	X	X	X	X	X	X	X		X		X	X
Indian Grass (<i>Sorghastrum nutans</i>)	P	W	L	T	G	D/M	X	X	X	X	X	X	X		X		X	X
Prairie Cordgrass (<i>Spartina pectinata</i>)	P	W	L	T	G/BG	M/S	X		X	X	X	X			X	X	X	
Prairie Dropseed (<i>Sporobolus heterolepis</i>)	P	W	L	M	G	D/M	X	X		X	X	X	X		X			

FORBS																	
Meadow Garlic (Allium canadense)	P	M	R	S	PK	D/M	X	X		X					X	X	X
Leadplant (Amorpha canescens)	P	M	L	M	B	M	X	X		X					X	X	X
Thimbleweed (Anemone cylindrica)	P	M	R	S	G	D/M	X	X		X	X				X	X	X
Wild Columbine (Aquilegia canadensis)	P	E	L	M	R	D/M	X	X		X					X	X	X
Common Milkweed (Asclepias syriaca)	P	E	L	M	PK	M	X	X	X	X					X	X	X
Butterfly Milkweed (Asclepias tuberosa)	P	E	L	M	OR	D/M	X	X		X	X				X	X	X
Whorled Milkweed (Asclepias verticillata)	P	M	L	S	W	D/M	X	X		X	X				X	X	X
Sky Blue Aster (Aster azureus)	P	L	L	M	B	D/M	X	X		X					X	X	X
Heath Aster (Aster ericoides)	P	M	L	S/M	W	D/M	X	X		X	X				X	X	X
Smooth Blue Aster (Aster laevis)	P	L	L	M	P/B	D/M	X	X		X	X				X	X	X
New England Aster (Aster novae-angliae)	P	L	L	M/T	B	M/W	X	X		X	X				X	X	X
Willowleaf Aster (Aster praealtus)	P	L	L	M/T	W/Y	M			X						X	X	X
Silky Aster (Aster sericeus)	P	L	R	S	P/B	D	X	X		X	X						
Wild False Indigo (Baptisia alba var. macrophylla)	P	E	L	M/T	W/Y	M	X	X		X	X				X	X	X
Blue Wild Indigo (Baptisia australis)	P	E	L	M	B	D/M	X	X	X	X					X	X	X
Cream False Indigo (Baptisia bracteata)	P	E	L	S	W	D/M	X	X		X					X	X	X
American Bellflower (Campanula americanum)	P	M	L	T	B	D/M	X			X					X	X	
Partridge Pea (Cassia fasciculata)	A	M	L	S	Y	D/M	X	X		X					X	X	X
Finger Coreopsis (Coreopsis palmata)	P	M	L	M	Y	D/M		X		X						X	
White Prairie Clover (Dalea candida)	P	E	L	S	W	D/M	X	X		X					X	X	X
Purple Prairie Clover (Dalea purpurea)	P	M	L	M	P	M	X	X		X	X				X	X	X
Illinois Bundleflower (Desmanthus illinoensis)	P	M	L	M	G/BR	M	X	X		X					X		
Showy Tick Trefoil (Desmodium canadense)	P	M	L	S/M	P	M/D	X	X		X	X				X	X	X
Illinois Tick Trefoil (Desmodium illinoense)	P	M	L	S/M	P	M/D	X	X		X	X				X	X	X
Purple Coneflower (Echinacea purpurea)	P	M	R	M	P	M	X	X		X					X	X	X
Pale Purple Coneflower (Echinacea pallida)	P	M	L	M	P	M	X	X		X					X	X	X
Rattlesnake Master (Eryngium yuccifolium)	P	M	L	M	W	D/M		X								X	
Joe Pyeweed (Eupatorium maculatum)	P	M	L	M	P	M/W	X	X	X	X					X	X	X
Flowering Spurge (Euphorbia corollata)	P	M	L	S	W	D/M	X	X		X	X				X	X	X
Cream Gentian (Gentiana alba)	P	L	R	M	W	D/M	X	X		X					X	X	X

Sneezeweed (Helenium autumnale)	P	L	R	S	Y	M/W	X	X	X	X							X	X	X
Maximilian Sunflower (Helianthus maximiliani)	P	L	L	T	Y	M	X	X		X	X						X	X	X
Stiff Sunflower (Helianthus rigidus or H. pauciflorus)	P	L	L	T	Y	D/M	X	X		X	X						X	X	X
Sawtooth Sunflower (Helianthus grosseserratus)	P	L	L	T	Y	M/W	X		X	X							X	X	X
False Sunflower (Heliopsis helianthoides)	P	M	R	M	Y	D/M	X	X		X							X	X	X
Alum Root (Heuchera richardsonii)	P	M	L	S	GR	D/M	X	X		X	X						X	X	X
Round-headed Bush Clover (Lespedeza capitata)	P	M	L	M	B	D/M	X	X		X							X	X	X
Rough Blazing Star (Liatris aspera)	P	L	L	M	P/R	D/M	X	X		X							X	X	X
Prairie Blazingstar (Liatris pycnostachya)	P	M	L	M	P/R	M	X	X		X	X						X	X	X
Great Blue Lobelia (Lobelia siphilitica)	P	L	L	M	B	M/W	X	X	X	X							X	X	X
Wild Bergamot (Monarda fistulosa)	P	M	L	M/T	P/B	D/M	X	X		X							X	X	X
Large-fruited Evening Primrose (Oenothera macrocarpa)	P	M	L	S	Y	D		X		X								X	
Showy Evening Primrose (Oenothera speciosa)	P	E	L	S	W	D/M	X	X		X							X	X	X
Smooth Penstemon (Penstemon digitalis)	P	E	L	M	W	M/W	X	X	X	X							X	X	X
Large-flowered Beard Tongue (Penstemon grandiflorus)	P	E	R	M	P/B	D	X	X		X	X								
Downy Phlox (Phlox pilosa)	P	E	R	S	PK	D/M	X	X	X	X							X	X	X
Prairie Cinquefoil (Potentilla arguta)	P	M	R	S	Y	D/M	X	X		X							X	X	X
Slender Mountain Mint (Pycnanthemum tenuifolium)	P	M	L	S	W	D/M	X	X		X							X	X	X
Yellow Coneflower (Ratibida pinnata)	P	M	L	M	Y	D/M	X	X		X	X						X	X	X
Black-eyed Susan (Rudbeckia hirta)	A	E	L	M	Y	M	X	X		X	X						X	X	X
Cut-leaf Coneflower (Rudbeckia laciniata)	P	L	L	T	Y	D/M	X	X		X	X						X	X	X
Compass Plant (Silphium laciniatum)	P	M	L	T	Y	D/M	X	X		X							X	X	X
Cup Plant (Silphium perfoliatum)	P	M	L	T	Y	M/W	X	X	X	X							X	X	X
Blue-eyed Grass (Sisyrinchium campestre)	P	E	R	S	B	D	X	X		X	X								
False Solomon's Seal (Smilacina racemosa)	P	E	L	S/M	W	D/M	X	X		X							X	X	X
Canada Goldenrod (Solidago canadensis)	P	L	L	T	Y	M	X	X		X	X						X	X	X
Old Field Goldenrod (Solidago nemoralis)	P	L	L	S	Y	D	X	X		X	X								
Stiff Goldenrod (Solidago rigida)	P	L	L	M/T	Y	D/M	X	X		X	X						X	X	X
Showy Goldenrod (Solidago speciosa)	P	L	R	T	Y	M	X	X		X	X						X	X	X
Germander, Wood Sage (Teucrium canadense)	P	M	L	M	W/P	M	X												X
Purple Meadow Rue (Thalictrum dasycarpum)	P	E/M	L	M	P	M/W	X	X	X	X							X	X	X
Prairie Spiderwort (Tradescantia bracteata)	P	E	R	S	B	D/M	X	X		X	X						X	X	X
Ohio Spiderwort (Tradescantia ohioensis)	P	E	L	M	B	D/M/W	X	X	X	X							X	X	X
Foary Vervain (Verbena stricta)	P	E	L	M	P/PK	D/M	X	X		X							X	X	X
Heart-leaved Alexander (Zizia aptera)	P	E	R	S	Y	D/M	X	X		X							X	X	X
Golden Alexanders (Zizia aurea)	P	E	L	M	Y	M/W	X	X	X	X							X	X	X

WETLAND SPECIES																	
GRAMINOIDS																	
Wild Calamus (Acorus calamus)	P	E	R	M	W	W				X					X	X	X
Blue Joint Grass (Calamagrostis canadensis)	P	C	R	M/T	GR-Y	M/W				X					X	X	X
Crested Sedge (Carex cristatella)	P	C	L	M	BR	M/W				X					X	X	X
Frank's Sedge (Carex frankii)	P	C	L	M	BR	M/W				X					X	X	X
Bottlebrush Sedge (Carex hystricina)	P	C	R	M	BR	M/W				X					X	X	X
Fox Sedge (Carex vulpinoidea)	P	C	L	S/M	GR	M				X					X	X	X
Saltgrass (Distichlis stricta)	P	W	R	S	G	M/S		X	X	X	X	X	X	X	X		X
Barnyard Grass (Echinochloa muricata)	P	W	L	M	GR	M/W				X					X	X	X
Blunt Spikerush (Eleocharis obtusa)	P	C	L	S	BR	M/W				X					X	X	X
Pale Spikerush (Eleocharis macrostachya)	P	C	R	S	BR	M/W				X					X	X	X
Fowl Manna Grass (Glyceria striata)	P	W	L	M/T	GR	W				X					X	X	X
Blueflag (Iris virginica)	P	C	R	S/M	B	M/W				X					X	X	X
Path Rush (Juncus interior)	P	C	L	S	BR	M/W				X					X	X	X
Torrey's Rush (Juncus torreyi)	P	C	R	S	BR	M/W				X					X	X	X
Rice Cutgrass (Leersia oryzoides)	P	C	L	S	GR	M/W				X					X	X	X
Dark Green Rush (Scirpus atrovirens)	P	C	L	M	GR	M/R				X					X	X	X
Softstem Bulrush (Scirpus validus)	P	C	L	T	GR	M/W				X					X	X	X
River bulrush (Scirpus fluviatilis)	P	C	R	T	GR	M/W				X					X	X	X
Common Bur Reed (Sparganium eurycarpum)	P	C	R	M/T	BR	W				X					X	X	X
FORBS																	
Canada anemone (Anemone canadensis)	P	E	L	S	W	M/W	X	X	X	X					X	X	X
Swamp Milkweed (Asclepias incarnata)	P	M	R	T	P/PK	M/W	X	X	X	X					X	X	X
Nodding Beggar-ticks (Bidens cernuus)	P	M	L	M	Y	W	X		X	X					X	X	X
Water Hemlock (Cicuta maculata)	P	L	L	T	Y	W									X	X	X
Boneset (Eupatorium perfoliatum)	P	L	L	T	W	W				X					X	X	X
Cardinal Flower (Lobelia cardinalis)	P	M	L	M	R	M/W				X					X	X	X
Common Water Horehound (Lycopus americanus)	P	M	L	S	W	W	X	X							X	X	X
Winged Loosestripe (Lythrum alatum)	P	M	L	S	B/P	W				X					X	X	X
Field Mint (Mentha arvensis)	P	M	L	S	W	M/W				X					X	X	X
American Lotus (Nelumbo lutea)	P	M	R	S	W	W									X		X
Smartweed (Polygonum spp.)	P	EML	L	S/T	BR	M/W				X					X	X	X
Common Mountain Mint (Pycnanthemum virginianum)	P	M	R	M	W	M/W	X	X	X	X					X	X	X
Arrowhead (Sagittaria latifolia)	P	M	L	S/M	W	M/W									X	X	X
Hemlock Water Parsnip (Sium suave)	P	M	R	T	GR-W	M/W				X					X	X	X
Blue Vervain (Verbena hastata)	P	M	L	S	P/B	M/W	X	X	X	X					X	X	X
Iron Weed (Vernonia fasciculata)	P	L	L	M	R/PK	M/W									X	X	X
Culver's Root (Veronicastrum virginicum)	P	M	L	M/T	W	M/W				X					X	X	X

TREES														
Silver Maple (Acer saccharinum)	P		R	80'	R	M/W/S	X						X	X
River Birch (Betula nigra)	P		R	50'	Br	M/W	X		X				X	X
Shagbark Hickory (Carya ovata)	P		L	60-80'	G	D/M	X							
Hackberry (Celtis occidentalis)	P		L	45-80'	G	D/M	X						X	X
Red bud (Cercis canadensis)	P		L	30'	Pl/P	D/M	X						X	X
Hazelnut (Corylus americana)	P		L	10-15'	Br	D/M	X						X	X
White Ash (Fraxinus americanum)	P		L	65-95'	W	D	X							
Green Ash (Fraxinus pennsylvanica subintegerrima)	P		L	60'	G	M/W	X						X	X
Black Walnut (Juglans nigra)	P		L	70'	W	D/M	X							X
Eastern Red Cedar (Juniperus virginiana)	P		L	50'	G/Y	D/M/S	X						X	X
Sycamore (Platanus occidentalis)	P		L	90'	W	M/W	X						X	X
Eastern Cottonwood (Populus deltoides)	P		L	70-90'	Y	D/M/S	X		X				X	X
Black Cherry (Prunus serotina)	P		L	60-90'	W	D/M	X						X	X
White Oak (Quercus alba)	P		L	60-100'	Br	D	X							X
Bur Oak (Quercus macrocarpa)	P		L	70-90'	Br	M/S	X						X	X
Pin Oak (Quercus palustris)	P		L	50-75'	Br	M/W/S	X		X				X	X
Red Oak (Quercus rubra)	P		L	70'	Br	D/M	X						X	X
Basswood (Tilia americana)	P		L	50'	Y	D/M	X						X	X
Red Elm (Ulmus rubra)	P		L	70'	Br	D/M	X						X	X

SHRUBS AND VINES																
New Jersey Tea (Ceanothus americanus)	P	E	L	3-6'	G/BR	D/M	X	X		X	X			X	X	X
Buttonbush (Cephalanthus occidentalis)	P		L	15'	W	M/W			X					X	X	X
Rough-leaved Dogwood (Cornus drummondii)	P		L	20'	W	D/M	X	X		X	X			X	X	X
Gray Dogwood (Cornus racemosa)	P		R	15'	W	D/M	X	X		X	X			X		X
Red-osier Dogwood (Cornus stolonifera)	P		R	3-19'	W	D/M	X	X	X	X	X			X		X
Wild Plum (Prunus americana)	P		L	20-30'	W	D/M	X	X		X	X			X		X
Chokecherry (Prunus virginiana)	P		L	6-10'	W	D	X	X		X				X		
Smooth Sumac (Rhus glabra)	P		L	6-15'	R	D/M	X	X		X	X			X		X
Sandbar Willow (Salix exigua)	P		L	18'	GR/Y	M/X	X		X					X	X	X
Elderberry (Sambucus canadensis)	P		L	12'	W	M	X	X	X	X	X			X		X
Coralberry, buckbrush (Symphocarpus orbiculatus)	P		L	4-6'	PK	D/M	X	X		X	X			X	X	X

Life Cycle: A – Annual; B – Biennial; or P – Perennial

Growth Height: S – Short, < 2 ft.; M – Medium, 2-4 ft.; T – Tall, >4 ft. Tree and shrub heights are given.

Color of Flower: B – Blue; BG – Blue Green; Br - Brown; G – Green; OR – Orange; P – Purple; PK – Pink; R – Red; W – White; or Y – Yellow

Site Tolerance: D – Dry; M – Moist; S – Salt; or W - Wet

Graminoids: grass-like species including grasses, sedges, bulrushes, spikerushes, rushes, irises, bur reed, etc.

Season: for Graminoids C–Cool, W–Warm

1st Flowering Date for Forbs:

E or Early--before June 1;
M or Mid--June 1 to July 31;
L or Late--August 1 and beyond

Occurrence within 50-mile radius of KCMO

L or Local: found in > 50% of counties
R or Regional: found in <50%, but >10% of counties

Example

Appendix B

Pollution Controls for “Hot Spots”

TABLE OF CONTENTS

<u>Section</u>	<u>Page</u>
B. POLLUTION CONTROLS FOR “HOT SPOTS”	B-1
B.1 Summary.....	B-1
B.1.1 Introduction and Applicability	B-1
B.2 Site Uses and Characteristics that Trigger Pollution Controls.....	B-1
B.2.1 Goals for Pollution Controls	B-1
B.2.2 Multiple Pollution Control Requirements.....	B-2
B.2.3 Additional Requirements.....	B-2
B.2.4 Fuel Dispensing Facilities	B-3
B.2.5 Aboveground Storage of Liquid Materials.....	B-3
B.2.6 Solid Waste Storage Areas, Containers, and Trash Compactors	B-5
B.2.7 Exterior Storage of Bulk Materials	B-6
B.2.8 Material Transfer Areas and Loading Docks	B-8
B.2.9 Equipment and Vehicle Washing Facilities	B-9
B.2.10 Covered vehicle parking areas	B-10
B.2.11 High-Use Vehicle and Equipment Traffic Areas, Parking, and Vehicle Storage	B-11

LIST OF TABLES

<u>Table</u>	<u>Page</u>
B.1 Bulk Material Categories	B-7

B. POLLUTION CONTROLS FOR “HOT SPOTS”

B.1 Summary

This appendix describes stormwater pollution controls for sites that generate or may generate pollutants.

To Use This Appendix:

- Determine if the project has any characteristics or site uses listed in Section B.2.0
- If so, go to the applicable section for that characteristic or site use, and follow the instructions to design pollution controls for the project.

B.1.1 Introduction and Applicability

Some site characteristics and uses may generate pollutants or levels of pollution not addressed solely by implementing pollution reduction measures described in Sections 7, 8, and 9. Site characteristics and uses in this appendix are potential sources of chronic loadings or acute releases of pollutants: oil and grease, hydrocarbons, heavy metals, toxic compounds, solvents, abnormal pH levels, nutrients, organics, bacteria, and suspended solids. This appendix offers pollution controls to manage these pollutants at their sources.

Section B.2.0 lists the site uses and characteristics subject to the requirements of this appendix. Sections B.2.4 through B.2.11 provide detailed information about the recommended pollution controls.

These pollution controls apply to all new development and redevelopment projects with the defined uses or characteristics listed in Section B.2.0. With cumulative improvements, only those areas of a structure being disturbed under the permit should undergo the structural changes identified in the pollution controls.

The pollution controls are *in addition to* the selected BMP package determined in accord with Section 4.

B.2 Site Uses and Characteristics that Trigger Pollution Controls

Projects with the following site uses and characteristics are subject to the requirements of this appendix:

- Fuel Dispensing Facilities (Section B.2.4)
- Aboveground Storage of Liquid Materials (Section B.2.5)
- Solid Waste Storage Areas, Containers, and Trash Compactors (Section B.2.6)
- Exterior Storage of Bulk Materials (Section B.2.7)
- Material Transfer Areas and Loading Docks (Section B.2.8)
- Equipment and Vehicle Washing Facilities (Section B.2.9)
- Covered Vehicle Parking Areas (Section B.2.10)
- High-Use Vehicle and Equipment Traffic Areas, Parking, and Vehicle Storage (Section B.2.11)
- Dog Kennels / Doggie Day Care, and Veterinary Clinics

B.2.1 Goals for Pollution Controls

The pollution control requirements seek the following goals:

- Prevent stormwater pollution by eliminating pathways that may introduce pollutants into stormwater.
- Protect soil, groundwater, and surface water by capturing acute releases and reducing chronic contamination of the environment.

-
- Segregate stormwater and wastewater flows to minimize additions to the sanitary and combined sewer systems.
 - Direct wastewater discharges and areas with potential for consistent wastewater discharges (such as vehicle washing facilities) to the sanitary or combined sewer system.
 - Provide an approved method of containment or disposal to areas that do not receive flow regularly or require water use and have the potential for acute releases or accidental spills.
 - Contain spills onsite.
 - Emphasize structural controls over operational procedures, because structural controls are not operator dependent and are considered to provide more permanent and reliable pollution control. Proposals for operation-based pollution controls must speak to the long-term viability of the maintenance program.
 - Furnish permanent structural solutions for the range of impacts that could result from multiple-site uses and tenant turnover.

B.2.2 Multiple Pollution Control Requirements

Applicants should address all site characteristics and uses listed in Sections B.2.4 through B.2.11. For example, if a development includes both a fuel dispensing area and a vehicle washing facility, the pollution controls in both Sections B.2.4 and B.2.9 apply.

B.2.3 Additional Requirements

Compliance with this appendix does not relieve the applicant of other applicable local, state, or federal regulatory or permit requirements. This appendix complements any additional requirements—its recommendations do not oppose, exclude, or replace those requirements. In case of a conflict, apply the more stringent local, state, or federal regulation(s).

Some common requirements are as follows:

B.2.3.1 Spill Response Supplies

Spill response supplies such as absorbent material and protective clothing should be available at all potential spill areas. Employees should be familiar with the site's operations and maintenance plan that should include proper spill cleanup procedures.

B.2.3.2 Stormwater and Wastewater Discharge Permits

Some facilities should obtain a NPDES stormwater permit before discharging to the storm sewer system or to waters of the state. Applicants also should acquire an industrial wastewater permit for discharges to the sanitary sewer system. Facilities subject to these requirements are generally commercial or industrial. Typical discharges include process wastewater, cooling water, or other discharges generated by some pollution controls described in this appendix that drain to a public sewer system (storm, sanitary, or combined). Contact the governing jurisdiction for a list of current discharge requirements.

B.2.3.3 Other Local, State, and Federal Regulations

The recommendations in this appendix do not exclude or replace requirements of other applicable codes or regulations, such as: hazardous substance storage requirements; the spill prevention control and containment (SPCC) regulations of 40 Code of Federal Regulations (CFR) 112 (U.S. Environmental Protection Agency [EPA]); the Resource Conservation and Recovery Act (RCRA); or any other applicable local, state, or federal regulations or permit requirements.

B.2.4 Fuel Dispensing Facilities

The following sections provide information about facilities that dispense fuels.

B.2.4.1 Applicability

This section applies to all development where vehicles, equipment, or tanks are refueled on the premises—whether a large-sized gas station, a single-pump maintenance yard, or a small-sized fueled tank.

A fuel dispensing facility is defined as the area where fuel is transferred from bulk storage tanks to vehicles, equipment, and mobile containers (including fuel islands, aboveground or belowground fuel tanks, fuel pumps, and the surrounding pad). Propane tanks are exempt from these recommendations.

B.2.4.2 Management Practices

The following sections describe management practices for various circumstances.

B.2.4.2.1 Cover

Cover the fuel dispensing area with a permanent canopy, roof, or awning to prevent contact between precipitation and the fueling activity area. Direct precipitation from the cover to a stormwater disposal system that meets all applicable code requirements. Covers 10 feet high or less should have a minimum overhang of 3 feet on each side. Covers higher than 10 feet should have a minimum overhang of 5 feet on each side. In each instance, measure the overhang from the perimeter of the hydraulically isolated fueling activity area.

B.2.4.2.2 Pavement

Place a paved fueling pad under and around the fueling activity area. Size the pad to cover the activity area—including area for fueling vehicles or equipment.

Gasoline and other materials can react with asphalt pavement to release oils from the pavement; therefore, pave the area with hydraulic concrete. If the area is already paved with asphalt, apply an asphalt sealant to the pavement surface. Maintain the paved surface to prevent gaps and cracks.

B.2.4.2.3 Drainage

Hydraulically isolate the paved area beneath the cover using grading, berms, or drains. This prevents uncontaminated stormwater from running onto the area and carrying away pollutants. Direct drainage from the hydraulically isolated area to an approved sanitary sewer or authorized pretreatment facility. Direct surrounding runoff away from the hydraulically isolated fueling pad to a stormwater disposal system that meets all stormwater management recommendations of this appendix.

B.2.4.2.4 Sedimentation Manhole With Tee Outlet

Install a sedimentation manhole with tee outlet on the discharge line of the fueling pad before tying in the domestic waste line. The tee section should extend 18 inches below the outlet elevation, and include an additional 4 feet of dead volume below the tee to store oil and grease. Locate the manhole on private property.

B.2.4.2.5 Shut-Off Valves

Before tying in the domestic waste line, install shut-off valves downstream of all applicable stormwater-quality facilities that serve the surrounding fueling activity areas, and downstream of the sedimentation manhole recommended for the fueling pad. Locate shut-off valves on private property.

B.2.5 Aboveground Storage of Liquid Materials

The following sections describe conditions required to store aboveground liquid materials.

B.2.5.1 Applicability

This section applies to all developments with exterior storage of liquid chemicals, food products, waste oils, solvents, or petroleum products in aboveground containers equaling or exceeding 50 gallons. This includes permanent storage and temporary storage areas.

The recommendations do not apply to underground storage tanks or to businesses permitted by the state to treat, store, or dispose of regulated substances or wastes.

Note: Storage of reactive, ignitable, or flammable liquids should comply with the Uniform Fire Code.

B.2.5.2 Management Practices

The following sections describe management practices for various circumstances.

B.2.5.2.1 Containment

Store and contain liquid materials so that if the container ruptures, the contents cannot move into a receiving system.

A device or structure to contain accidental spills should have enough capacity to capture a minimum of 110 percent of the product's largest container or 10 percent of the total volume of product stored—whichever is larger.

B.2.5.2.2 Cover

Completely cover storage containers (other than tanks) so precipitation cannot contact them. Direct precipitation from the cover to a stormwater disposal system that meets all applicable code requirements. Covers 10 feet high or less should have a minimum overhang of 3 feet on each side. Covers higher than 10 feet should have a minimum overhang of 5 feet on each side. In each instance, measure the overhang from the perimeter of the hydraulically isolated fueling activity area.

Do not cover liquid storage tanks with a canopy or roof. However, when transferring liquids or making and breaking connections, completely cover with rain shields all taps, couplings, pumps, and other potential drip, spill, and leak-prone spots. Place drip pans under the rain shields. Reuse, recycle, or appropriately dispose of any materials collected in the drip pans and any soiled absorbent materials. Record disposal locations and dates as part of the facility's operations and maintenance log.

B.2.5.2.3 Pavement

A paved storage area is recommended. Size the paved area to cover the area intended for storage.

Gasoline and other materials can react with the asphalt pavement to release toxic oils from the pavement. Therefore, pave the area with hydraulic concrete. If the area is already paved with asphalt, apply an asphalt sealant to the pavement surface. Maintain the paved surface to prevent gaps and cracks.

When an exception to the requirement is allowed, stored material must be raised from the ground by pallets or similar methods, and provisions for spill control must be established.

B.2.5.2.4 Drainage

Hydraulically isolate all paved storage areas using grading, berms, or drains to prevent uncontaminated stormwater from entering a storage area.

B.2.5.2.5 Covered Storage Areas:

Significant amounts of precipitation are not expected to accumulate in covered storage areas, and drainage facilities are not recommended for the contained area beneath the cover. The applicant electing to install drainage facilities should direct the drainage from the hydraulically isolated area to an approved sanitary sewer or authorized pretreatment facility.

B.2.5.2.6 *Uncovered Storage Areas With Containment:*

Water accumulates in uncovered storage areas during and after rain. Do not drain any *contaminated* water from the area. Collect, inspect, and possibly test it before specifying proper disposal. Monitoring the stormwater characteristics and level of contamination may also be necessary.

Discharging to the sanitary sewer may require approval, and pretreatment may be necessary. Contact the governing jurisdiction for requirements.

B.2.5.2.7 *Additional Recommendations*

Additional recommendations are as follows:

- Covered storage areas: A shut-off valve may be recommended for the covered storage area, if the applicant elects to install drainage facilities to an approved sanitary sewer.
- Uncovered storage areas: Install a shut-off valve in the storage area to drain excess stormwater from the activity area. Direct it to the storm drainage facilities (*if clean*), or into the sanitary sewer, or to the authorized pretreatment facility (*if contaminated*). Keep the valve closed to contain any spills within the activity area, except when discharging excess stormwater.
- Storage of hazardous materials: Toxic, carcinogenic, or halogenated solvents stored in designated groundwater resource protection areas are subject to additional state and federal requirements.
- Storage of reactive, ignitable, or flammable liquids: When storing these materials, comply with the Uniform Fire Code. Pollution controls in this section are to complement, not oppose, current fire code requirements.

B.2.6 **Solid Waste Storage Areas, Containers, and Trash Compactors**

The following sections furnish information about storing solid waste.

B.2.6.1 *Applicability*

The recommendations in this section apply to all developments with facilities to store solid wastes (food and non-food) outdoors in one or more solid-waste storage areas. A solid-waste storage area is where solid waste containers are stored. Solid waste containers include compactors, dumpsters, and garbage cans (including those used to contain recyclable materials).

B.2.6.2 *Management Practices*

The following sections describe management practices for various circumstances..

B.2.6.2.1 *Cover*

Permanent canopies, roofs, or awnings are recommended for solid waste storage areas containers. Construct them to cover the activity area so precipitation cannot contact stored waste materials. Direct precipitation from the cover to a stormwater disposal system that meets all applicable code requirements. Covers 10 feet high or less should have a minimum overhang of 3 feet on each side. Covers higher than 10 feet should have a minimum overhang of 5 feet on each side. In each instance, measure the overhang from the perimeter of the hydraulically isolated solid waste storage area.

Dumpsters and garbage cans used to store non-food solid waste do not require a permanent canopy, roof, or awning. Non-food solid wastes include refuse typically generated by a household or non-food-related business. Do not necessarily cover these areas structurally, but do cover them with lids. Use only leak-proof containers.

Dumpsters and garbage cans used to store food wastes and materials other than solid waste require permanent canopies, roofs, or awnings. Here "solid waste" refers to fertilizers, chemicals, and animal wastes. Food waste

refuse is typically generated by restaurants, food handlers, and other food industry businesses. Food waste includes foods not consumed by customers and excess or spoiled food.

Dumpsters and garbage cans used to store food wastes and materials other than solid wastes should be covered with permanent cover to prevent stormwater contact and minimize the quantity of stormwater entering the waste storage area. Hydraulically isolate the area beneath the cover from other portions of the site using grading, berms, or drains.

Trash compactors need not have permanent cover. But they are assessed an impervious area charge at sanitary rates for stormwater discharging to the sanitary system. The amount depends on annual rainfall data. Hydraulically isolate the area beneath the compactor from other portions of the site using grading, berms, or drains.

B.2.6.2.2 Pavement

Pave the area beneath the cover with asphalt or concrete, and meet all applicable code requirements. A paved waste storage area is recommended for waste storage areas with structural cover or use of trash compactor. Size the paved area to cover the area intended to store refuse or trash compactor(s) and associated equipment. Hydraulically isolate the area beneath the cover using grading, berms, or drains.

B.2.6.2.3 Drainage

Hydraulically isolate drainage beneath any covered area using berming, grading, or drains to prevent uncontaminated stormwater from running onto the area and carrying away pollutants. Direct drainage from the hydraulically isolated area to an approved sanitary sewer or authorized pretreatment facility. Direct surrounding runoff away from the hydraulically isolated waste storage area to a stormwater disposal system that meets all applicable code requirements.

B.2.7 Exterior Storage of Bulk Materials

The following sections discuss how to store bulk materials in outside containers.

B.2.7.1 Applicability

The recommendations in this section apply to developments that stockpile or store erodible materials in outside containers. This includes, but is not limited to, the following general categories:

- Pesticides and fertilizers
- Food items and wastes
- Scrap and recycling materials and yards
- Soil, sand, and other materials that increase total suspended solids (TSS) in stormwater (including contaminated soil)
- Raw by-product materials, waste, or final product.

Materials with any of the following characteristics are exempt from the recommendations of this section:

Have no measurable solubility or mobility in water and no hazardous, toxic, or flammable properties

Exist in a gaseous form at ambient temperature

Are contained in a manner that prevents contact with stormwater (excluding pesticides and fertilizers).

Exhibit B.2-1 (below) lists some common bulk materials. The list is separated into three categories based on risk assessments for each material stored: high-risk, low-risk, and exempt.

TABLE B.1 Bulk Material Categories		
<p>High-Risk Bulk Materials</p> <ul style="list-style-type: none"> • Recycled materials with potential effluent • Stored and processed food items • Chalk or gypsum products • Feedstock or grain • Material byproducts with potential effluent • Asphalt • Fertilizer • Pesticides • Lime or lye or soda ash • Animal or human wastes 	<p>Low-Risk Bulk Materials</p> <ul style="list-style-type: none"> • Recycled materials without potential effluent • Scrap or salvage goods • Metal • Sawdust or bark chips • Sand or dirt or soil (including contaminated soil piles) • Material byproducts without potential effluent • Unwashed gravel or rock • Compost 	<p>Exempt Bulk Materials</p> <ul style="list-style-type: none"> • Washed gravel or rock • Finished lumber • Rubber and plastic products (hoses, gaskets, pipe, and so on) • Clean concrete products (blocks, pipe, and so on) • Glass products (new, non-recycled) • Inert products

B.2.7.2 Management Practices

The following sections discuss how to manage bulk products in outside containers.

B.2.7.2.1 Cover

Cover low-risk bulk materials with a temporary plastic film or sheeting (at a minimum).

Permanently cover high-risk bulk materials with a canopy or roof to prevent stormwater contact and minimize the precipitation entering the storage area. Direct precipitation from the cover to a stormwater disposal system that meets all applicable code requirements. Covers 10 feet high or less should have a minimum overhang of 3 feet on each side. Covers higher than 10 feet should have a minimum overhang of 5 feet on each side. In each instance, measure the overhang from the perimeter of the hydraulically isolated fueling activity area.

B.2.7.2.2 Pavement

Low-Risk bulk material storage areas may or may not be paved.

High-risk bulk material storage areas should be paved beneath the structural cover.

Gasoline and other materials can react with asphalt pavement to release toxic oils from the pavement. Therefore, pave the area with hydraulic concrete. If the area is already paved with asphalt, apply an asphalt sealant to the pavement surface. Maintain the paved surface to prevent gaps and cracks that could contribute to soil contamination.

B.2.7.2.3 Drainage

Protect low-risk bulk material storage areas from precipitation and erosion if materials are erodible. If materials are erodible, place a containment barrier on at least three sides of every stockpile to act as a barrier or filter for runoff.

For high-risk bulk material storage areas, hydraulically isolate the paved area beneath the structural using grading, berms, or drains to prevent uncontaminated stormwater from running onto the area and carrying away pollutants.

Since significant amounts of precipitation are not expected to accumulate in covered storage areas, drainage facilities are not recommended for the containment area beneath the cover.

B.2.7.2.4 Additional Recommendations

- Storage of pesticides and fertilizers may need to comply with specific regulations issued by the state.
- Sampling manholes or another suitable stormwater monitoring access point may be recommended to monitor stormwater runoff from the storage area. Certain types of storage activities and materials or proposed alternative pollution control may apply to this circumstance.
- Shut-off valves may be recommended for the structurally covered storage area if the applicant elects to install drainage facilities to an approved sanitary sewer.
- Storage of toxic, carcinogenic, or halogenated solvents (within designated groundwater protection areas) is subject to additional state and federal requirements.

B.2.8 Material Transfer Areas and Loading Docks

B.2.8.1 Applicability

The following sections provide information about material transfer areas and loading docks.

The recommendations in this section apply to all developments proposing to install new material transfer areas or structural alternatives to existing material transfer areas (such as access ramp regrading or leveler installations).

Two standard types of material transfer areas associated with buildings are: 1) Loading or unloading facilities with docks, and 2) large bay doors without docks. The recommendations apply to these material transfer areas and any other building access point(s) with both of the following characteristics:

- The area is designed with the size and width to accommodate a truck or trailer backing up to or into it.
- The area will receive or distribute materials to and from trucks or trailers.

The recommendations may not apply to areas used only for mid-sized to small-sized passenger vehicles and restricted (by lease agreements or other regulatory requirements) to storing, transporting, or using materials classified as domestic use. Examples of domestic uses include primary educational facilities (elementary, middle, or high school), buildings used for temporary storage (a lease agreement must be provided), and churches.

B.2.8.2 Management Practices

The following sections discuss how to manage material transfer areas and loading docks.

B.2.8.2.1 Cover

- Existing and New Buildings with Loading Docks: Cover loading docks with a canopy, roof, or other permanent overhang that extends a minimum of 4 feet over the trailer or truck end. The cover should minimize the volume of precipitation discharged to the sanitary sewer or authorized pretreatment facility. Direct precipitation from the cover to a stormwater disposal system that meets all applicable code requirements.
- Bay Doors and Other Interior Transfer Areas: Conduct all transfer of materials with the truck or trailer end backed into the building a minimum of 5 feet (see additional recommendations below). An exterior cover is not necessary for these areas.

B.2.8.2.2 Pavement

Place a paved area underneath and around the loading and unloading activities. This reduces the potential for soil contamination that impacts groundwater and helps control any acute or chronic release of materials present in these areas.

Some materials can react with asphalt pavement to release oils from the pavement. Pave the area with hydraulic concrete. If the area is already paved with asphalt, apply an asphalt sealant to the pavement surface. Properly maintain the pavement surface to prevent gaps and cracks.

B.2.8.2.3 Drainage

- **Loading Docks:** Hydraulically isolate the first 3 feet of the paved area beneath the cover—measured from the building or dock face—using grading, berms, or drains to prevent uncontaminated stormwater from running into the area and carrying away pollutants. Direct drainage from the hydraulically isolated area to an approved sanitary sewer or authorized pretreatment facility. Direct surrounding runoff away from the hydraulically isolated loading dock area to a stormwater disposal system that meets all applicable recommendations of this appendix.
- **Bay Doors and Other Interior Transfer Areas:** Design bay doors and other interior transfer areas so stormwater does not enter the building. Grading or drains can accomplish this.

Because interior material transfer areas are not expected to accumulate precipitation, installation of floor drains is not necessary or recommended. Handle these areas with a dry mop or absorbent material. If interior floor drains are installed, they should be plumbed to an approved sanitary sewer or authorized pretreatment facility.

B.2.8.2.4 Additional Recommendations

- **Bay doors and other interior transfer areas:** These require a 10-foot “no obstruction zone” beyond the entrance within the building. This allows transfer of materials to occur with the truck or trailer end placed at least 5 feet inside the building, with an additional staging area of 5 feet beyond that. Clearly identify the “no obstruction” zone on the building plan at the time of permit application.
- **Shut-off valve:** This may be necessary for discharges to an approved sanitary sewer.
- **Transport and handling of hazardous materials:** Transport and handling of toxic, carcinogenic, or halogenated solvents are subject to additional state and federal requirements.

B.2.9 Equipment and Vehicle Washing Facilities

The following sections furnish information about equipment and vehicles washing facilities.

B.2.9.1 Applicability

The recommendations in this section apply to all development with a designated equipment and vehicle washing or steam cleaning area. This includes smaller activity areas such as wheel washing stations. Residential sites are not included.

Development intended to store 10 or more fleet vehicles should include a designated vehicle washing area—except if vehicles are routinely washed in an approved location.

B.2.9.2 Management Practices

The following sections discuss how to manage equipment and vehicle washing facilities.

B.2.9.2.1 Cover

Cover the washing area with a permanent canopy or roof so precipitation cannot come in contact with the washing activity area. Direct precipitation from the cover to a stormwater disposal system that meets all applicable code requirements. Covers 10 feet high or less should have a minimum overhang of 3 feet on each side. Covers higher

than 10 feet should have a minimum overhang of 5 feet on each side. In each instance, measure the overhang from the perimeter of the hydraulically isolated fueling activity area.

B.2.9.2.2 Pavement

Place a designated paved wash area underneath and around washing activity areas. Size the paved area to cover the activity area, including a place where the vehicle or piece of equipment is cleaned.

Some materials can react with asphalt pavement to release toxic oils from the pavement. Pave the area with hydraulic concrete. If the area is already paved with asphalt, apply an asphalt sealant to the pavement surface. Properly maintain the pavement surface to prevent gaps and cracks.

B.2.9.2.3 Drainage

Hydraulically isolate the paved area beneath the cover using grading, berms, or drains to prevent uncontaminated stormwater from running onto the area and carrying away pollutants. Direct drainage from the hydraulically isolated area to an approved sanitary sewer or authorized pretreatment facility. Direct surrounding runoff away from the hydraulically isolated washing pad to a stormwater disposal system that meets all applicable recommendations of this appendix.

B.2.9.2.4 Oil Controls

All vehicle and equipment washing activities should include oil controls. On-site wash recycling systems may be used for oil control, as long as they meet applicable effluent discharge limits for the sanitary sewer system.

B.2.9.2.5 Exceptions

- **Permanent Cover:** If a washing activity area is used generally to service oversized equipment that cannot maneuver under a roof or canopy (for instance, cranes, sail boats), a roof or canopy may not be necessary.
- **Surface Stormwater:** Because stockpile has the potential to erode, place a containment barrier on all four sides of every stockpile to prevent stormwater run-on and material runoff. Barriers can consist of concrete curbing, silt fencing, or other berming material—depending on the activity, size, and resources available.

B.2.10 Covered vehicle parking areas

The following sections deal with covered vehicle parking areas.

B.2.10.1 Applicability

The recommendations in this section apply to all development with a covered vehicle parking area, except single-family and duplex residential sites. Existing parking structures do not need retrofitting. New parking structures should meet these specifications.

B.2.10.2 Drainage

- **Top Floor Drainage of a Multi-Level Parking Structure:** Direct stormwater runoff from the top floor to a stormwater disposal system that meets all water quality recommendations of this appendix and any other applicable code requirements.
- **Lower Floor Drainage of a Multi-Level Parking Structure:** Since significant amounts of precipitation are not expected to accumulate in covered vehicle parking areas, drainage facilities are not recommended for the lower floors. If the applicant elects to install drainage facilities, direct the drainage from the lower floors to an approved sanitary sewer.
- **Adjacent Uncovered Portions of the Site:** Design surrounding uncovered portions of the site so stormwater does not enter the covered parking areas. This can be accomplished through grading or drains.

B.2.10.3 Liquid Materials Stored in Aboveground Tanks

Stormwater runoff and spills from some materials storage, use, or transportation areas have the potential to contribute chemical, physical, and biological pollutants to receiving systems; these include toxic substances, organic compounds, oil and grease, heavy metals, bacteria, nutrients, and suspended solids. These substances can enter the groundwater or surface water through acute releases or chronic loading. Potential pollutants can vary extensively in type and severity, depending on the characteristics of the stored material.

Hazardous materials are so defined if they or a constituent of them possess one of the following characteristics:

- Carcinogenicity
- Toxicity
- Presence of halogenated solvent.

B.2.11 High-Use Vehicle and Equipment Traffic Areas, Parking, and Vehicle Storage

The following sections provide information about high-use vehicle or high-risk-vehicle areas.

B.2.11.1 Applicability

The recommendations of this section apply to all types of vehicle and equipment traffic areas, parking lots, and vehicle storage (commercial, public, and private) with any of the following high-use or high-risk conditions:

- A commercial or industrial site that stores wrecked or impounded vehicles
- Sites with high likelihood of oil and grease releases (such as fast-food restaurants, vehicle repair shops, vehicle sales establishments, and vehicle-fueling service areas).

B.2.11.2 Management Practices

The following sections discuss how to manage high-use-vehicle or high-risk-vehicle areas.

- **Pavement:** Because of the potential for soil and groundwater contamination, all high-use or high-risk sites should be paved.

Gasoline and other materials can react with asphalt pavement to release toxic oils from the pavement. Pave the area with hydraulic concrete. If the area is already paved with asphalt, apply an asphalt sealant to the pavement surface. Properly maintain the pavement surface to prevent gaps and cracks.
- **Oil Water Separation:** City will generally prohibit discharge of stormwater with a visible sheen to the storm sewer system. Together with pollution reduction facilities to meet the recommendations of this appendix, oil-water separators approved by the governing municipality may be recommended to provide oil control for these areas.

Appendix C

Analysis of Treatment System Preference

ANALYSIS OF TREATMENT SYSTEM PERFORMANCE DISCLAIMER

The BMP Database (“Database”) was developed as an account of work sponsored by the Water Environment Research Foundation (WERF), the American Society of Civil Engineers (ASCE) / Environmental and Water Resources Institute (EWRI), the American Public Works Association (APWA), the Federal Highway Administration (FHWA), and U.S. Environmental Protection Agency (EPA)(collectively, the “Sponsors”). The Database is intended to provide a consistent and scientifically defensible set of data on Best Management Practice (“BMP”) designs and related performance. Although the individuals who completed the work on behalf of the Sponsors (“Project Team”) made an extensive effort to assess the quality of the data entered for consistency and accuracy, the Database information and/or any analysis results are provided on an “AS-IS” basis and use of the Database, the data information, or any apparatus, method, or process disclosed in the Database is at the user’s sole risk. The Sponsors and the Project Team disclaim all warranties and/or conditions of any kind, express or implied, including, but not limited to any warranties or conditions of title, non-infringement of a third party’s intellectual property, merchantability, satisfactory quality, or fitness for a particular purpose. The Project Team does not warrant that the functions contained in the Database will meet the user’s requirements or that the operation of the Database will be uninterrupted or error-free, or that any defects in the Database will be corrected.

UNDER NO CIRCUMSTANCES, INCLUDING CLAIMS OF NEGLIGENCE, SHALL THE SPONSORS OR THE PROJECT TEAM MEMBERS BE LIABLE FOR ANY DIRECT, INDIRECT, INCIDENTAL, SPECIAL, OR CONSEQUENTIAL DAMAGES INCLUDING LOST REVENUE, PROFIT OR DATA, WHETHER IN AN ACTION IN CONTRACT OR TORT ARISING OUT OF OR RELATING TO THE USE OF OR INABILITY TO USE THE DATABASE, EVEN IF THE SPONSORS OR THE PROJECT TEAM HAVE BEEN ADVISED OF THE POSSIBILITY OF SUCH DAMAGES.

The Project Team’s tasks have not included, and will not include in the future, recommendations of one BMP type over another. However, the Project Team's tasks have included reporting on the performance characteristics of BMPs based upon the entered data and information in the Database, including peer reviewed performance assessment techniques. Use of this information by the public or private sector is beyond the Project Team’s influence or control. The intended purpose of the Database is to provide a data exchange tool that permits characterization of BMPs solely upon their measured performance using consistent protocols for measurements and reporting information. The Project Team does not endorse any BMP over another and any assessments of performance by others should not be interpreted or reported as the recommendations of the Project Team or the Sponsors.

Analysis of Treatment System Performance Introduction The following summaries analyze available monitoring data drawn from the International Stormwater Best Management Practices (BMP) Database to determine whether any differences in treatment performance may be determined based on BMP category (e.g. detention basin, media filter, wetland basin, etc). These summaries focus on two separate data analyses:

- A data set composed of each BMP study’s average effluent event mean concentrations (EMCs) over the entire respective monitoring period, grouped by BMP category.
- A data set comprised of all of the individual effluent EMCs, grouped by BMP category.

For each water quality constituent examined, only those BMP studies reporting at least 3 influent and effluent EMCs were included in either data set. While this minimum threshold permits the actual calculation of the reported statistics (mean, median, percentiles, etc.), the robustness of such statistics is limited for these smallest samples.

The first data set (averaged EMCs) “weighs” the water quality data for each individual BMP study equally (one average EMC value per BMP study) no matter the number of events monitored, thereby placing the emphasis of the evaluation on whether similar types of BMPs at a variety of different sites achieve comparable average effluent quality. This analysis mutes the influence of individual events, and does not favor BMP studies that report a relatively large number of EMCs. The second analysis compares the distribution of effluent water quality from individual events by BMP category, thereby providing greater weight to those BMPs for which there are a larger number of EMCs reported. This represents an important distinction between the two analyses, and it is essential that interpretation of the performance summaries reflect how the data has been compiled and presented.

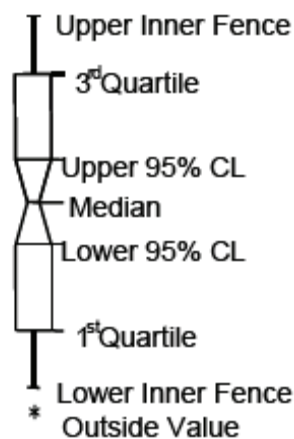

Notched box-and-whisker plots are used to graphically display the categorized distributions from both datasets. The notches encompass the 95% confidence interval of the median (averaged EMCs or individual EMCs, depending on the analysis) and provide a graphical, nonparametric means of assessing the difference between the centers of multiple distributions. A logarithmic scale was determined to be best suited for plotting the data. The log-scale boxplots were created utilizing the following method to calculate the upper and lower confidence levels:

- 1) The natural logs of the effluent values (averaged EMCs or individual EMCs, depending on the analysis) for a given BMP category are sorted in ascending order.
- 2) The upper and lower quantiles (i.e. the 75th and 25th percentiles) are calculated, following Tukey (1977).
- 3) The confidence interval of the median is calculated based on the upper and lower quantiles, following McGill et al (1978).
- 4) The median and confidence interval is translated back to arithmetic space. These values are used to delineate the upper and lower bounds of the notch on the boxplots.

For both the distributions of averaged EMCs by BMP category and the distributions of individual EMCs by BMP category, the arithmetic values of the median and associated upper confidence level (UCL) and lower confidence level (LCL) are provided in the table that accompanies each summary. An assessment was also made of the difference between the median effluent values and the corresponding influent values for both data sets. This assessment is critical, because it provides a measure of whether or not the data indicate a statistically significant difference in pollutant levels between the influent and effluent. To perform this test, the median, UCL and LCL for influent values were calculated in the same manner as for the effluent. A significant difference between the median influent and effluent values is assumed if their respective confidence intervals do not overlap; otherwise, the difference is not considered statistically significant. The same test may be performed graphically by plotting influent and effluent notched boxplots side-by-side and comparing the confidence limits visually.

In many instances, no significant difference between influent and effluent medians was determined. Therefore, it is not possible to determine with any certainty whether the BMP had an effect or simply that the characteristics of the runoff treated (for example, low influent concentrations) govern the distribution of effluent values. Where the analysis of significant difference indicates that effluent levels are greater than influent, this is noted in the text and as a footnote to the tabulated values.

References

McGill, R., J.W. Tukey, and W.A. Larsen, "Variations of Boxplots," *The American Statistician*, Vol. 32, pp.12-16, 1978.

Tukey, J. W. (1977). *Exploratory data analysis*. Reading, MA: Addison-Wesley Publishing Company.

Analysis of Treatment System Performance – Solids

Total Suspended Solids (mg/L) Total suspended solids (TSS) represents the most widely reported stormwater constituent in the International Stormwater Best Management Practices (BMP) Database. Information regarding particle size distributions or settling velocities among the studies included in the database is very limited, and no distinction based on these factors is made between BMP studies analyzed.

Analysis of Mean Effluent TSS Concentration by BMP Category (one value per BMP Study)

Average effluent TSS concentrations are significantly lower than average influent for all BMP categories analyzed except hydrodynamic devices and wetland basins. Note that the limited number of wetland channel BMPs analyzed reduces the ability to statistically determine results for this category. Median averaged effluent concentrations for detention basins, biofilters and hydrodynamic devices are above 35 mg/L, while those for media filters, retention ponds, wetland basins and wetland channels range between approximately 15 to 24 mg/L.

Media filters, biofilters and hydrodynamic devices are all primarily flow-through systems (i.e. no significant detention of flows). Of these, media filters exhibit the lowest averaged effluent. Of the storage-type categories, those which include some kind of permanent pool (retention ponds, wetland basins and wetland channels) exhibit lower effluent levels (only retention ponds achieves a strongly significant difference between influent and effluent).

Analysis of Effluent TSS Concentrations by BMP Category (all individual EMCs included in dataset)

Median effluent TSS EMCs for detention basins and hydrodynamic devices are notably higher than for the other BMP categories analyzed. In general, lower effluent TSS concentrations are observed for those categories that provide extended storage of stormwater flows (retention ponds, wetland basins).

SEE INTRODUCTION FOR
INTERPRETATION OF THESE FIGURES

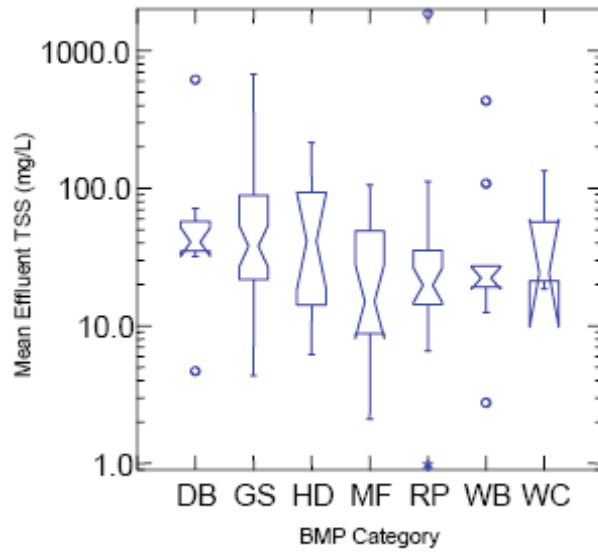

Figure 1. Mean effluent TSS concentration by BMP category

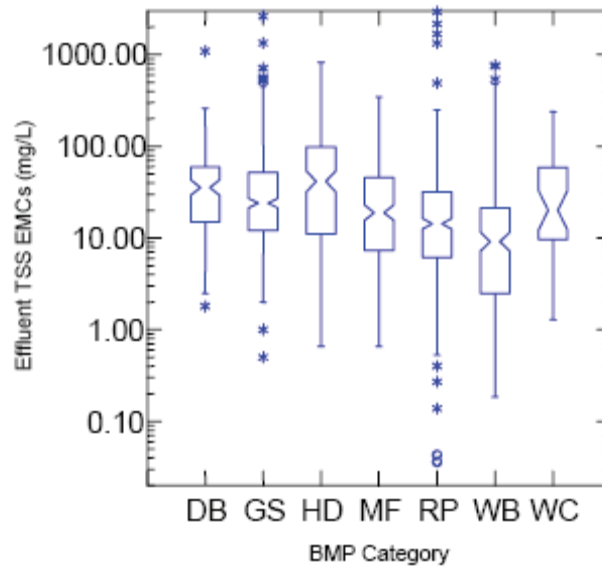

Figure 2. Individual effluent TSS EMCs by BMP category

BMP Category		Number of BMPs	Median of Avg. Effluent (95% Confidence Interval) ¹			Significant Difference Between Average Influent and Effluent ²	Median of Effluent EMCs (95% Confidence Interval) ¹			Significant Difference Between Influent and Effluent EMCs ²
			Median	LCL	UCL		Median	LCL	UCL	
DB	Detention Basin	11	40.72	32.11	51.64	YES	32.98	26.84	40.54	YES
GS	Biofilter	40	37.99	26.71	54.03	YES	24	21.34	26.99	NO
HD	Hydrodynamic Device	14	41.38	18.65	91.82	NO	36	27.58	46.99	YES
MF	Media Filter	19	15.05	8.09	28.02	YES	14.97	12.23	18.31	YES
RP	Retention Pond	24	19.77	14.74	26.51	YES	12	10.46	13.76	YES
WB	Wetland Basin	9	22.29	18.51	26.85	NO	7.55	5.93	9.6	YES
WC	Wetland Channel	3	24.18	9.83	59.45	YES	17	10.16	28.45	YES

1. Calculation of confidence interval based on McGill et al (1978), from the natural log of the quantiles.
2. Based on non-parametric analysis of difference in median values.

Analysis of Treatment System Performance – Solids

Total Dissolved Solids (mg/L)

Total dissolved solids (TDS) is a gross index for solids less than approximately 1 micron. The effectiveness of standard BMP technologies in treating TDS is limited, based on those studies available in the International Stormwater BMP Database.

Analysis of Mean Effluent TDS Concentration by BMP Category (one value per BMP Study)

No significant difference between average influent and effluent TDS concentrations are exhibited for those BMP categories with sufficient number of individual sites to permit useful analysis.

Analysis of Effluent TDS Concentrations by BMP Category (all individual EMCs included in dataset)

A significant increase between influent and effluent TDS EMCs is exhibited for biofilters, media filters and retention ponds. The remaining categories exhibit no significant difference between median influent and effluent EMCs.

SEE INTRODUCTION FOR
INTERPRETATION OF THESE FIGURES

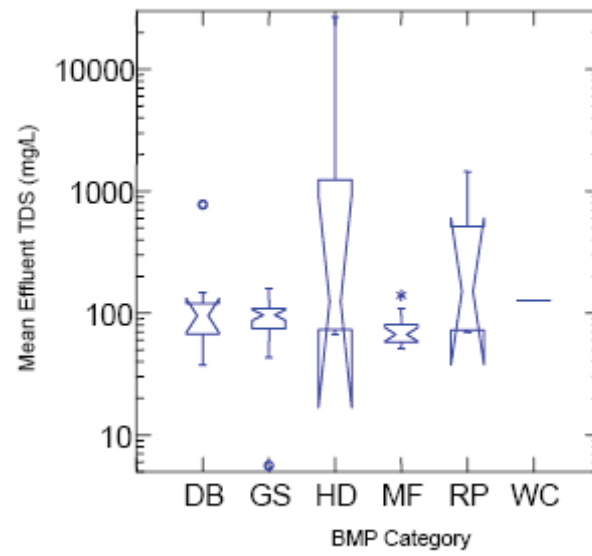

Figure 1. Mean effluent TDS concentration by BMP category

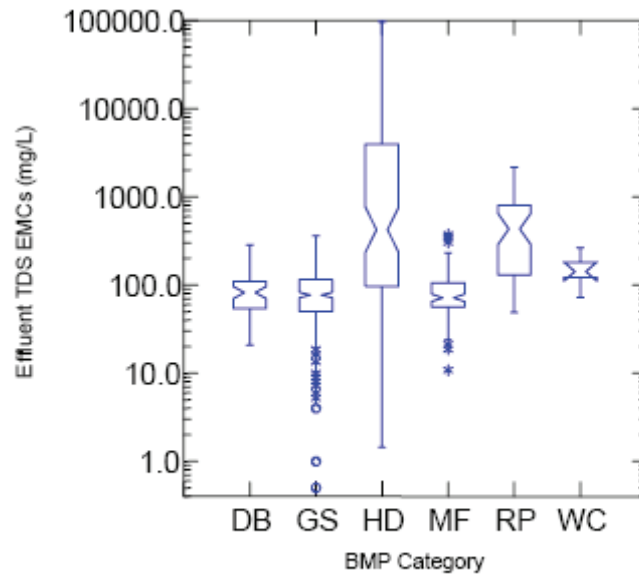

Figure 2. Individual effluent TDS EMCs by BMP category

BMP Category		Number of BMPs	Median of Avg. Effluent (95% Confidence Interval) ¹			Significant Difference Between Average Influent and Effluent ²	Median of Effluent EMCs (95% Confidence Interval) ¹			Significant Difference Between Influent and Effluent EMCs ²
			Median	LCL	UCL		Median	LCL	UCL	
DB	Detention Basin	8	64.39	33.07	125.39	NO	82	69.83	96.29	NO
GS	Biofilter	36	55.56	37.23	82.91	NO	77	71.67	82.72	YES ³
HD	Hydrodynamic Device	5	63.75	9.3	437.24	NO	350.93	191.55	642.92	NO
MF	Media Filter	16	55.76	50.32	61.78	NO	56	50.59	61.99	YES ³
RP	Retention Pond	5	142.31	36.65	552.62	NO	359.09	235.57	547.39	YES ³
WC	Wetland Channel	1	Insufficient sample size for analysis.				113.98	95.07	136.86	NO

1. Calculation of confidence interval based on McGill et al (1978), from the natural log of the quantiles.
2. Based on non-parametric analysis of difference in median values.
3. Indicates that effluent is significantly greater than influent.

Analysis of Treatment System Performance – Solids

